

USER'S MANUAL

notebook



Notice

The company reserves the right to revise this publication or to change its contents without notice. Information contained herein is for reference only and does not constitute a commitment on the part of the manufacturer or any subsequent vendor. They assume no responsibility or liability for any errors or inaccuracies that may appear in this publication nor are they in anyway responsible for any loss or damage resulting from the use (or misuse) of this publication.

This publication and any accompanying software may not, in whole or in part, be reproduced, translated, transmitted or reduced to any machine readable form without prior consent from the vendor, manufacturer or creators of this publication, except for copies kept by the user for backup purposes.

Brand and product names mentioned in this publication may or may not be copyrights and/or registered trademarks of their respective companies. They are mentioned for identification purposes only and are not intended as an endorsement of that product or its manufacturer.

©August 2013

Trademarks

Intel and **Intel Core** are trademarks/registered trademarks of Intel Corporation.

Preface

R&TTE Directive

This device is in compliance with the essential requirements and other relevant provisions of the R&TTE Directive 1999/5/EC.

This device will be sold in the following EEA countries: Austria, Italy, Belgium, Liechtenstein, Denmark, Luxembourg, Finland, Netherlands, France, Norway, Germany, Portugal, Greece, Spain, Iceland, Sweden, Ireland, United Kingdom, Cyprus, Czech Republic, Estonia, Hungary, Latvia, Lithuania, Malta, Slovakia, Poland, Slovenia.

CE Marking

This device has been tested to and conforms to the regulatory requirements of the European Union and has attained CE Marking. The CE Mark is a conformity marking consisting of the letters “CE”. The CE Mark applies to products regulated by certain European health, safety and environmental protection legislation. The CE Mark is obligatory for products it applies to: the manufacturer affixes the marking in order to be allowed to sell his product in the European market.

This product conforms to the essential requirements of the R&TTE directive 1999/5/EC in order to attain CE Marking. A notified body has determined that this device has properly demonstrated that the requirements of the directive have been met and has issued a favorable certificate of expert opinion. As such the device will bear the notified body number 0560 after the CE mark.

The CE Marking is not a quality mark. Foremost, it refers to the safety rather than to the quality of a product. Secondly, CE Marking is mandatory for the product it applies to, whereas most quality markings are voluntary.

FCC Statement (Federal Communications Commission)

You are cautioned that changes or modifications not expressly approved by the party responsible for compliance could void the user's authority to operate the equipment.

This equipment has been tested and found to comply with the limits for a Class B digital device, pursuant to Part 15 of the FCC Rules. These limits are designed to provide reasonable protection against harmful interference in a residential installation. This equipment generates, uses and can radiate radio frequency energy and, if not installed and used in accordance with the instructions, may cause harmful interference to radio communications. However, there is no guarantee that interference will not occur in a particular installation. If this equipment does cause harmful interference to radio or television reception, which can be determined by turning the equipment off and on, the user is encouraged to try to correct the interference by one or more of the following measures:

- Re orient or relocate the receiving antenna.
- Increase the separation between the equipment and receiver.
- Connect the equipment into an outlet on a circuit different from that to which the receiver is connected.
- Consult the service representative or an experienced radio/TV technician for help.

Operation is subject to the following two conditions:

1. This device may not cause interference.
And
2. This device must accept any interference, including interference that may cause undesired operation of the device.

FCC RF Radiation Exposure Statement:

1. This Transmitter must not be co-located or operating in conjunction with any other antenna or transmitter.
2. This equipment complies with FCC RF radiation exposure limits set forth for an uncontrolled environment. This equipment should be installed and operated with a minimum distance of 20 centimeters between the radiator and your body.



Warning

Use only shielded cables to connect I/O devices to this equipment. You are cautioned that changes or modifications not expressly approved by the manufacturer for compliance with the above standards could void your authority to operate the equipment.

ErP Off Mode Power Consumption Statement:

The figures below note the power consumption of this computer in compliance with European Commission (EC) regulations on power consumption in off mode

- Off Mode <math>< 0.5W</math>

IMPORTANT SAFETY INSTRUCTIONS

Follow basic safety precautions, including those listed below, to reduce the risk of fire, electric shock, and injury to persons when using any electrical equipment:

1. Do not use this product near water, for example near a bath tub, wash bowl, kitchen sink or laundry tub, in a wet basement or near a swimming pool.
2. Avoid using this equipment with a telephone line (other than a cordless type) during an electrical storm. There may be a remote risk of electrical shock from lightning.
3. Do not use the telephone to report a gas leak in the vicinity of the leak.
4. Use only the power cord and batteries indicated in this manual. Do not dispose of batteries in a fire. They may explode. Check with local codes for possible special disposal instructions.
5. This product is intended to be supplied by a Listed Power Unit (Full Range AC/DC Adapter - AC Input 100 - 240V, 50 - 60Hz DC Output 19.5V, 16.9A (**330W**) minimum).

This Computer's Optical Device is a Laser Class 1 Product

Instructions for Care and Operation

The notebook computer is quite rugged, but it can be damaged. To prevent this, follow these suggestions:





1. **Don't drop it, or expose it to shock.** If the computer falls, the case and the components could be damaged.

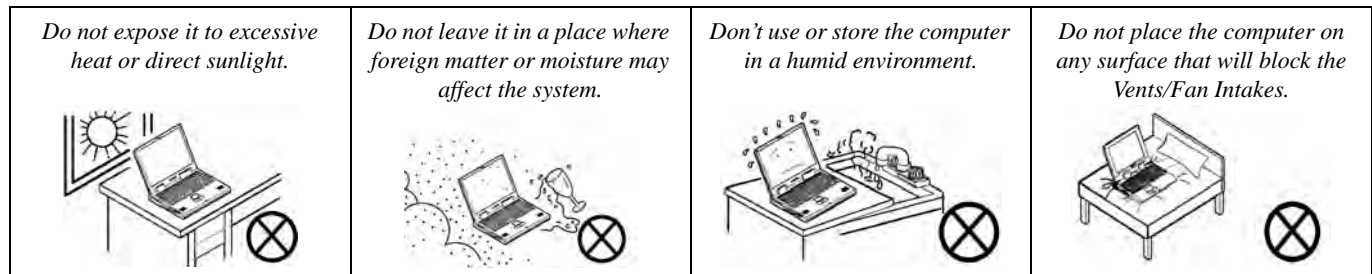



2. **Keep it dry, and don't overheat it.** Keep the computer and power supply away from any kind of heating element. This is an electrical appliance. If water or any other liquid gets into it, the computer could be badly damaged.



3. **Avoid interference.** Keep the computer away from high capacity transformers, electric motors, and other strong magnetic fields. These can hinder proper performance and damage your data.
4. **Follow the proper working procedures for the computer.** Shut the computer down properly and don't forget to save your work. Remember to periodically save your data as data may be lost if the battery is depleted.

| | | | |
|--|---|---|---|
| <p><i>Do not turn off the power until you properly shut down all programs.</i></p>  | <p><i>Do not turn off any peripheral devices when the computer is on.</i></p>  | <p><i>Do not disassemble the computer by yourself.</i></p>  | <p><i>Perform routine maintenance on your computer.</i></p>  |
|--|---|---|---|

5. **Take care when using peripheral devices.**

| | |
|--|---|
| <p><i>Use only approved brands of peripherals.</i></p>  | <p><i>Unplug the power cord before attaching peripheral devices.</i></p>  |
|--|---|

Power Safety

The computer has specific power requirements:



Power Safety Warning

Before you undertake any upgrade procedures, make sure that you have turned off the power, and disconnected all peripherals and cables (including telephone lines and power cord).

You must also remove your battery in order to prevent accidentally turning the machine on. **Before removing the battery disconnect the AC/DC adapter from the computer.**

- Only use a power adapter approved for use with this computer.
- Your AC/DC adapter may be designed for international travel but it still requires a steady, uninterrupted power supply. If you are unsure of your local power specifications, consult your service representative or local power company.
- The power adapter may have either a 2-prong or a 3-prong grounded plug. The third prong is an important safety feature; do not defeat its purpose. If you do not have access to a compatible outlet, have a qualified electrician install one.
- When you want to unplug the power cord, be sure to disconnect it by the plug head, not by its wire.
- Make sure the socket and any extension cord(s) you use can support the total current load of all the connected devices.
- Before cleaning the computer, make sure it is disconnected from any external power supplies (i.e. AC/DC adapter or car adapter).

Do not plug in the power cord if you are wet.



Do not use the power cord if it is broken.

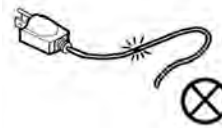

Do not place heavy objects on the power cord.

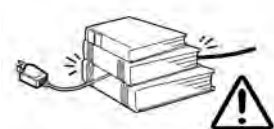

Polymer Battery Precautions

Note the following information which is specific to polymer batteries only, and where applicable, this overrides the general battery precaution information overleaf.

- Polymer batteries may experience a slight expansion or swelling, however this is part of the battery's safety mechanism and is not a cause for concern.
- Use proper handling procedures when using polymer batteries. Do not use polymer batteries in high ambient temperature environments, and do not store unused batteries for extended periods.

See also the general battery precautionary information overleaf for further information.

Battery Precautions

- Only use batteries designed for this computer. The wrong battery type may explode, leak or damage the computer.
- Do not remove any batteries from the computer while it is powered on.
- Do not continue to use a battery that has been dropped, or that appears damaged (e.g. bent or twisted) in any way. Even if the computer continues to work with a damaged battery in place, it may cause circuit damage, which may possibly result in fire.
- If you do not use the battery for an extended period, then remove the battery from the computer for storage.
- Recharge the batteries using the notebook's system. Incorrect recharging may make the battery explode.
- Do not try to repair a battery pack. Refer any battery pack repair or replacement to your service representative or qualified service personnel.
- Keep children away from, and promptly dispose of a damaged battery. Always dispose of batteries carefully. Batteries may explode or leak if exposed to fire, or improperly handled or discarded.
- Keep the battery away from metal appliances.
- Affix tape to the battery contacts before disposing of the battery.
- Do not touch the battery contacts with your hands or metal objects.



Battery Disposal & Caution

The product that you have purchased contains a rechargeable battery. The battery is recyclable. At the end of its useful life, under various state and local laws, it may be illegal to dispose of this battery into the municipal waste stream. Check with your local solid waste officials for details in your area for recycling options or proper disposal.

Danger of explosion if battery is incorrectly replaced. Replace only with the same or equivalent type recommended by the manufacturer. Discard used battery according to the manufacturer's instructions.

Cleaning

Do not apply cleaner directly to the computer; use a soft clean cloth.

Do not use volatile (petroleum distillates) or abrasive cleaners on any part of the computer.

Servicing

Do not attempt to service the computer yourself. Doing so may violate your warranty and expose you and the computer to electric shock. Refer all servicing to authorized service personnel. Unplug the computer from the power supply. Then refer servicing to qualified service personnel under any of the following conditions:

- When the power cord or AC/DC adapter is damaged or frayed.
- If the computer has been exposed to rain or other liquids.
- If the computer does not work normally when you follow the operating instructions.
- If the computer has been dropped or damaged (do not touch the poisonous liquid if the LCD panel breaks).
- If there is an unusual odor, heat or smoke coming from your computer.



Removal Warning

When removing any cover(s) and screw(s) for the purposes of device upgrade, remember to replace the cover(s) and screw(s) before restoring power to the system.

Also note the following when the cover is removed:

- Hazardous moving parts.
- Keep away from moving fan blades.

Travel Considerations

Packing

As you get ready for your trip, run through this list to make sure the system is ready to go:

1. Check that the battery pack and any spares are fully charged.
2. Power off the computer and peripherals.
3. Close the display panel and make sure it's latched.
4. Disconnect the AC/DC adapter and cables. Stow them in the carrying bag.
5. The AC/DC adapter uses voltages from 100 to 240 volts so you won't need a second voltage adapter. However, check with your travel agent to see if you need any socket adapters.
6. Put the notebook in its carrying bag and secure it with the bag's straps.
7. If you're taking any peripherals (e.g. a printer, mouse or digital camera), pack them and those devices' adapters and/or cables.
8. Anticipate customs - Some jurisdictions may have import restrictions or require proof of ownership for both hardware and software. Make sure your "papers" are handy.



Power Off Before Traveling

Make sure that your notebook is completely powered off before putting it into a travel bag (or any such container). Putting a notebook which is powered on in a travel bag may cause the Vents/Fan Intakes to be blocked. To prevent your computer from overheating make sure nothing blocks the Vent/Fan Intakes while the computer is in use.

On the Road

In addition to the general safety and maintenance suggestions in this preface, and Chapter 8: Troubleshooting, keep these points in mind:

Hand-carry the notebook - For security, don't let it out of your sight. In some areas, computer theft is very common. Don't check it with "normal" luggage. Baggage handlers may not be sufficiently careful. Avoid knocking the computer against hard objects.

Beware of Electromagnetic fields - Devices such as metal detectors & X-ray machines can damage the computer, hard disk, floppy disks, and other media. They may also destroy any stored data - Pass your computer and disks around the devices. Ask security officials to hand-inspect them (you may be asked to turn it on). **Note:** Some airports also scan luggage with these devices.

Fly safely - Most airlines have regulations about the use of computers and other electronic devices in flight. These restrictions are for your safety, follow them. If you stow the notebook in an overhead compartment, make sure it's secure. Contents may shift and/or fall out when the compartment is opened.

Get power where you can - If an electrical outlet is available, use the AC/DC adapter and keep your battery(ies) charged.

Keep it dry - If you move quickly from a cold to a warm location, water vapor can condense inside the computer. Wait a few minutes before turning it on so that any moisture can evaporate.

Developing Good Work Habits

Developing good work habits is important if you need to work in front of the computer for long periods of time. Improper work habits can result in discomfort or serious injury from repetitive strain to your hands, wrists or other joints. The following are some tips to reduce the strain:



- Adjust the height of the chair and/or desk so that the keyboard is at or slightly below the level of your elbow. Keep your forearms, wrists, and hands in a relaxed position.
- Your knees should be slightly higher than your hips. Place your feet flat on the floor or on a footrest if necessary.
- Use a chair with a back and adjust it to support your lower back comfortably.
- Sit straight so that your knees, hips and elbows form approximately 90-degree angles when you are working.
- Take periodic breaks if you are using the computer for long periods of time.



Remember to:

- Alter your posture frequently.
- Stretch and exercise your body several times a day.
- Take periodic breaks when you work at the computer for long periods of time. Frequent and short breaks are better than fewer and longer breaks.

Lighting

Proper lighting and a comfortable viewing angle can reduce eye strain and shoulder and neck muscle fatigue.

- Position the display to avoid glare or reflections from overhead lighting or outside sources of light.
- Keep the display screen clean and set the brightness and contrast to levels that allow you to see the screen clearly.
- Position the display directly in front of you at a comfortable viewing distance.
- Adjust the display-viewing angle to find the best position.

LCD Screen Care

To prevent **image persistence** on LCD monitors (caused by the continuous display of graphics on the screen for an extended period of time) take the following precautions:

- Set the *Windows* **Power Plans** to turn the screen off after a few minutes of screen idle time.
- Use a rotating, moving or blank screen saver (this prevents an image from being displayed too long).
- Rotate desktop background images every few days.
- Turn the monitor off when the system is not in use.

LCD Electro-Plated Logos

Note that in computers featuring a raised LCD electro-plated logo, the logo is covered by a protective adhesive. Due to general wear and tear, this adhesive may deteriorate over time and the exposed logo may develop sharp edges. Be careful when handling the computer in this case, and avoid touching the raised LCD electro-plated logo. Avoid placing any other items in the carrying bag which may rub against the top of the computer during transport. If any such wear and tear develops contact your distributor/supplier.

Contents

| | |
|---|------|
| Notice | I |
| FCC Statement | III |
| FCC RF Radiation Exposure Statement: | IV |
| ErP Off Mode Power Consumption Statement: | IV |
| Instructions for Care and Operation | VI |
| Power Safety | VIII |
| Polymer Battery Precautions | IX |
| Battery Precautions | X |
| Cleaning | XI |
| Servicing | XI |
| Travel Considerations | XII |

Quick Start Guide

| | |
|--|-----|
| Overview | 1-1 |
| Advanced Users | 1-2 |
| Beginners and Non-Advanced Users | 1-2 |
| Warning Boxes | 1-2 |
| Not Included | 1-3 |
| System Software | 1-4 |
| RAID & AHCI Setup | 1-4 |
| Model Differences | 1-5 |

Preface

| | |
|---|------|
| System Startup | 1-6 |
| LCD Panel Open - Model A | 1-7 |
| LCD Panel Open - Model B | 1-8 |
| LCD Panel Closed (Top View) - Model B | 1-9 |
| LCD Panel Open - Model C | 1-10 |
| LED Indicators | 1-11 |
| Illuminated LED Keyboard - Models A & C | 1-12 |
| Illuminated LED Keyboard - Model B | 1-13 |
| Keyboard LED Controls for Model B Computers | 1-14 |
| Keyboard Backlight LED | 1-15 |
| Effects Buttons & Help | 1-17 |
| Keyboard Shortcuts | 1-18 |
| Function Keys & Visual Indicators | 1-19 |
| Clickpad/Touchpad and Buttons/Mouse | 1-20 |
| Control Center | 1-21 |
| Front & Rear Views | 1-22 |
| Right View | 1-23 |
| Left View | 1-25 |
| Bottom View - Models A & C | 1-26 |
| Bottom View - Model B | 1-27 |
| Windows Control Panel | 1-28 |
| Windows 8 Start Screen & Desktop | 1-29 |

| | |
|-------------------------------------|------|
| Windows 8 Charms Bar | 1-33 |
| Windows 8 Control Panel | 1-35 |
| Windows 8 Taskbar | 1-38 |
| Video Features | 1-39 |
| Screen Resolution | 1-40 |
| Configuring External Displays | 1-43 |
| Power Options | 1-44 |
| Running Apps | 1-45 |

Storage Devices, Mouse & Audio

| | |
|---|------|
| Overview | 2-1 |
| Hard Disk Drive | 2-2 |
| Optical Device | 2-3 |
| Loading Discs | 2-3 |
| Handling CDs or DVDs | 2-4 |
| DVD Regional Codes | 2-5 |
| Multi-In-1 Card Reader | 2-6 |
| Audio Features | 2-7 |
| Setup for 5.1 or 7.1 Surround Sound | 2-8 |
| Setup for Audio Recording | 2-10 |
| Clickpad/Touchpad and Buttons/Mouse | 2-11 |
| Clickpad/Touchpad Sensitivity | 2-12 |

Preface

| | |
|---|------|
| Touchpad Configuration for Models A & C | 2-13 |
| Gestures and Device Settings | 2-14 |
| Touchpad Configuration for Model B | 2-20 |
| Finger Sensing Pad Configurator | 2-21 |

Power Management

| | |
|-------------------------------------|------|
| Overview | 3-1 |
| The Power Sources | 3-2 |
| AC/DC Adapter | 3-2 |
| Battery | 3-2 |
| Turning On the Computer | 3-3 |
| Power Plans | 3-4 |
| Power-Saving States | 3-6 |
| Sleep | 3-6 |
| Hibernate | 3-7 |
| Shut down | 3-7 |
| Configuring the Power Buttons | 3-8 |
| Resuming Operation | 3-10 |
| Power Conservation Modes | 3-11 |
| Battery Information | 3-13 |
| Battery Power | 3-13 |
| Conserving Battery Power | 3-14 |

Battery Life3-15
 New Battery3-15
 Recharging the Battery with the AC/DC Adapter3-15
 Proper handling of the Battery Pack3-16
 Battery FAQ3-17

Drivers & Utilities

RAID & AHCI Setup4-1
 What to Install4-1
 Driver Installation4-2
 Updating/Reinstalling Individual Drivers4-4
 User Account Control4-5
 Windows Security Message4-5
 New Hardware Found4-5
 Driver Installation Procedure4-6
 Chipset4-6
 Video (VGA) - NVIDIA4-6
 Video (VGA) - AMD4-6
 LAN4-6
 Card Reader4-7
 Touchpad (Clickpad)4-7
 Airplane4-7

Preface

| | |
|--------------------------------|------|
| Hot Key | 4-7 |
| MEI Driver | 4-7 |
| Thunderbolt Port | 4-7 |
| Audio | 4-7 |
| Windows Experience Index | 4-9 |
| Optional Drivers | 4-10 |

BIOS Utilities

| | |
|---|-----|
| Overview | 5-1 |
| The Power-On Self Test (POST) | 5-2 |
| Failing the POST | 5-3 |
| Fatal Errors | 5-3 |
| Non-Fatal Errors | 5-3 |
| The Setup Utility | 5-4 |
| Entering Setup | 5-4 |
| Setup Screens | 5-5 |
| Main Menu | 5-6 |
| System Time & Date (Main Menu) | 5-6 |
| SATA Port # (Main Menu) | 5-7 |
| System/Extended Memory (Main Menu) | 5-7 |
| BIOS Revision/ KBC/EC firmware Revision / VGA Card / VBIOS etc. (Main Menu) | 5-7 |
| Advanced Menu | 5-8 |

Intel(R) Rapid Start Technology (Advanced Menu)5-9

Intel(R) Thunderbolt (Advanced Menu)5-9

Intel(R) Anti-Theft Technology (Advanced Menu)5-9

SATA Mode (Advanced Menu)5-10

Boot Logo (Advanced Menu)5-11

Power On Boot Beep (Advanced Menu)5-11

Battery Low Alarm Beep (Advanced Menu)5-11

Security Menu5-12

Set Supervisor Password (Security Menu)5-12

Set User Password (Security Menu)5-13

Password on boot (Security Menu)5-13

Secure Boot Control (Security Menu)5-13

TPM Configuration (Security Menu)5-14

TPM State (Security Menu > Security Device Support Enabled)5-15

Pending TPM operation (Security Menu > Security Device Support Enabled & TPM State Enabled) .5-16

Boot Menu5-17

Boot Option Priorities (Boot Menu)5-18

UEFI Boot (Boot Menu)5-18

Exit Menu5-19

Upgrading The Computer

Overview6-1

Preface

| | |
|---|------|
| When Not to Upgrade | 6-2 |
| Removing the Battery | 6-4 |
| Upgrading the Optical (DVD) Device | 6-7 |
| Upgrading the Hard Disk Drive(s) | 6-8 |
| Replacing the Hard Disk Drive Bay Cover | 6-15 |
| Upgrading the System Memory (RAM) | 6-16 |
| Replacing the Component Bay Cover | 6-20 |

Modules

| | |
|---|------|
| Overview | 7-1 |
| Setting Up SATA RAID or AHCI Mode | 7-2 |
| AHCI Mode | 7-2 |
| RAID | 7-2 |
| Intel® Rapid Storage Technology Application | 7-2 |
| SATA RAID Setup Procedure (Windows 8) | 7-4 |
| IRST Driver Installation | 7-10 |
| Deleting a RAID (Windows 8) | 7-11 |
| PC Camera Module | 7-12 |
| PC Camera Audio Setup | 7-13 |
| Camera App | 7-14 |
| Taking Pictures/Capturing Video | 7-16 |
| Wireless LAN Module | 7-19 |

| | |
|--|------|
| 3rd Party 802.11b/g/n Driver Installation | 7-20 |
| Intel® WLAN Driver Installation | 7-20 |
| Qualcomm Atheros WLAN Combo Driver Installation | 7-21 |
| Qualcomm Atheros Killer Network Manager | 7-22 |
| WLAN Configuration in Windows 8 | 7-28 |
| Fingerprint Reader Module | 7-34 |
| Protector Suite Fingerprint Reader Driver Installation | 7-36 |
| BioExcess Fingerprint Reader Driver Installation | 7-36 |
| Protector Suite Application | 7-37 |
| Protector Suite - User Enrollment | 7-39 |
| Protector Suite - Fingerprint Control Center Features | 7-45 |
| BioExcess Application | 7-46 |
| Bluetooth & WLAN Combo Module | 7-57 |
| 3rd Party Bluetooth (V4.0) Combo Driver Installation | 7-58 |
| Intel Bluetooth Combo Driver Installation | 7-58 |
| Bluetooth Configuration in Windows 8 | 7-59 |
| Trusted Platform Module | 7-63 |
| Enabling & Activating TPM | 7-64 |
| Trusted Platform Module (TPM) Driver Installation | 7-66 |
| Initializing TPM | 7-67 |
| Infineon Security Platform Settings Tool | 7-69 |
| Sound Blaster Audio | 7-77 |

Preface

| | |
|---|-------|
| Sound Blaster X-Fi MB-3 Audio AP Installation | 7-77 |
| Intel® Rapid Storage Technology | 7-86 |
| IRST Driver Installation | 7-86 |
| Intel® Rapid Storage Technology for RAID Systems | 7-87 |
| RAID Volume Data Verification and Repair | 7-89 |
| Replacing and Reverting Recovery and Master Volumes | 7-89 |
| Intel® Smart Response Technology | 7-92 |
| Enabling Intel Smart Response Technology | 7-93 |
| Intel® Rapid Start Technology Driver | 7-96 |
| Intel® Rapid Start Technology Configuration | 7-97 |
| Intel® Rapid Start Technology Driver Installation | 7-103 |

Troubleshooting

| | |
|--|------|
| Overview | 8-1 |
| Basic Hints and Tips | 8-2 |
| Backup and General Maintenance | 8-3 |
| Viruses | 8-4 |
| Upgrading and Adding New Hardware/Software | 8-5 |
| Problems and Possible Solutions | 8-7 |
| Changing The SATA Mode | 8-14 |
| Changing the System from AHCI or IDE Mode to RAID Mode | 8-15 |
| Changing the System from RAID to AHCI Mode to IDE Mode | 8-21 |

Interface (Ports & Jacks)

| | |
|---------------------------|-----|
| Overview | A-1 |
| Ports and Jacks | A-2 |
| Card Reader | A-2 |
| DC-In Jack | A-2 |
| e-SATA/USB 2.0 Port | A-2 |
| HDMI-Out Port | A-2 |
| Headphone-Out Jack | A-3 |
| Line-In Jack | A-3 |
| Microphone-In Jack | A-3 |
| RJ-45 LAN Jack | A-3 |
| S/PDIF-Out Jack | A-3 |
| Security Lock Slot | A-3 |
| Thunderbolt Port | A-4 |
| USB Ports | A-5 |
| USB 3.0 Port | A-5 |

Control Center

| | |
|----------------|-----|
| Overview | B-1 |
|----------------|-----|

NVIDIA Video Driver Controls

| | |
|--|-----|
| NVIDIA Video Driver Installation | C-1 |
|--|-----|

Preface

| | |
|--|------|
| NVIDIA Control Panel | C-2 |
| Display Devices | C-5 |
| Configuring an External Display (NVIDIA) | C-6 |
| Extending the Display | C-7 |
| Multiple Display Connection to HDMI-Out Port & DisplayPort | C-10 |
| Attaching Other Displays - Devices (Charms Bar) | C-11 |
| Configuring an External Display In Windows | C-12 |
| NVIDIA® SLI Multi GPU Configuration | C-14 |
| Manage 3D Settings | C-15 |
| Adjust Video Settings | C-16 |
| HDMI Audio Configuration | C-17 |
| Audio Setup for HDMI | C-18 |
| HDMI Notes | C-20 |
| HDMI Video Configuration | C-20 |
| Sound Blaster Audio & HDMI | C-21 |
| HDCP Status | C-22 |
| NVIDIA 3D Shutter Glasses Kit | C-23 |
| Stereoscopic 3D Hardware Setup | C-24 |
| Viewing Angles | C-25 |
| Set Up Stereoscopic 3D | C-26 |

AMD Video Driver Controls

| | |
|---|------|
| AMD Video Driver Installation | D-1 |
| AMD Catalyst™ Control Center | D-2 |
| Display Devices & Options | D-7 |
| Configuring an External Display In the CCC..... | D-8 |
| Attaching Other Displays - Devices (Charms Bar) | D-12 |
| Configuring an External Display In Windows | D-13 |
| AMD CrossFireX™ Multi GPU Configuration | D-16 |
| HDMI Audio Configuration | D-17 |

Specifications

| | |
|----------------------------------|-----|
| Processor | E-2 |
| Core Logic | E-2 |
| Display | E-2 |
| Memory | E-2 |
| Video Adapter | E-2 |
| Storage | E-3 |
| Audio | E-3 |
| Keyboard & Pointing Device | E-3 |
| Interface | E-3 |
| Card Reader | E-4 |
| Slots | E-4 |

Preface

| | |
|------------------------------------|-----|
| Communication | E-4 |
| BIOS | E-4 |
| Security | E-4 |
| Operating System | E-4 |
| Design Feature | E-5 |
| Indicators | E-5 |
| Power Management | E-5 |
| Power | E-5 |
| Environmental Spec | E-5 |
| Physical Dimensions & Weight | E-5 |

Chapter 1: Quick Start Guide

Overview

This Quick Start Guide is a brief introduction to the basic features of your computer, to navigating around the computer and to getting your system started. The remainder of the manual covers the following:

- **Chapter 2** A guide to using some of the main features of the computer e.g. the **storage devices (hard disk, optical device, Multi-In-1 card reader), Game Keys, Clickpad & Mouse & Audio Features.**
- **Chapter 3** The computer's **power** management options.
- **Chapter 4** The installation of the **drivers** and utilities essential to the operation or improvement of some of the computer's subsystems.
- **Chapter 5** An outline of the computer's built-in software or **BIOS** (Basic Input Output System).
- **Chapter 6** Instructions for **upgrading** your computer.
- **Chapter 7** A quick guide to the computer's **RAID, PC Camera, Wireless LAN, Fingerprint, Bluetooth & WLAN Combo, TPM, Sound Blaster Audio** and **Intel Technology** modules (some of which may be **optional** depending on your purchase configuration).
- **Chapter 8** A **troubleshooting** guide.
- **Appendix A** Definitions of the **interface, ports/jacks** which allow your computer to communicate with external devices.
- **Appendix B** Information on the **Control Center.**
- **Appendix C** Information on the **NVIDIA** Video driver controls.
- **Appendix D** Information on the **AMD** Video driver controls.
- **Appendix E** The computer's **specification.**

Advanced Users

If you are an advanced user you may skip over most of this Quick Start Guide. However you may find it useful to refer to *“Drivers & Utilities” on page 4 - 1*, *“BIOS Utilities” on page 5 - 1* and *“Upgrading The Computer” on page 6 - 1* in the User’s Manual. You may also find the notes marked with a  of interest to you.



Notes

Check the light colored boxes with the mark above to find detailed information about the computer’s features.

Beginners and Non-Advanced Users

If you are new to computers (or do not have an advanced knowledge of them) then the information contained in this Quick Start Guide should be enough to get you up and running. Eventually you should try to look through all the documentation (more detailed descriptions of the functions, setup and system controls are covered in the remainder of the User’s Manual), but do not worry if you do not understand everything the first time. Keep this manual nearby and refer to it to learn as you go. You may find it useful to refer to the notes marked with a  as indicated in the margin. For a more detailed description of any of the interface ports and jacks see *“Interface (Ports & Jacks)” on page A - 1*.

Warning Boxes

No matter what your level please pay careful attention to the warning and safety information indicated by the  symbol. Also please note the safety and handling instructions as indicated in the *Preface*.

Not Included

Operating Systems (e.g. *Windows 8*) and applications (e.g. word processing, spreadsheet and database programs) have their own manuals, so please consult the appropriate manuals.



Drivers

If you are installing new system software, or are re-configuring your computer for a different system, you will need to install the drivers listed in ***“Drivers & Utilities” on page 4 - 1***. Drivers are programs which act as an interface between the computer and a hardware component e.g. a wireless network module. It is very important that you install the drivers in the order listed. You will be unable to use most advanced controls until the necessary drivers and utilities are properly installed. If your system hasn't been properly configured (your service representative may have already done that for you); refer to ***Chapter 4*** for installation instructions.

Ports and Jacks

See ***“Ports and Jacks” on page A - 2*** for a description of the interface (ports & jacks) which allow your computer to communicate with external devices, connect to the internet etc.

System Software

Your computer may already come with system software pre-installed. Where this is not the case, or where you are re-configuring your computer for a different system, you will find the **Windows 8 (64 bit)** operating system is supported.

Note: In order to run **Windows 8** without limitations or decreased performance, your computer requires a minimum **1GB** of system memory (RAM).



Windows 8 OS

In order to run **Windows 8 (64 bit)** without limitations or decreased performance, your computer requires a minimum **2GB** of system memory (RAM).

RAID & AHCI Setup

Note that setting up a RAID, or AHCI mode, needs to be done prior to installing the *Windows OS* (see “[Setting Up SATA RAID or AHCI Mode](#)” on page 7 - 2).

Model Differences

This notebook series includes **three** different model types that mainly differ as indicated in the table below. Note that your model may appear slightly different from those pictured in this manual.

| Feature | Model A | Model B (Including 2nd Design Style) | Model C |
|------------------------|---|--|---|
| Display Type | 17.3" (43.94cm) FHD (1920 * 1080) 16:9 Backlit Panel | | 17.3" (43.94cm) FHD (1920 * 1080) 16:9, 120Hz, Backlit Panel Built-In 3D Emitter Supports NVIDIA® 3D Vision™ Kit with 2 * Shutter Glasses |
| Video Adapters | See <i>“Video Adapter” on page E - 2</i> for more details | | |
| Microphone | Built-In Microphone | Built-In Array Microphone | Built-In Microphone |
| Touchpad/ Clickpad | Built-In Clickpad | Built-In Illuminated Touchpad | Built-In Clickpad |
| PC Camera | 2.0M FHD PC Video Camera Module | Dual Camera 5.0M Pixels / 1.0M HD PC Video Camera Module | 2.0M FHD PC Video Camera Module |
| Dimensions & Weight | See <i>“Physical Dimensions & Weight” on page E - 5</i> for more details Note that Model B computers include a 2nd Design Style for the Top Cover | | |

Table 1 - 1 - Model Differences

System Startup

1. Remove all packing materials, and place the computer on a stable surface.
2. Securely attach any peripherals you want to use with the notebook (e.g. keyboard and mouse) to their ports.
3. Attach the AC/DC adapter to the DC-In jack at the rear of the computer, then plug the AC power cord into an outlet, and connect the AC power cord to the AC/DC adapter.
4. Use one hand to raise the lid/LCD to a comfortable viewing angle (it is preferable **not to exceed 135 degrees**); use the other hand (as illustrated in [Figure 1 - 1](#) below) to support the base of the computer (**Note: Never lift the computer by the lid/LCD**).
5. Raise the lid/LCD to a comfortable viewing angle, and press the power button.



Figure 1 - 1 - Computer with AC/DC Adapter Plugged-In/Opening the Lid/LCD



Shutdown

Note that you should always shut your computer down by choosing the **Shut Down** command from the **Power** item in **Settings** in the **Charms Bar** (use the **Windows Logo Key + C** key combination to access the **Charms Bar**) in **Windows 8**. This will help prevent hard disk or system problems.

LCD Panel Open - Model A

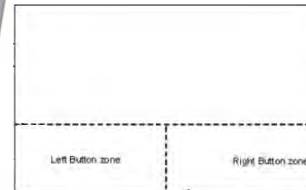
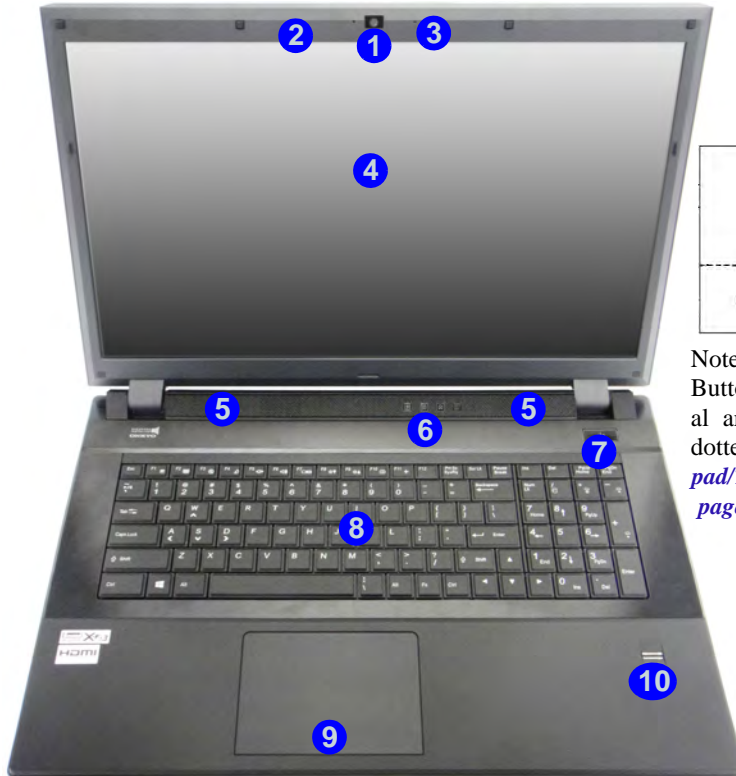

Note that the Touchpad and Buttons has a valid operational area indicated within the dotted lines above. See *“Clickpad/Touchpad Sensitivity”* on page 2 - 12.

Figure 1 - 2
LCD Panel Open
Model A

1. Built-In PC Camera
2. PC Camera LED
3. Built-In Microphone
4. LCD
5. Speakers
6. LED Status Indicators
7. Power Button
8. Keyboard
9. Clickpad and Buttons
10. Fingerprint Reader Module

Figure 1 - 3
LCD Panel Open - Model B

1. Built-In 1.0M HD PC Camera
2. PC Camera LED
3. Built-In Array Microphone
4. LCD
5. Volume Bar LED
6. Speakers
7. Power Button LED
8. LED Status Indicators
9. Illuminated Keyboard
10. Illuminated Touchpad
11. Touchpad Buttons
12. Fingerprint Reader Module

Note that the Volume Bar LED will not oscillate if the volume level is set lower than 20%

LCD Panel Open - Model B

Note that the Illuminated Touchpad has a defined valid operational area of sensitivity indicated within the sensor area of the illustration below. See *“Illuminated Touchpad Sensitivity”* on page 2 - 12.

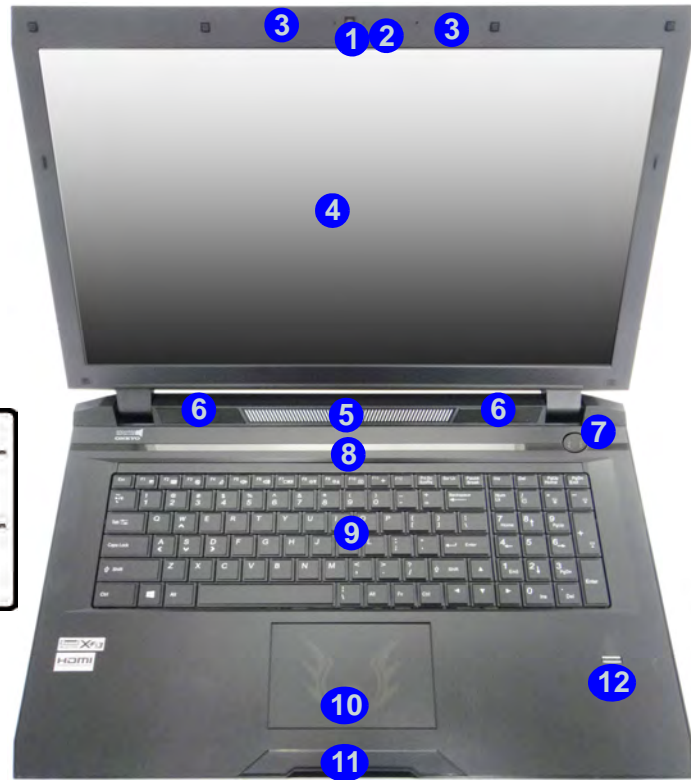
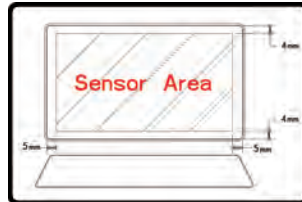

LCD Panel Closed (Top View) - Model B

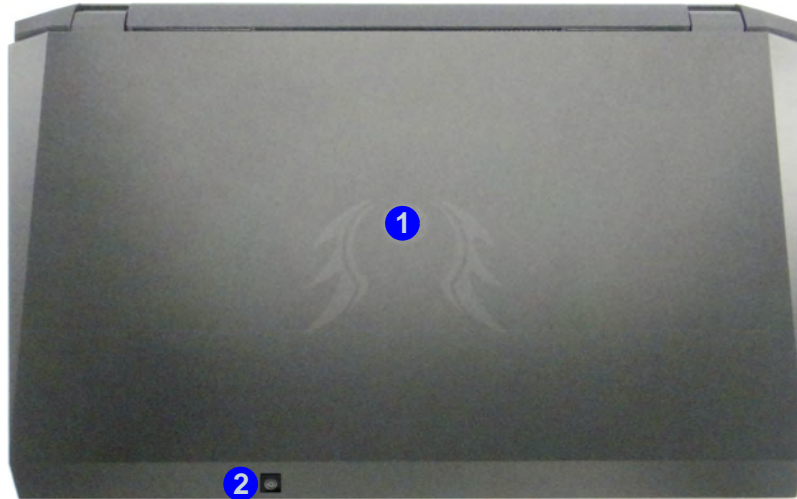

Figure 1 - 4
**LCD Panel Closed
Model B**

1. Top Case Logo LED
2. Built-In 1.0M HD PC Camera



Top Case Logo LED

Note that the top case logo LED pictured here may differ in appearance from the design on your Model B purchase option.

Note that the **Model B** computers feature a 5.0M Pixels / 1.0M HD dual camera system. When the LCD is open, the camera facing you is the 1.0M HD camera (see [Figure 1 - 3 on page 1 - 8](#)). The 5.0M Pixels camera (**2** above) is located on the top case, which will be facing away from you when the LCD panel is open.

Figure 1 - 5
LCD Panel Open - Model C

1. Built-In PC Camera
2. PC Camera LED
3. Built-In Microphone
4. LCD
5. Speakers
6. 3D Emitter
7. LED Status Indicators
8. Power Button
9. Keyboard
10. Clickpad and Buttons
11. Fingerprint Reader Module

LCD Panel Open - Model C

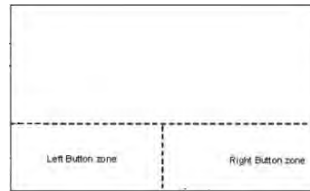



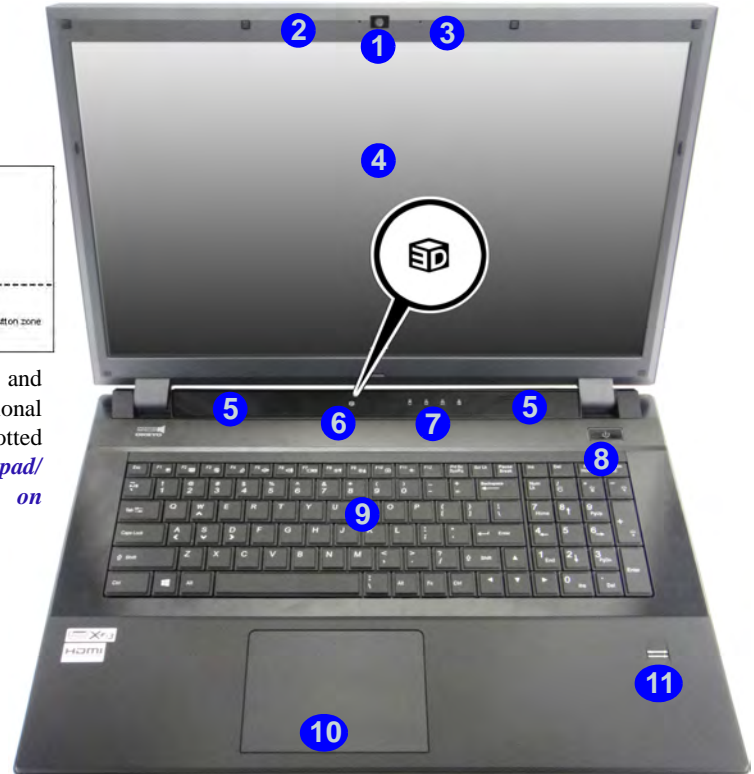









Note that the Touchpad and Buttons has a valid operational area indicated within the dotted lines above. See [“Clickpad/Touchpad Sensitivity”](#) on page 2 - 12.



LED Indicators

The LED indicators display helpful information about the current status of the computer.

| Icon | Color | Description | Icon | Color | Description |
|---|-------|---|---|-----------------|--|
|  | White | Number Lock is Activated  |  | Orange | The Battery is Charging |
|  | White | Caps Lock is Activated  | | Blinking Orange | The Battery has Reached Critically Low Power Status |
|  | White | Scroll Lock is Activated  | | Green | The Battery is Fully Charged |
|  | White | Hard Disk Activity | | Orange | AC/DC Power is Plugged In |
|  | White | Airplane Mode is ON (the WLAN & Bluetooth Modules are OFF) | | Blinking Orange | The Powered USB Port is On (see "USB 3.0 Ports & USB Port Power" on page 1 - 23) |
|  | White | Clickpad/Touchpad Activated | | Green | The Computer is On |
| | | |  | Blinking Green | The Computer is in Sleep Mode |

Wireless Device Operation Aboard Aircraft

The use of any portable electronic transmission devices (e.g. WLAN or Bluetooth) aboard aircraft is usually prohibited. Make sure any wireless modules are OFF (i.e. the system is in **Airplane Mode**) if you are using the computer aboard aircraft.

Use **Fn + F11 Airplane Mode** key combination to toggle Airplane Mode On/Off, and check the LED indicator for the power status.

Table 1 - 2 - LED Indicators



Other Keyboards

If your keyboard is damaged or you just want to make a change, you can use any standard USB keyboard. The system will detect and enable it automatically. However special functions/hot-keys unique to the system's regular keyboard may not work.

Num Lk & Scr Lk

Hold down the **Fn Key** and **Scr Lk/Num Lk** to enable scroll lock/number lock, and check the LED indicator for status.

Illuminated LED Keyboard - Models A & C

The illuminated keyboard has an embedded numerical keypad for easy numeric data input, and features function keys to allow you to change operational features instantly. See [Table 1 - 6, on page 1 - 19](#) for full function key combination details.



Figure 1 - 6 - Illuminated LED Keyboard - Models A & C



Special Characters

Some software applications allow the number-keys to be used with **Alt** to produce special characters. These special characters can only be produced by using the numeric keypad. Regular number keys (in the upper row of the keyboard) will not work. Make sure that **NumLk** is on.

Illuminated LED Keyboard - Model B

The illuminated keyboard has an embedded numerical keypad for easy numeric data input, and features function keys to allow you to change operational features instantly. See [Table 1 - 6, on page 1 - 19](#) for full function key combination details.

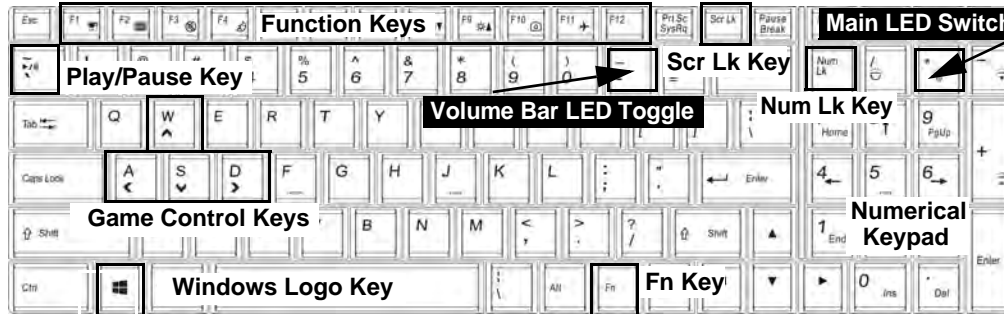

Figure 1 - 7 - Illuminated LED Keyboard - Model B

Special Characters

Some software applications allow the number-keys to be used with **Alt** to produce special characters. These special characters can only be produced by using the numeric keypad. Regular number keys (in the upper row of the keyboard) will not work. Make sure that **NumLk** is on.



Other Keyboards





If your keyboard is damaged or you just want to make a change, you can use any standard USB keyboard. The system will detect and enable it automatically. However special functions/hot-keys unique to the system's regular keyboard may not work.

Num Lk & Scr Lk



Hold down the **Fn Key** and **Scr Lk/Num Lk** to enable scroll lock/number lock, and check the LED indicator for status.

Keyboard LED Controls for Model B Computers

Note that **Model B** computers feature a series of additional LEDs, some of which can be configured by the keyboard controls and keyboard backlight application outlined on the following pages. Note the following keyboard LED features unique to **Model B** computers.

| Keyboard LED Controls for Model B Computers | |
|---|---|
| Fn +  | Main LED Switch (Toggle all LEDs On/Off) |
| Fn +  | Turn Volume Bar LED On/Off |
| <ul style="list-style-type: none"> • Use the Main LED switch to turn on/off all LEDs (except Power Button) • Use the Fn +  key combination to turn on/off the Volume Bar LED • Use the keyboard LED controls and backlight application to configure colors and effects for the Touchpad, keyboard, power button and top case logo LEDs • Note that the Volume Bar LED will not oscillate if the volume level is set lower than 20% | |
|  <p style="text-align: center;"><i>Figure 1 - 8</i> Keyboard LED Controls for Model B Computers</p> | |

Keyboard Backlight LED

Press **Fn** plus the  **2** key to toggle the keyboard LED on/off. The keyboard LED may be configured using the **Fn + key combination** outlined in the table below. In addition press **Fn** plus the  **1** key to launch the keyboard backlight application to configure the settings (see overleaf). The keyboard backlight LED may be toggled on/off by using the Control Center button (see overleaf).







| Keyboard LED Function key Combinations | | |
|--|--|--|
| Fn +  | 1 Launch the Keyboard Backlight Application |  |
| Fn +  | 2 Toggle the Keyboard Backlight On/Off (For Model B Only = Main LED Switch - All LEDs On/Off except Power Button) | |
| Fn +  | 3 Keyboard LED Illumination Decrease (for Custom Mode only - see Table 1 - 4, on page 1 - 17) | |
| Fn +  | 4 Keyboard LED Illumination Increase (for Custom Mode only - see Table 1 - 4, on page 1 - 17) | |

Table 1 - 3 - Keyboard LEDs

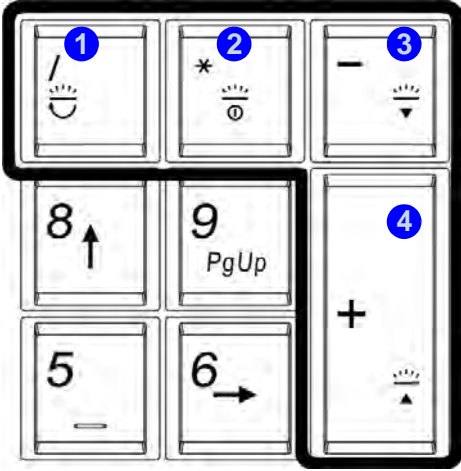
Quick Start Guide

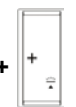
Keyboard Backlight Application

The **keyboard Backlight application** can be accessed by pressing the **Fn** plus  key. Click the **Help** button  in the application to display the configuration keys. Note this will also affect the LEDs (e.g. Touchpad, Power Button, Top Case Logo etc.) for **Model B** computers.

- Click the **Custom** button  to display the three sections of the keyboard which may be configured.
- Click a section of the keyboard and the color buttons will be displayed.
- Click a **color swatch** to apply the color to the selected section when not overridden by any effect applied.
- Click on any of the effect buttons to apply random colors, wave or flashing effects etc (see over).

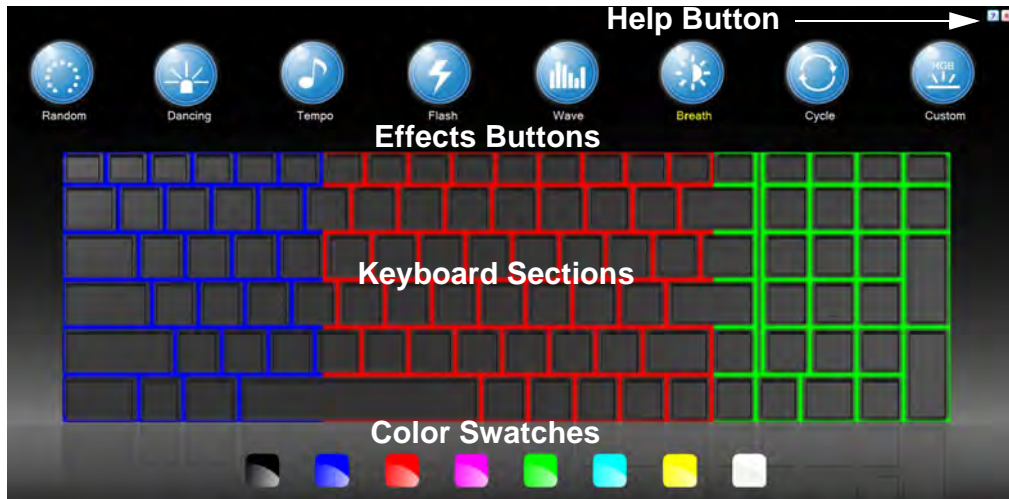











Figure 1 - 9 - Keyboard Backlight Application

Effects Buttons & Help

| LED Effects Buttons | | | |
|---|----------------|---|---|
|  | Random Color |  | Up/Down Wave |
|  | Dancing Effect |  | Breathing (All Colors) |
|  | Tempo Beat |  | Cycle (Colors as Selected in RGB) |
|  | Flashing |  | Custom Mode - Display & Configure Keyboard Sections & Colors |





Illumination Keys

Note that the keyboard illumination (increase/decrease) keys may be used to configure the keyboard LED in **Custom Mode** only.

Table 1 - 4 - LED Effects Buttons & Help



Windows Logo Keyboard Shortcut

Use the Windows logo key  + **D** key combination to switch between the Start screen and Desktop app.

Keyboard Shortcuts

The following Windows Logo Key (Winkey) keyboard shortcuts are useful for navigation/operation in *Windows 8*.

| Windows Logo  Key + | Description |
|---|---|
| Tap Winkey | Toggle between the Start screen and the foremost running app or the Windows Desktop app |
| C | Display Charms menu |
| D | Switch to the Windows Desktop app and toggle show Desktop |
| E | Switch to the Windows desktop and launch Windows Explorer with Computer displayed |
| F | Display file Search |
| I | Open the Settings charm |
| K | Open the Connect charm |
| L | Lock the computer and display the Lock screen |
| P | Display the Second Screen menu (see Figure 1 - 32 on page 1 - 43) |
| R | Switch to the Windows Desktop app and display the Run dialog box |
| Z | Access the App Bar (see Figure 1 - 21 on page 1 - 32) |

Table 1 - 5 - Keyboard Shortcuts

Function Keys & Visual Indicators

The **function keys** (F1 - F12 etc.) will act as **hot keys** when pressed while the **Fn** key is held down. Visual indicators (see the table below) are available when the Hot Key driver is installed.





| Keys | Function/Visual Indicators | Keys | Function/Visual Indicators |
|--|---|--|--|
| Fn + ~ | Play/Pause (in Audio/Video Programs) | Fn + Esc | Control Center Toggle (see over) |
| Fn + F1 | Touchpad Toggle  | Fn + F8/F9 | Brightness Decrease/Increase |
| Fn + F2 | Turn LCD Backlight Off (Press a key to or use Touchpad to turn on) | Fn + F10 | PC Camera Power Toggle  |
| Fn + F3 | Mute Toggle | Fn + F11 | Airplane Mode Toggle  |
| Fn + F4 | Sleep Toggle | Fn + Power Button | Powered USB 3.0 Port Power Toggle |
| Fn + F5/F6 | Volume Decrease/Increase | Fn +  | Keyboard LED Toggle (see page 1 - 17) |
| Fn + F7 | Display Toggle | | |
| See also Table 1 - 2, on page 1 - 11 for Number Lock , Caps Lock and Scroll Lock indicators | | | |

Table 1 - 6 - Function Keys & Visual Indicators

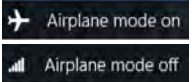

Clickpad Cleaning

In order to improve pad performance it is necessary to keep the surface clean and free of fingerprints and marks etc.

Use the cleaning cloth supplied to keep the pad surface clean.

Disabling Clickpad

Use the **Fn + F1** or Control Center button to disable the Clickpad/Touchpad.

Clickpad/Touchpad and Buttons/Mouse

The Clickpad/Touchpad is an alternative to the mouse; however, you can also add a mouse to your computer through one of the USB ports. The Clickpad/Touchpad buttons function in much the same way as a two-button mouse (see page [2 - 11](#)).

Clickpad/Touchpad Sensitivity

The mouse button zones at the bottom of the pad measure about 15mm from the bottom of the pad, and the left and right buttons are divided roughly down the middle as illustrated below. Press the left button zone for a left click, and right button zone for a right click action.

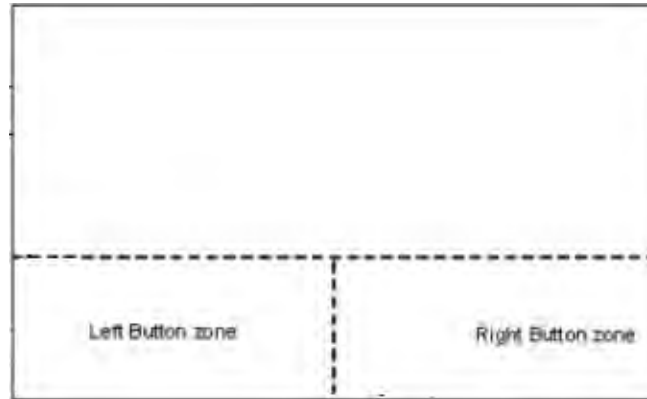



Figure 1 - 10 - Clickpad/Touchpad Sensitivity

Control Center

When in the **Windows Desktop application** (not in the **Start** screen) press the **Fn + Esc** key combination, or **double-click the icon**  in the **notification area of the taskbar** to toggle the **Control Center** on/off. The **Control Center** gives quick access to frequently used controls and enables you to quickly turn the camera/Touch Pad on/off (see [Appendix B](#) for full details).



Control Center

Click on any button to turn any of the modules (e.g. TouchPad, Camera) on/off.

Click on the power conservation modes to switch between Performance, Balanced or Energy Star modes (see page [3 - 11](#)). To remove the Power Conservation Modes screen just click in a blank area of the icon or press a key on the keyboard.

Click on the buttons (or just click and hold the mouse button) to adjust the slider for Brightness/Volume.

Click on Display Switch and click to choose a display mode from the menu (see page [C - 11](#)).



Figure 1 - 11 - Control Center

Quick Start Guide

Figure 1 - 12

Front & Rear Views

1. LED Power Indicators
2. Fan Outlet/Intake
3. HDMI-Out Port
4. USB 3.0 Port
5. DC-In Jack
6. Rear Left & Right LEDs (**Model B Only**)

See [Appendix A](#) for a more detailed description of the ports & jacks etc.

Front & Rear Views

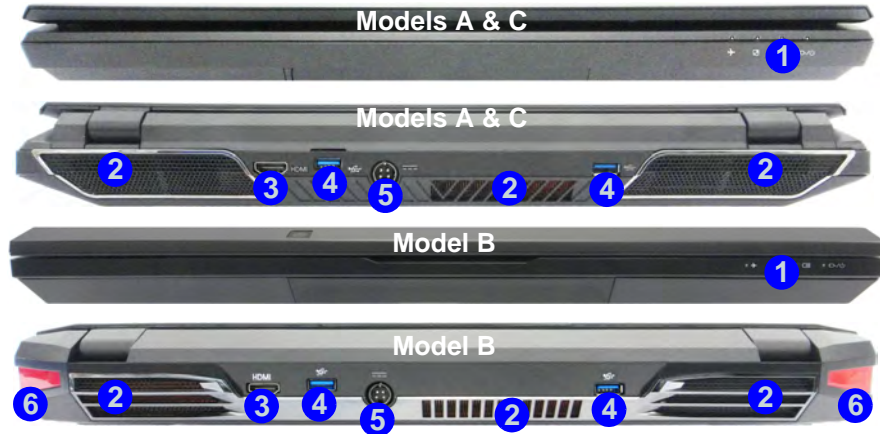

HDMI Port

Note that the HDMI Port supports video and audio signals to attached external displays (also see [“HDMI Audio Configuration” on page C - 17](#)).

USB 3.0 Ports

Note that the connections to the USB ports only fit one way, do not force them. USB 3.0 ports are denoted by their blue color; USB 2.0 ports are colored black.

See [Appendix A](#) for a more detailed description of the ports & jacks etc.

Right View

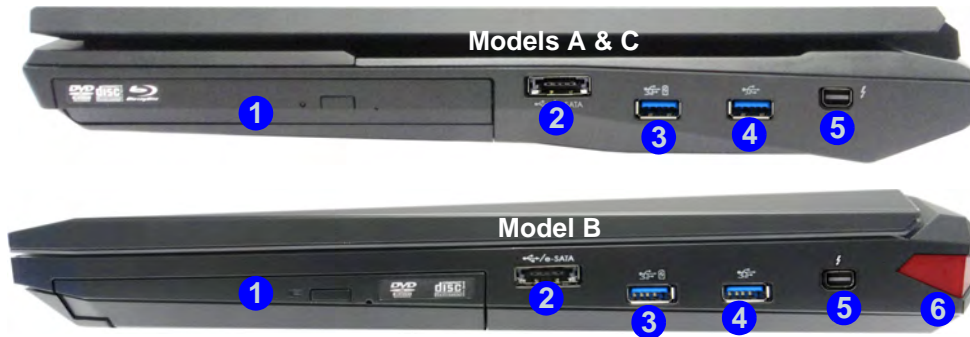

Figure 1 - 13
Right View

1. Optical Device Drive Bay
2. Combined eSATA/USB 2.0 Port
3. Powered USB 3.0 Port
4. USB 3.0 Port
5. Thunderbolt Port
6. Rear LED (**Model B Only**)



USB 3.0 Ports & USB Port Power

Note that the connections to the USB ports only fit one way, do not force them. USB 3.0 ports are denoted by their blue color; USB 2.0 ports are colored black.

The powered USB 3.0 **3** port can supply power (**for charging devices only, not for operating devices**) when the system is off but still powered by the AC/DC adapter plugged into a working outlet, or powered by the battery with a capacity level above 20% (this may not work with certain devices - see page **8 - 12**). Toggle power to this port by using **Fn + power button** (**press for around 1 to 2 seconds** to toggle).

See [Appendix A](#) for a more detailed description of the ports & jacks etc.



Ejecting Thunderbolt Devices

In order to prevent system problems make sure you **do not simply pull the cable out from the Thunderbolt port**. The hardware must be ejected safely (see "[Thunderbolt Port](#)" on page **A - 4**).



Disk Eject Warning

Don't try to eject a CD/DVD while the system is accessing it. This may cause the system to "crash". Stop the disk first then eject it, or press the stop button twice.

CD/DVD Emergency Eject

If you need to manually eject a CD/DVD (e.g. due to an unexpected power interruption) you may push the end of a straightened paper clip into the emergency eject hole. Do not use a sharpened pencil or any object that may break and become lodged in the hole. Don't try to remove a floppy disk/CD/DVD while the system is accessing it. This may cause the system to "crash".



Changing DVD Regional Codes

Go to the **Control Panel** and double-click **Device Manager (Hardware and Sound)**, then click the **+** next to **DVD/CD-ROM drives**. Double-click on the DVD-ROM device to bring up the **Properties** dialog box, and select the **DVD Region** (tab) to bring up the control panel to allow you to adjust the regional code.

DVD region detection is device dependent, not OS-dependent. You can select your module's region code **5** times. The fifth selection is permanent. This cannot be altered even if you change your operating system or you use the module in another computer.

Left View



Figure 1 - 14
Left View

1. Security Lock Slot
2. RJ-45 LAN Jack
3. Multi-In-1 Card Reader
4. Line-In Jack
5. S/PDIF-Out Jack
6. Microphone-In Jack
7. Headphone-Out Jack
8. Rear LED (**Model B Only**)



Multi-in-1 Card Reader

The card reader allows you to use the most popular digital storage card formats:

MMC (MultiMedia Card) / RSMMC
SD (Secure Digital) / Mini SD / SDHC / SDXC
MS (Memory Stick) / MS Pro / MS Duo

See [Appendix A](#) for a more detailed description of the ports & jacks etc.

Figure 1 - 15
Bottom View
Models A & C

1. Fan Outlet/Intake
2. Component Bay Cover
3. Sub Woofer
4. Battery
5. HDD Bay

Bottom View - Models A & C

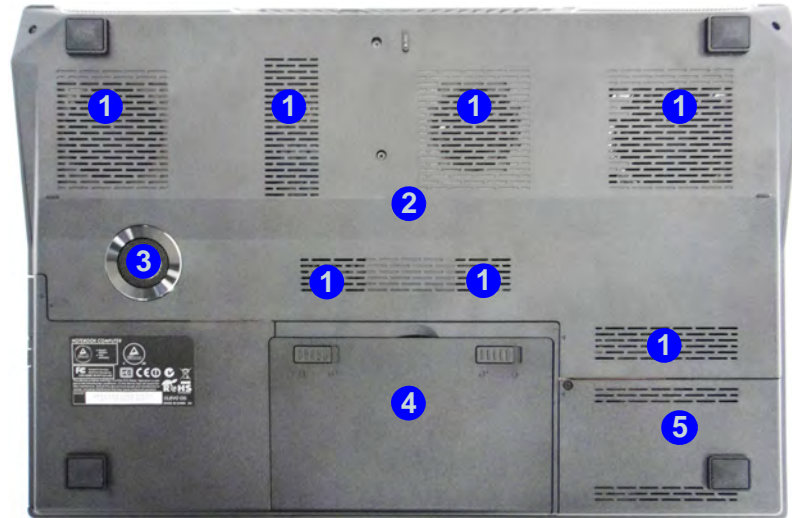

Overheating

To prevent your computer from overheating make sure nothing blocks the vent(s)/fan intake(s) while the computer is in use.



Battery Information

Always completely discharge, then fully charge, a new battery before using it. Completely discharge and charge the battery at least once every 30 days or after about 20 partial discharges. See ***"Battery Information" on page 3 - 13*** for full instructions.

Bottom View - Model B

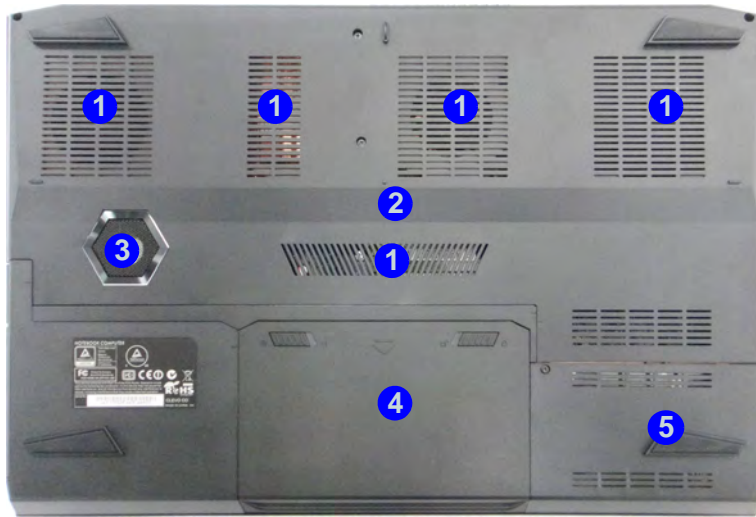

Figure 1 - 16
Bottom View
Model B

1. Fan Outlet/Intake
2. Component Bay Cover
3. Sub Woofer
4. Battery
5. HDD Bay



Battery Information

Always completely discharge, then fully charge, a new battery before using it. Completely discharge and charge the battery at least once every 30 days or after about 20 partial discharges. See ***"Battery Information" on page 3 - 13*** for full instructions.



Overheating

To prevent your computer from overheating make sure nothing blocks the vent(s)/fan intake(s) while the computer is in use.

Windows Control Panel

Throughout this manual you will see an instruction to open the **Control Panel**. In *Windows 8* right-click the lower left hot corner to bring up the context menu (or use the **Windows Logo Key**  + **X** key combination) and select **Control Panel**.

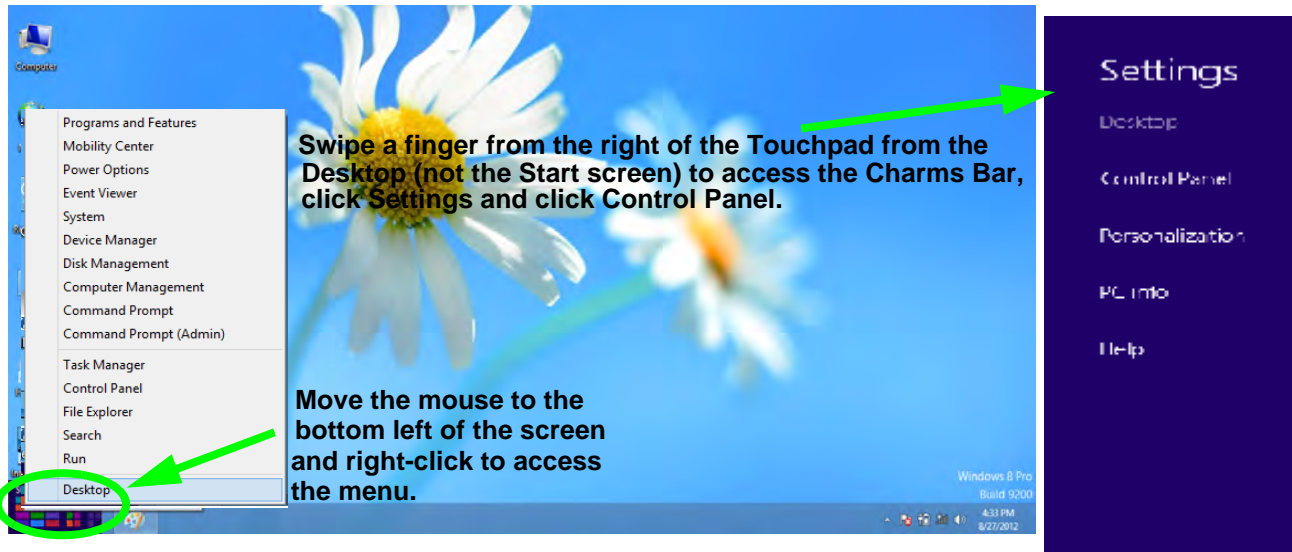

Figure 1 - 17 - Windows 8 Context Menu & Charms Bar Settings (from Desktop App)

Windows 8 Start Screen & Desktop

The Apps, control panels, utilities and programs within *Windows 8* are accessed from the **Start screen** and/or **Windows Desktop app**. The **Desktop** (which runs as an app within the **Start screen**) can be accessed by clicking the **Desktop** item in the Start screen (or by using the **Windows Logo Key**  + **D** key combination).



Figure 1 - 18 - Windows Start Screen

Quick Start Guide

Apps & Tiles

The **Windows 8** Start screen will contain a number of apps, and many more will be installed as you add more applications etc. Not all of these apps can fit on one screen so you will often need use the **slider** at the bottom of the screen in order to view all the necessary Apps.

Accessing Pining/Unpinning All Apps

You can add and remove the tiles for apps and control panels in the Start screen. **Right-click on a blank area of the Start screen**, and you will see the **All Apps** icon. Click the **All Apps** icon to display all the installed applications etc. Right-click any icon to bring up the menu at the bottom of the screen and you can then click the appropriate icon to **pin the App** to (or unpin from) the **Start** screen, or to the **taskbar** in the **Desktop application**.

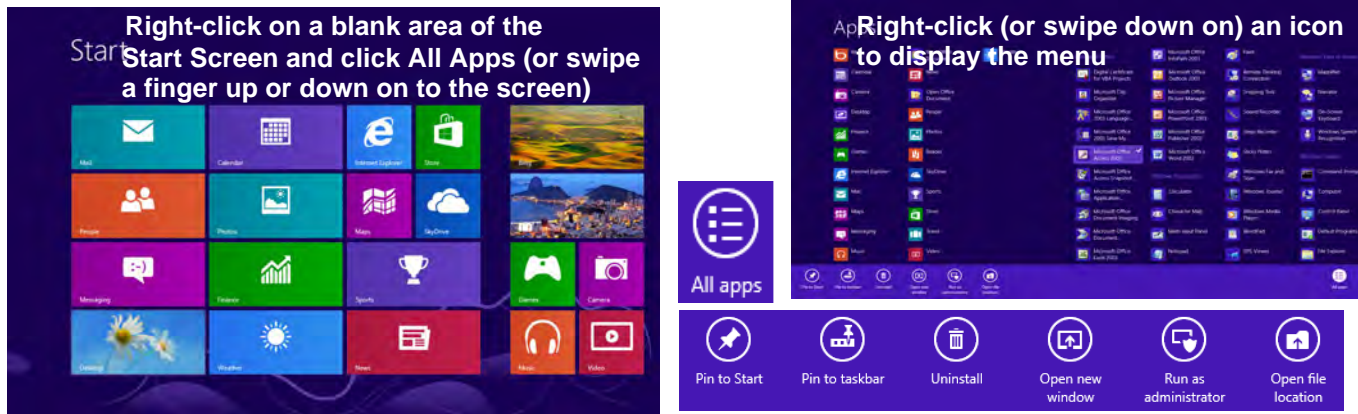



Figure 1 - 19 - All Apps

Desktop Application

When the **Desktop** app is running (click the app in the Start screen or use the **Windows Logo Key**  + **D** key combination) you can use lower left hot corner to switch between the Start screen and the **Windows Desktop** app. To do so move your mouse to hover over the bottom left corner of the screen and click the pop-up.

When you move to the lower left hot corner in the Start screen itself it will take you back to your most recently used app.

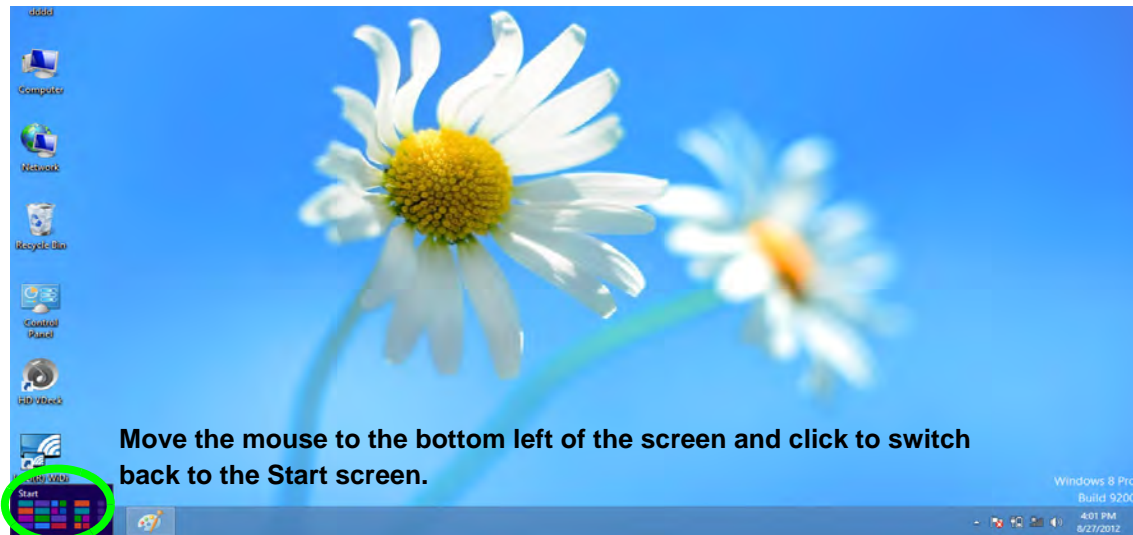

Figure 1 - 20 - Desktop

Quick Start Guide



Display Most Recently Used Apps

If you are in the **Start** screen, **Desktop** or an app you can move your mouse to the upper left corner of the screen to get back to the most recently used app.

To view all the most recently used Apps hover over the top left of the screen and then move the mouse down along the left side of the screen to display the list.

When the Desktop app is running you can right-click the lower left hot corner (or use the **Windows Logo Key**  + **X** key combination) to bring up an advanced context menu of useful features such as Control Panel, Programs and Features, Power Options, Task Manager, Search, Windows Explorer, Command Prompt, Device Manager and Network Connections etc.

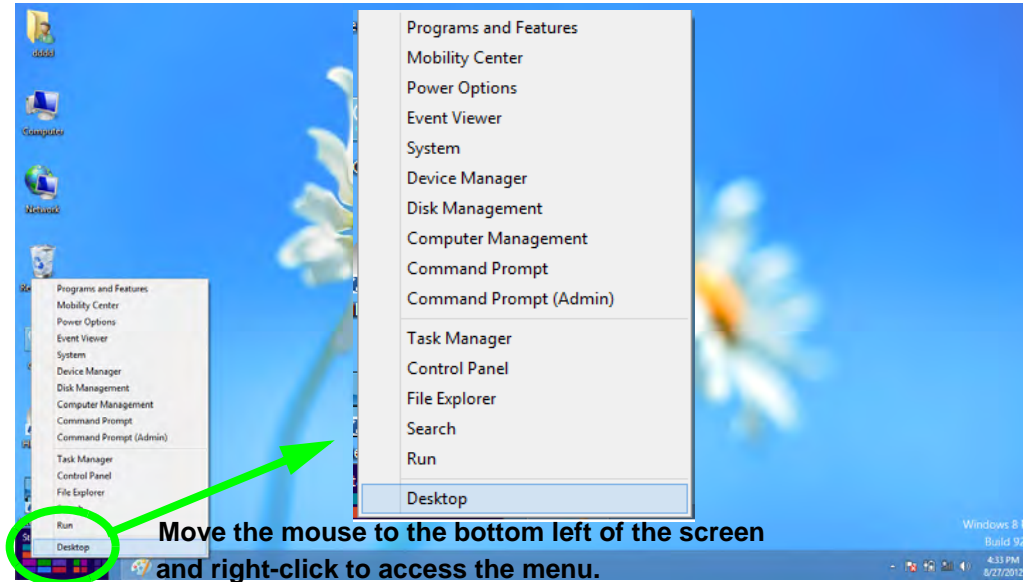

Figure 1 - 21 - Advanced Context Menu (Right-Click lower left hot corner)

Windows 8 Charms Bar







The right side of the screen displays the *Windows 8 Charms Bar*. The Charms Bar contains the **Search**, **Share**, **Start**, **Devices** and **Settings** menus. To access up the Charms Bar move the cursor to the upper or lower right corners of the screen, and then hover over one of the items in the Charms Bar to activate it (the bar will be black when it is active), or use the **Windows Logo Key**  + **C** key combination.

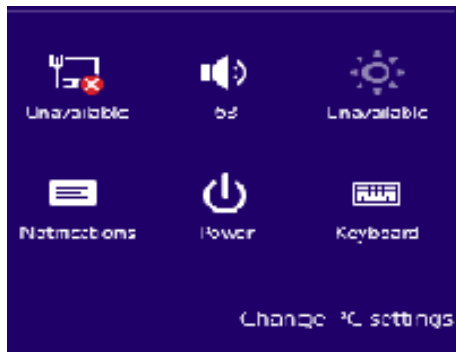



Figure 1 - 22 - Start Screen with Charms Bar

Quick Start Guide

Charms Bar Items

- **Search** : You can search for any file, application, Apps and control panel settings with instantaneous results.
- **Share** : This button is used to share information with people via mail or social networks.
- **Start** : Click to bring up the Start Menu (the same function as pressing the Windows Logo Key or clicking the bottom left of the screen).
- **Devices** : Click this button to change connected peripheral device settings e.g. an external display.
- **Settings** : This button gives instant access to the computer settings, such as Network, Audio, Notifications, Power and Keyboard (click **Change PC Settings** to activate the PC Settings menu).





Charms Bar - TouchPad Access

To quick access the **Charms Bar** using the TouchPad:

1. Place your finger **off** the TouchPad (slightly to the right of the pad resting on the computer).
2. Move your finger across to the left on to the TouchPad.
3. The Charms Bar will then pop-up.

Figure 1 - 23 - Settings Menu

Windows 8 Control Panel

In many instances throughout this manual you will see an instruction to open the **Control Panel**. The Control Panel can be accessed in a number of ways in *Windows 8*.

- Click/ **Search** in the **Windows Charms Bar** (see previous page) and the search pane will pop out. Type *Control Panel* and select it from the results to the left.



Figure 1 - 24 - Search (Control Panel)

- Click on **Computer** (you may need to pin **Computer** to the Start screen) in the **Start** screen, click on **Computer** in the top menu and select **Open Control Panel** from the ribbon.

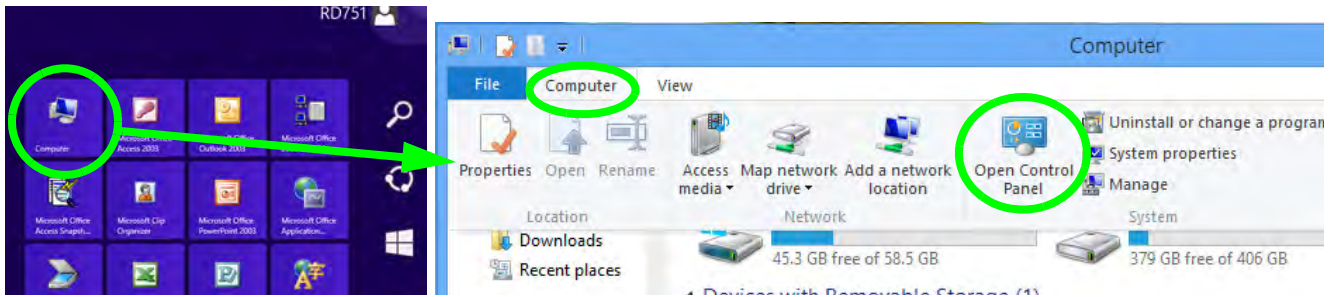

Figure 1 - 25 - Open Control Panel (Computer)

Quick Start Guide

- When in the **Desktop** app (this does not apply to the Start screen) click on **Settings** in the **Windows Charms Bar** and select **Control Panel** from the menu.

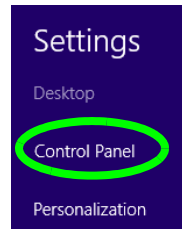

Figure 1 - 26 - Settings Charms Bar (Desktop App Only)

- Right-click on a blank area of the Start screen, or swipe a finger from the top or bottom of the touch screen.** Click the **All Apps** icon and click Control Panel.

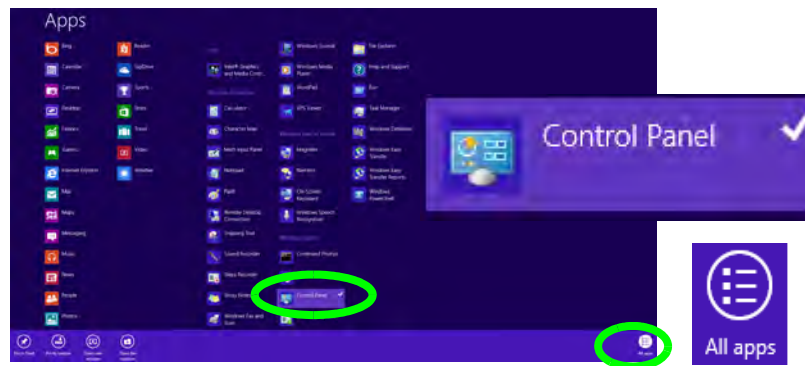



Figure 1 - 27 - All Apps - Control Panel

- Right-click the lower left hot corner to bring up the menu and select Control Panel (see *Figure 1 - 21 on page 1 - 32*).



Keyboard Shortcut to Control Panel

You can also use keyboard shortcuts to access the Control Panel. Press the **Windows logo key**  and **X** to bring up the context menu, and then press **P** to bring up the Control Panel. Alternatively press the **Windows logo key**  and **R** to bring up the **Run** dialog box, and then type **“Control Panel”** and press Enter to access the Control Panel.

Windows 8 Taskbar

In many instances throughout this manual you will see an instruction to access the **notification area of the taskbar**. In *Windows 8* the taskbar is accessed from the **Desktop** application. If you are in the Start screen you will need to click the Desktop app to switch to the Desktop.

The taskbar is displayed at the bottom of the desktop screen, and you can see the notification area of the taskbar in the bottom right of the screen. Some of the Control Panels and applications referred to during the course of this manual can be accessed from here.



Figure 1 - 28 - Desktop Taskbar

You can pin/unpin apps to/from the taskbar in much the same way as you can to the Start screen (see *[“Accessing Pining/Unpinning All Apps” on page 1 - 30](#)*).

Video Features

This computer features two different (either **NVIDIA** or **AMD**) video options. You can switch display devices, and configure display options, from the **Display** control panel (in **Appearances and Personalization**) in *Windows 8* when running the **Desktop** app (see “*Desktop Application*” on page 1 - 31).

To access **Display (Control Panel) and Screen Resolution** in *Windows 8*:

1. Go to the **Control Panel**.
2. Click **Display** (icon) - In the **Appearance and Personalization** category.
3. **Adjust resolution.**
OR
4. You can right-click the desktop and select **Screen resolution** ❶ (*Figure 1 - 29*).
5. Use the dropbox to select the screen **Resolution** ❷ (*Figure 1 - 29*).
6. Click **Advanced settings** ❸ (*Figure 1 - 29*) to bring up the **Advanced** properties tabs.



NVIDIA/AMD Video Driver Controls

More detailed video controls are provided by the **NVIDIA Control Panel** or **Catalyst Control Center**. For more detailed information see [Appendix C/Appendix D](#).

You can also access the control panels by right-clicking the desktop and selecting **NVIDIA Control Panel/Catalyst (TM) Control Center** (*Figure 1 - 30 on page 1 - 41/Figure 1 - 30 on page 1 - 41*).

Screen Resolution

Video Options

Note that card types, specifications and drivers are subject to continual updates and changes. Check with your distributor/supplier for the latest details on video cards supported.

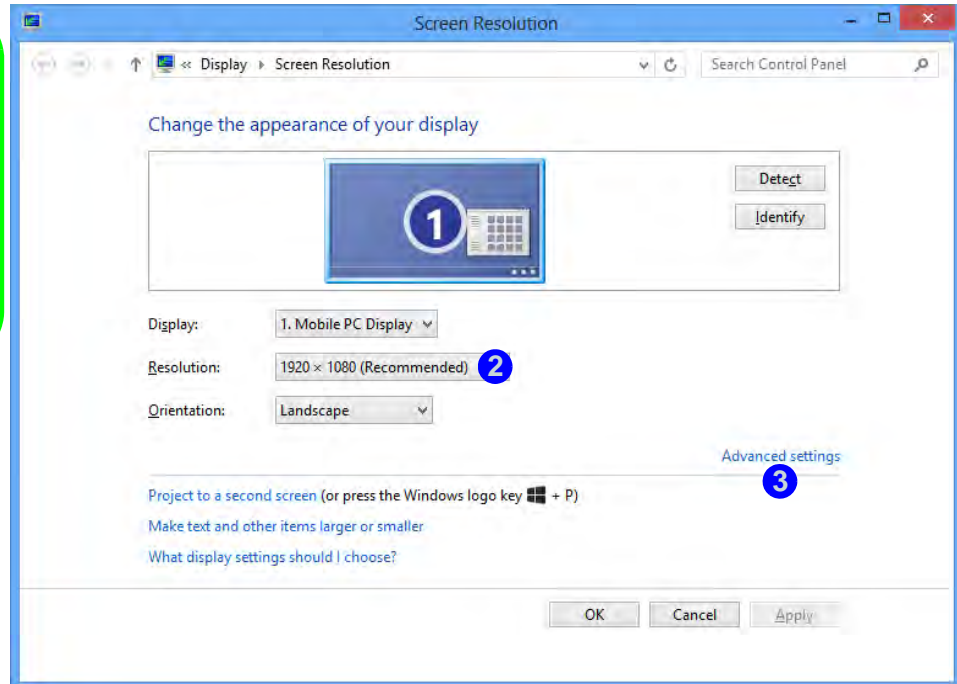
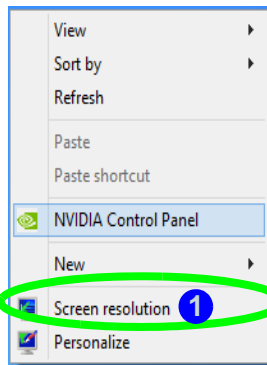

Figure 1 - 29 - Screen Resolution

To access the **NVIDIA Control Panel**:

1. Right-click the desktop and select **NVIDIA Control Panel** **5** (Figure 1 - 30).

OR

2. Double-click the icon **6** (Figure 1 - 30) in the **Windows** control panel.
3. See **"NVIDIA Video Driver Controls" on page C - 1** for full details on control panels etc.

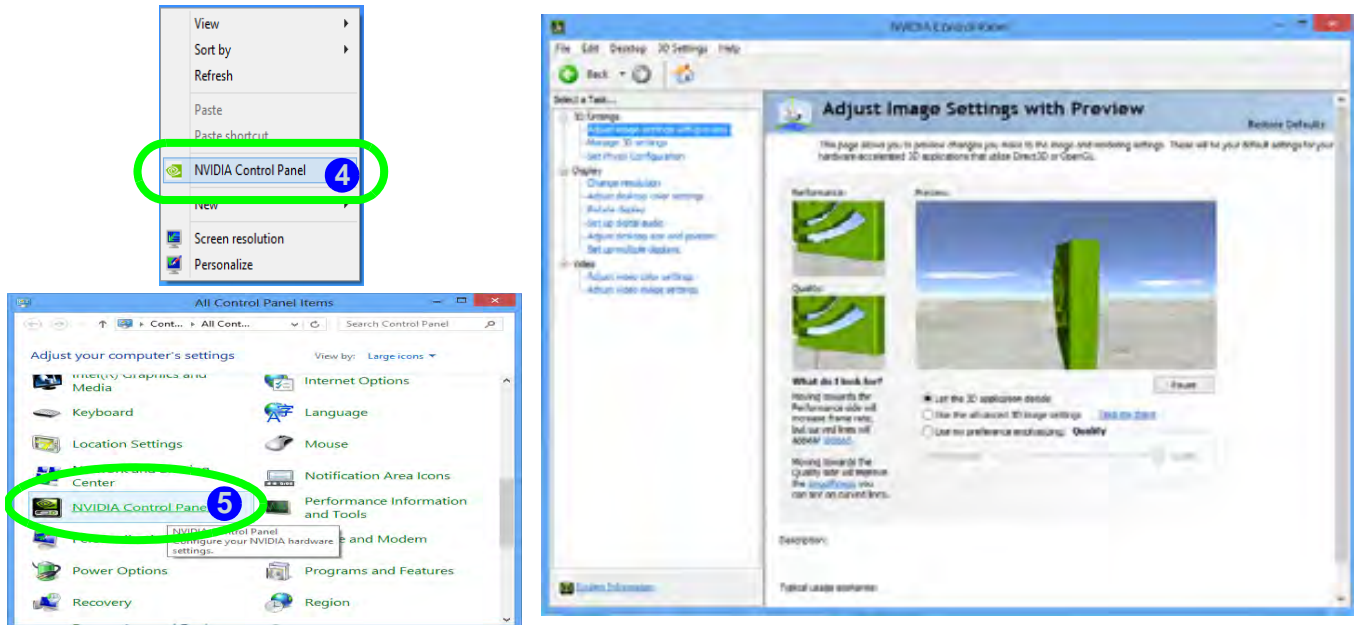



Figure 1 - 30 - NVIDIA Control Panel

Quick Start Guide

To access the **AMD Catalyst™ Control Center**:

1. Right-click the desktop and select  **Catalyst Control Center** (at the top of the desktop menu) **1** (*Figure 1 - 31*).
OR
2. Click **Advanced settings** in the **Screen Resolution** control panel (see *Figure 1 - 29*), click the **Catalyst Control Center** tab and then click **Catalyst Control Center** **2**.
3. Double-click (or right-click the icon and select **Graphics Properties**) the icon  in the **Windows** system tray notification area (make sure “**Enable System Tray Menu**” is clicked in **Preferences** **3**).
4. See “**AMD Video Driver Controls**” on page **D - 1** for full details on control panels etc.

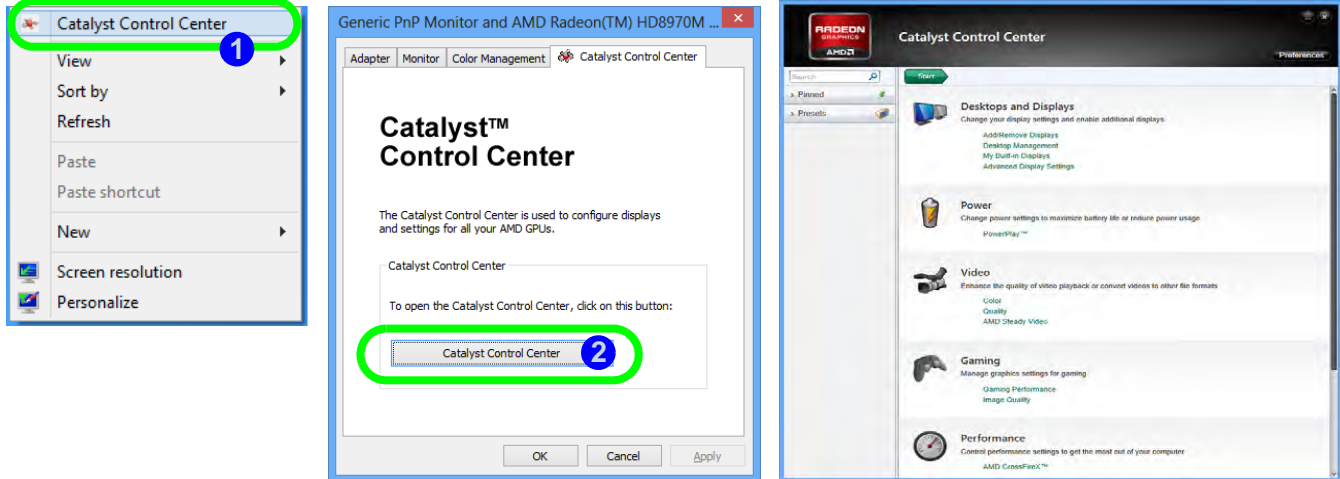

Figure 1 - 31 - Catalyst Control Center Access

Configuring External Displays

In *Windows 8* it is possible to quickly configure external displays from the **Devices** menu item in the **Charms Bar** (see “*Windows 8 Charms Bar*” on page 1 - 33).

To Configure External Displays from Devices (Charms Bar):

1. Attach your display to the appropriate port, and turn it on.
2. Go the **Charms Bar** and select **Devices**.
3. Click **Second Screen**.
4. Click on any one of the options from the menu to select Duplicate, Extend or a Single display.

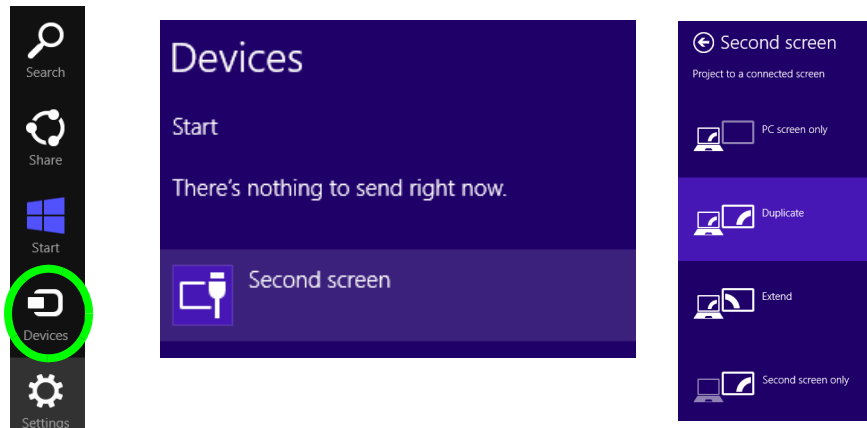

Figure 1 - 32 - Second Screen (Devices)

Power Options

Power Options (Hardware and Sound) can be accessed from the Control Panel. The **Power Menu** item in **Settings** in the **Charms Bar** in *Windows 8* may be used to **Shut down** or **Restart** (you can also add **Hibernate/Sleep** to the menu - see *“Adding Hibernate/Sleep to the Power Menu” on page 3 - 9*).

Shut Down, Restart or Sleep

1. Go to the **Charms Bar** and click **Settings**.
2. Click **Power** .
3. Select **Sleep**, **Shut Down** or **Restart**.

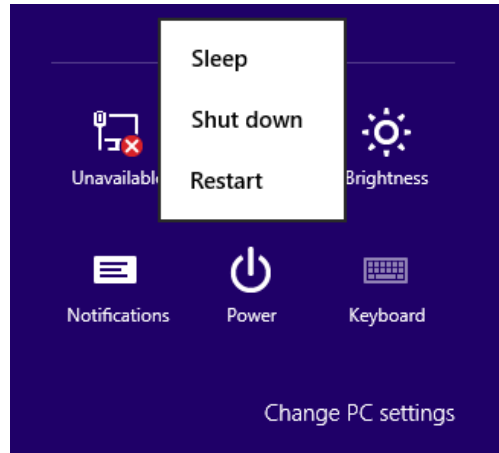

Figure 1 - 33 - Power (Settings)

Running Apps

To run apps in *Windows 8* you will need to check that the **Screen Resolution** and **User Account Control Settings** are compatible with the system requirements.

Screen Resolution Settings

1. Switch to the Windows Desktop (click the app or use the Windows logo key **+** **D** key combination).
2. Right-click a blank area of the Windows Desktop and select **Screen Resolution**. Adjust the **Resolution** to make sure that it is at least **1024 * 768**, although preferably **1366 * 768** or above (see sidebar).

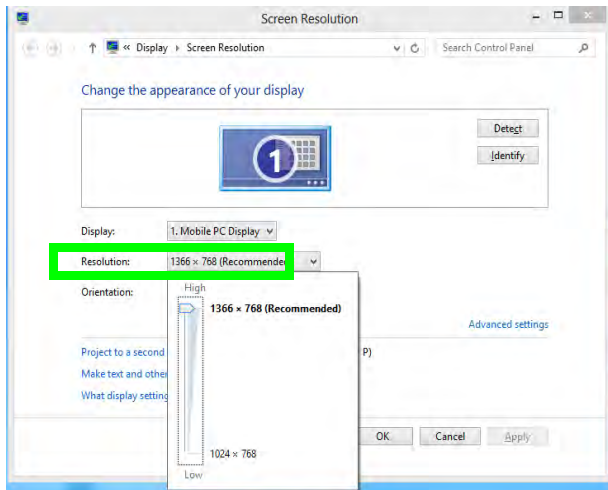

Screen Resolution for Metro Style Apps (Windows 8)

The minimum resolution in which Metro style Apps will run is **1024x768**.

The minimum resolution required to support all the features of Windows 8 (including multitasking with snap) is **1366x768**.

These specs are the minimum screen resolution that supports all the features of Windows 8 on a useful physical size.

Figure 1 - 34 - Screen Resolution

Quick Start Guide

User Account Control Settings

If your computer meets the minimum screen resolution requirements, and still you can't run Metro apps, then that you have to check the status of **User Account Control (UAC)**. Metro apps may fail to open when the UAC is turned off. To check whether the UAC is on or off, follow the instructions below.

1. Open the **Control Panel**.
2. Click on **User Accounts** and then click on **Change User Account Control settings** (or click **System and Security** and click **Change User Account Control Settings** under **Action Center**).
3. If the slider is in the **Never notify** position, then the UAC is disabled.
4. To enable or turn on the UAC, move the slider to **Always notify** or **Notify me when apps try to make changes to my computer (default)** position, and then click **OK**.

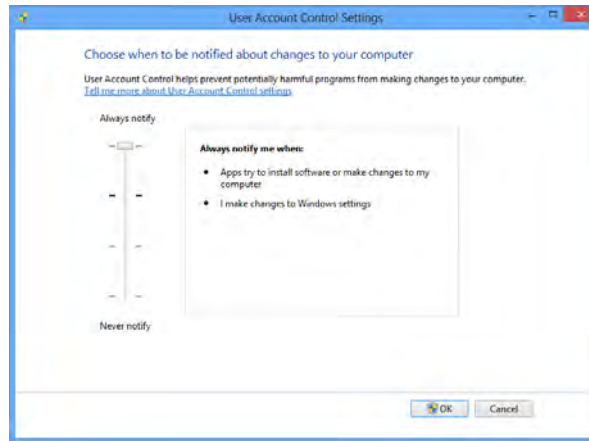

Figure 1 - 35 - User Account Control

Chapter 2: Storage Devices, Mouse & Audio

Overview

Read this chapter to learn more about the following main features and components of the computer:

- Hard Disk Drive
- Optical Device
- Multi-In-1 Card Reader
- Audio Features
- Clickpad/Touchpad and Buttons/Mouse



Warranty Warning

Please check with your distributor/supplier before undertaking any upgrade procedures to find out if this will VOID your warranty.

Power Safety

Before attempting to access any of the internal components of your computer please ensure that the machine is not connected to the AC power, and that the machine is turned off. Also ensure that all peripheral cables, including phone lines, are disconnected from the computer.

Figure 2 - 1
Hard Disk Bay

Hard Disk Drive

The hard disk drive(s) is(are) used to store your data in the computer. The hard disk(s) can be taken out to accommodate other 2.5" serial (SATA) hard disk drives with a height of 9.5 mm. The hard disk bay **1** is accessible from the bottom of your computer as seen below (note that only one model is pictured however the location of the HDD bay is identical for all models).

The computer can accommodate up to two hard disks and these may be configured in **RAID**, **AHCI** or **IDE** modes. Further details on removing and inserting the hard disk are available in *“Upgrading the Hard Disk Drive(s)” on page 6 - 8* and.

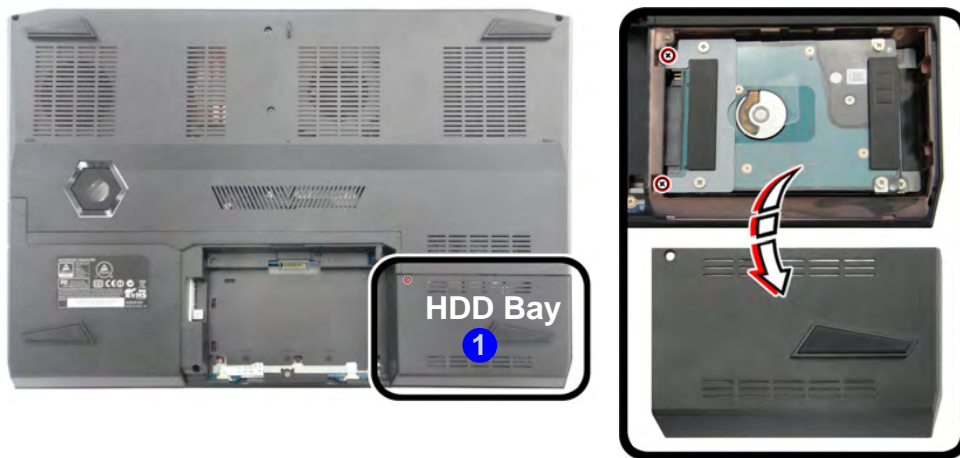

Optical Device

There is a bay for a 5.25" optical (CD/DVD) device (12.7mm height). The actual device will depend on the model you purchased (see *“Storage” on page E - 3*). The optical device is usually labeled **“Drive D:”** and may be used as a boot device if properly set in the **BIOS** (see *“Boot Menu” on page 5 - 17*).

Loading Discs

To insert a CD/DVD, press the open button **1** and carefully place a CD/DVD onto the disc tray with label-side facing up (use just enough force for the disc to click onto the tray’s spindle). Gently push the CD/DVD tray in until its lock “clicks” and you are ready to start. The busy indicator **2** will light up while data is being accessed, or while an audio/video CD, or DVD, is playing. If power is unexpectedly interrupted, insert an object such as a straightened paper clip into the emergency eject hole **3** to open the tray.

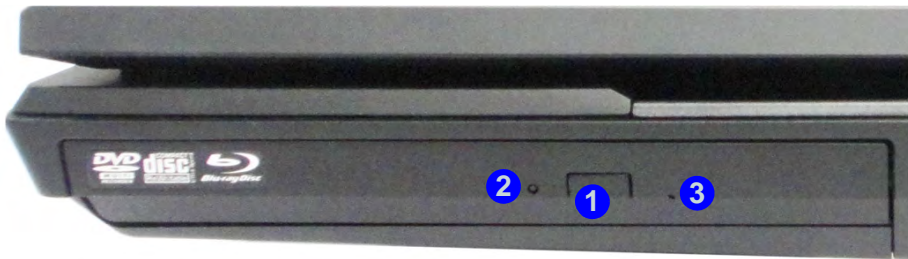

Figure 2 - 2
Optical Device



Sound Volume Adjustment

How high the sound volume can be set depends on the setting of the volume control within **Windows**. Click the **Volume** icon on the taskbar to check the setting.

Peripherals must be connected before you turn on the system.



CD Emergency Eject

If you need to manually eject a CD (e.g. due to an unexpected power interruption) you may push the end of a straightened paper clip into the emergency eject hole. However please do NOT use a sharpened pencil or similar object that may break and become lodged in the hole.

Disk Eject Warning

Don't try to remove a CD/DVD while the system is accessing it. This may cause the system to "crash".

Handling CDs or DVDs

Proper handling of your CDs/DVDs will prevent them from being damaged. Please follow the advice below to make sure that the data stored on your CDs/DVDs can be accessed.

Note the following:

- Hold the CD or DVD by the edges; do not touch the surface of the disc.
- Use a clean, soft, dry cloth to remove dust or fingerprints.
- Do not write on the surface with a pen.
- Do not attach paper or other materials to the surface of the disc.
- Do not store or place the CD or DVD in high-temperature areas.
- Do not use benzene, thinner, or other cleaners to clean the CD or DVD.
- Do not bend the CD or DVD.
- Do not drop or subject the CD or DVD to shock.

DVD Regional Codes

To change the DVD regional codes see *“Changing DVD Regional Codes”* on page 1 - 24.

| DVD Regional Coding | |
|---------------------|---|
| Region | Geographical Location |
| 1 | USA, Canada |
| 2 | Western Europe, Japan, South Africa, Middle East & Egypt |
| 3 | South-East Asia, Taiwan, South Korea, The Philippines, Indonesia, Hong Kong |
| 4 | South & Central America, Mexico, Australia, New Zealand |
| 5 | N Korea, Russia, Eastern Europe, India & Most of Africa |
| 6 | China |

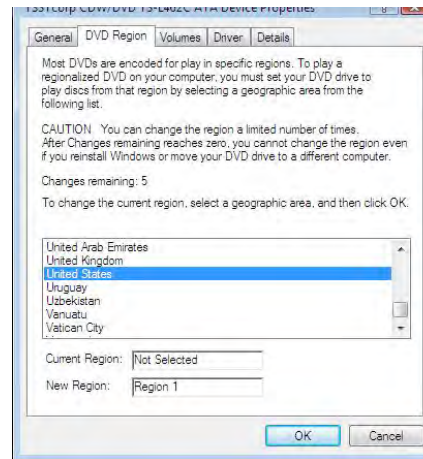

Table 2 - 1
DVD Regional Coding



Card Reader Cover

Make sure you keep the cover in the card reader when not in use. This will help prevent foreign objects and/or dust getting in to the card reader.

Push-Push Card Reader

The card reader features a push-in/push-out card insertion and ejection mechanism. Simply push the card to insert and eject it, however Ms Duo cards require an adapter.

Multi-In-1 Card Reader

The card reader allows you to use some of the latest digital storage cards. Push the card into the slot and it will appear as a removable device, and can be accessed in the same way as your hard disk (s). Make sure you install the Card Reader driver (see *“Card Reader” on page 4 - 7*).

- MMC (MultiMedia Card) / RSMHC
- SD (Secure Digital) / Mini SD / SDHC / SDXC
- MS (Memory Stick) / MS Pro / MS Duo



PC adapters may be required for some of these cards and are usually supplied with them.



Figure 2 - 3
Left View

1. Card Reader

Audio Features

You can configure the audio options on your computer from the **Sound**  control panel in *Windows*, or from the **Realtek HD Audio Manager**  icon in the notification area/control panel (right-click the taskbar notification area icon  to bring up an audio menu). The volume may also be adjusted by means of the **Fn + F5/F6** key combination (see *Table 1 - 6, on page 1 - 19*).



Right-click the icon  to access the menu above.

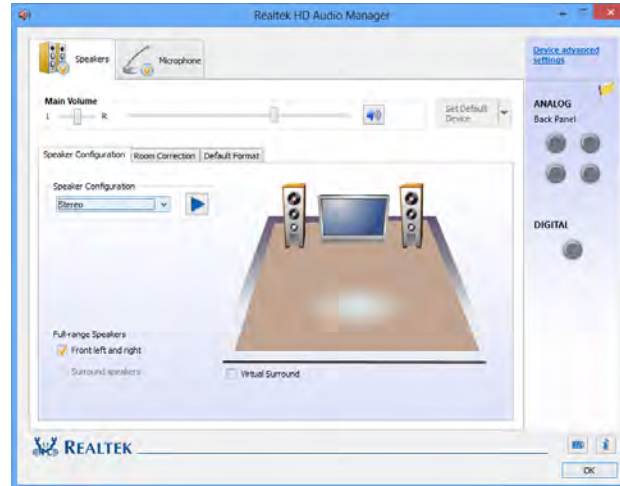

See *“HDMI Audio Configuration” on page C - 17* for a description of the audio configuration when connecting an HDMI supported display device. See also *“Sound Blaster Audio” on page 7 - 77*.



Volume Adjustment

The sound volume level is set using the volume control within *Windows* (and the volume function keys on the computer). Click the volume icon in the notification area to check the setting.

Headphone Configuration

It is recommended that you set the **Speaker Configuration** to **Stereo** (not to 5.1 or 7.1 Speaker) when listening through headphones in order to maximize audio quality.

Figure 2 - 4
Realtek Audio Manager

Setup for 5.1 or 7.1 Surround Sound

To setup your system for 5.1 or 7.1 surround sound you will need to connect the audio cables to the Headphone-Out, Line-In, Microphone-In jack and S/PDIF-Out jacks (*note: the S/PDIF jack is used for 7.1 surround sound only*).

1. Click **Start**, and click **Control Panel** (or point to **Settings** and click **Control Panel**) and make sure you are in **Classic View**.
2. Click **Realtek HD Audio Manager** (or right-click the notification area icon  and select **Sound Manager**).
3. Click **Speakers** (tab) and click **Speaker Configuration** (tab).
4. Select **5.1 or 7.1 Speaker** from the **Speaker Configuration** pull-down menu.

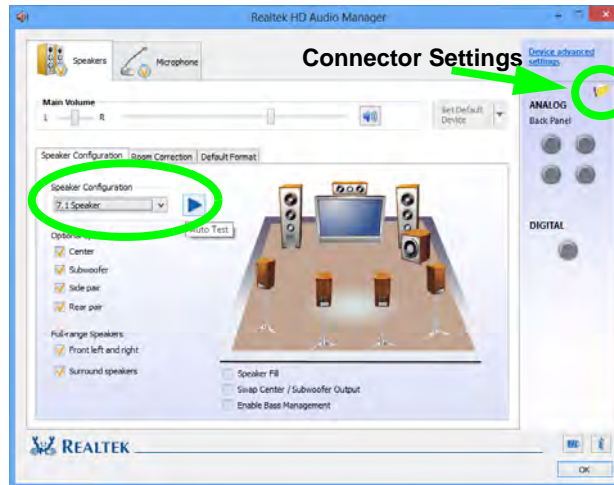



Figure 2 - 5
Speaker
Configuration (7.1)

Auto Popup Dialog

You should enable the auto popup dialog to automatically detect when a device has been plugged-in. If disabled, double-click **connector settings**  and click the box to enable the auto popup detection of plugged-n devices.

5. Plug the **front speaker** cables into the **Headphone-Out Jack**.
6. Plug in the other cables (you may require an adapter to connect each cable to the appropriate jack e.g a stereo mini to dual RCA adapter) from your speakers as follows:
 - Line-In Jack = Rear Speaker Out
 - Microphone-In Jack = Center/Subwoofer Speaker Out
 - S/PDIF-Out Jack = Side Speaker Out (**for 7.1 Surround Sound Only**)
7. As you plug in each cable a dialog box will pop up.
8. Click to put a tick in the appropriate box according to the speaker plugged-in (e.g. Rear Speaker Out), and then click **OK** to save the setting.
9. Click **OK** to exit **Realtek HD Audio Manager**.

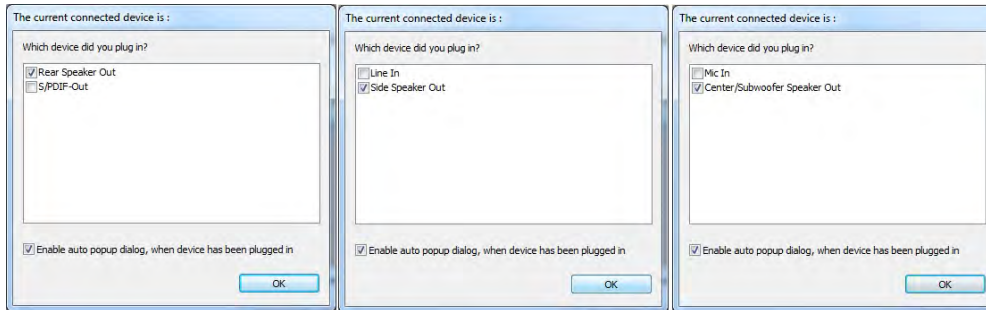



Figure 2 - 6
**Connected Device
Auto Popup**

Note: Side Speaker Out is required for 7.1 Surround only.

Setup for Audio Recording

To record audio sources on your computer at optimum quality follow the instructions below:

1. Click **Control Panel** and make sure you are in **Classic View**.
2. Click **Realtek HD Audio Manager** (or right-click the notification area icon  and select **Sound Manager**).
3. Click **Microphone Effects** (tab) in **Microphone** (tab), and then click to select **Noise Suppression** (button), or adjust the **Recording Volume** level to around **60**, to obtain the optimum recording quality.
4. Click **OK** to close the control panel and save the settings.

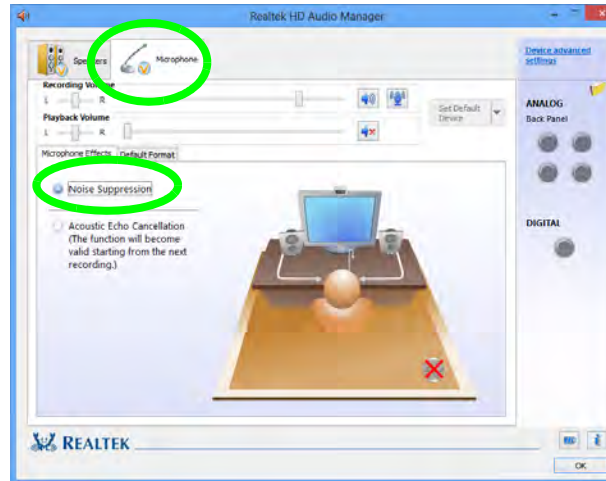

Figure 2 - 7
**Realtek Audio
Manager -
Recording Setup**

Clickpad/Touchpad and Buttons/Mouse

The Clickpad/Touchpad is an alternative to the mouse; however, you can also add a mouse to your computer through one of the USB ports. The Clickpad/Touchpad buttons function in much the same way as a two-button mouse.

The Touchpad driver installed on your system will be dependent on your computer model. See overleaf for Clickpad/Touchpad sensitivity information, and see the pages indicated below for configuration information.

- See pages [2 - 12](#) to [2 - 19](#) for Clickpad/Touchpad information for **Models A & C**.
- See pages [2 - 20](#) to [2 - 29](#) for Clickpad/Touchpad information for **Model B**.



Clickpad Cleaning

In order to improve pad performance it is necessary to keep the surface clean and free of fingerprints and marks etc.

Use the cleaning cloth supplied to keep the pad surface clean.

Disabling Clickpad

Use the **Fn + F1** or Control Center button to disable the Clickpad/Touchpad.

Figure 2 - 8
**Clickpad/Touchpad
Sensitivity**

Clickpad/Touchpad Sensitivity

The mouse button zones at the bottom of the pad measure about 15mm from the bottom of the pad, and the left and right buttons are divided roughly down the middle as illustrated below. Press the left button zone for a left click, and right button zone for a right click action.

Illuminated Touchpad Sensitivity

Note that the illuminated Touchpad (**Model B**) has a defined valid operational area of sensitivity indicated within the **sensor area** of the illustration below:

- **4 mm** from the top/bottom of the touchpad edges, and **5 mm** from the left/right sides of the touchpad.

Figure 2 - 9
Clickpad/Touchpad
Sensitivity

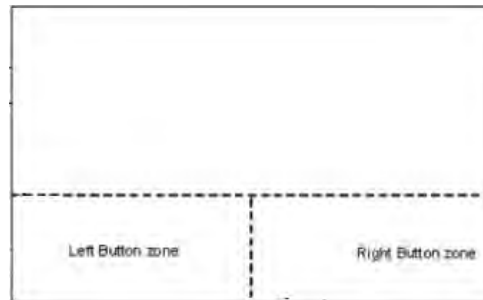

Illuminated Touchpad for Model B Computers

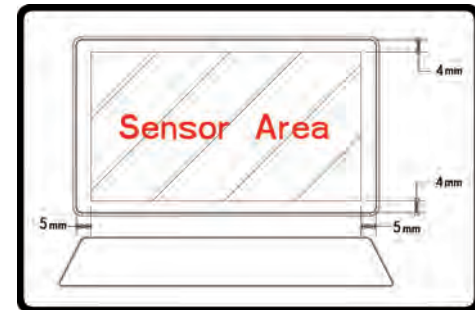

Touchpad Configuration for Models A & C

Once you have installed the Touchpad driver (see *“Touchpad (Clickpad)” on page 4 - 7*) you can configure the functions from the Mouse control panel in **Windows**, or by double-clicking the Touchpad driver icon  in the notification area of the taskbar in the Desktop app. You may then configure the tapping, buttons, scrolling, pointer motion and sensitivity options to your preferences. Use the **Fn + F1** key combination to toggle the Clickpad/Touchpad on/off.



Mouse Driver

If you are using an external mouse your operating system may be able to auto-configure your mouse during its installation or only enable its basic functions. Be sure to check the device's user documentation for details.

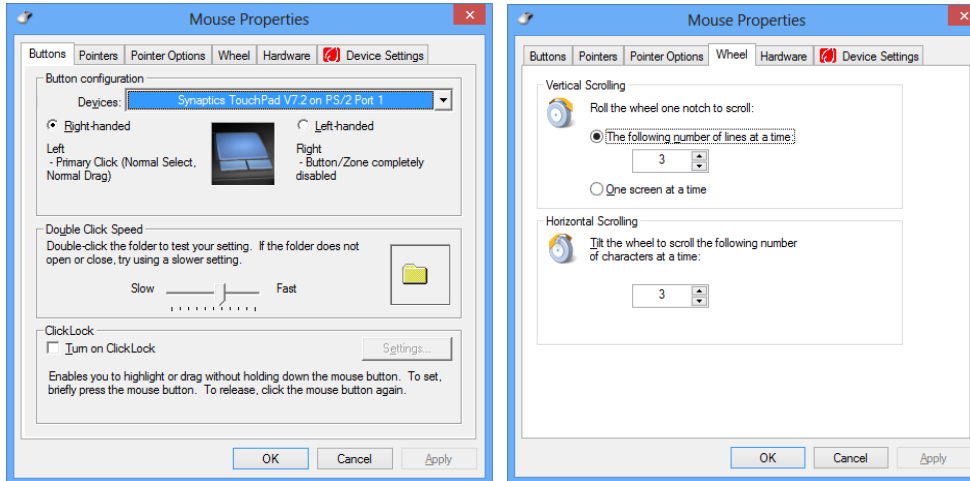

Figure 2 - 10
Mouse Properties



Show Video

You can get a clearer view of the gestures involved by clicking the **Show Video** option for each gesture item.

Select the gesture (**Pinch Zoom**, **Rotating**, **Three Fingers Down** and **Three Finger Flick**) in the **Device Settings > Settings** left tree menu and click the **Show Video** button to see the demonstration video.

For more details on any of the gestures see the text in the lower part of the right menu window.

Figure 2 - 11
Mouse Properties - Device Settings

Gestures and Device Settings

The Synaptics Gestures Suite application allows you to use a specific gesture (action) on the surface of the Clickpad/Touchpad to perform specific actions to manipulate documents, objects and applications.

You can configure the settings from the Device Settings tab in **Mouse Properties**:

1. Go to the **Control Panel**.
2. Click **Mouse (Hardware and Sound)**.
3. Click **Device Settings** (tab) and click **Settings**.
4. Use the menu tree on the left to access the user configurable settings.

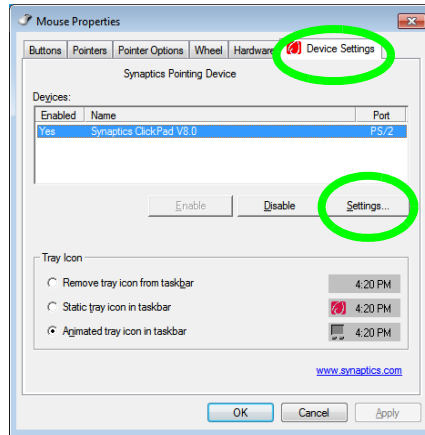

Disabling the Touchpad

If you need to disable the Touchpad for any reason (e.g. you may find that when using the computer's internal keyboard you accidentally trigger the Touchpad when resting your wrists or palms on it) you can do so by using **Fn + F1** key combination.

You can also set the system to automatically disable the internal Touchpad when an external USB point device (e.g a USB mouse) is attached.

1. Go to the **Mouse Properties** control panel.
2. Click to select **Device Settings** (tab).
3. Click to place a tick in the "**Disable internal pointing device when external USB pointing device is attached**" tickbox.
4. Click **OK** to save the setting.

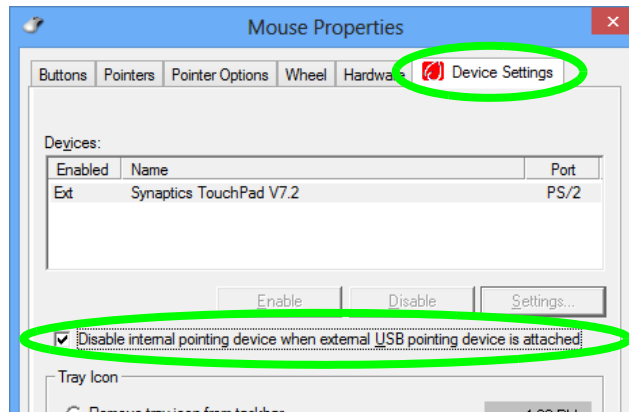

Figure 2 - 12
Mouse Properties
(Disable Touchpad)



PalmCheck

In order to improve Clickpad/Touchpad scrolling responsiveness when using one-finger scrolling, you can adjust the PalmCheck slider towards “Minimum” as per your preference.

However bear in mind that adjusting the slider too far towards “Minimum” can turn off PalmCheck altogether.

PalmCheck

The PalmCheck feature helps prevent operating the Clickpad/Touchpad by accident, by recognizing when your palm is resting on it or brushing its surface while you are typing.

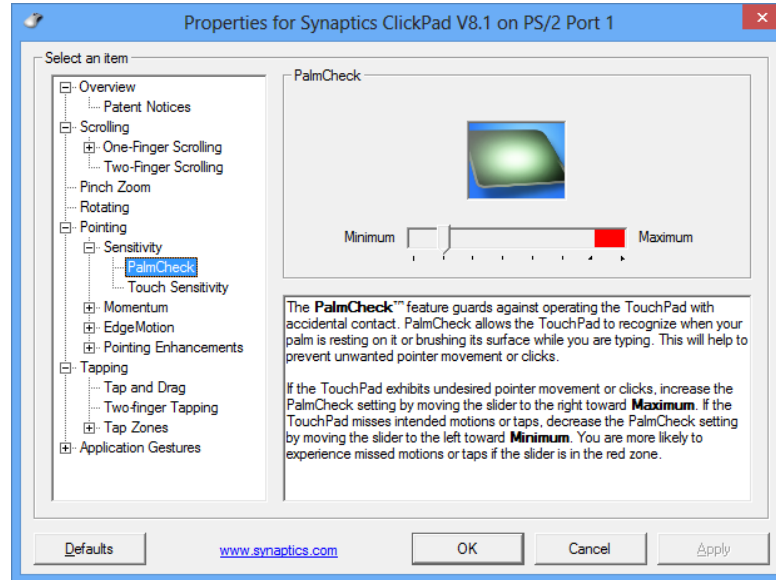



Figure 2 - 13
PalmCheck Slider

Tap to Click

Enable/disable the **Tap to Click** feature from the icon in the notification area of the taskbar. Right-click the Touchpad driver icon  in the notification area of the **taskbar** and click **Tap to Click** to enable or disable the feature. When enabled you can use a single-tap with your finger to signify a single left mouse click, and a double-tap signifies a double left mouse click.

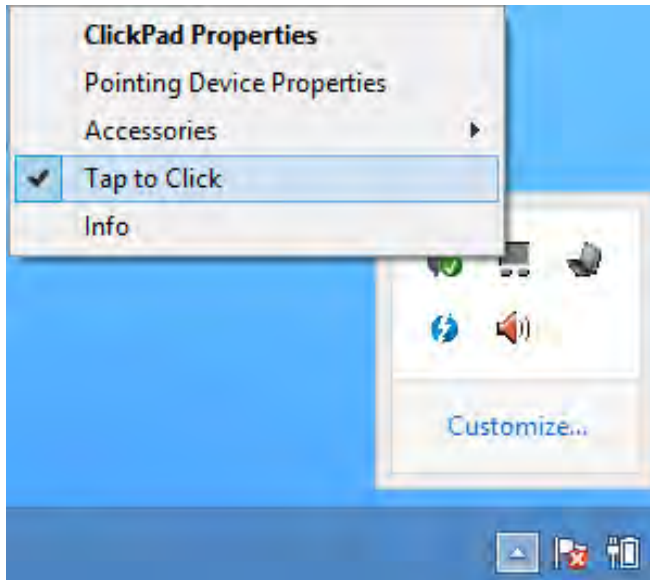

Figure 2 - 14
Tap to Click
(Enabled)



Show Video

See [“Show Video” on page 2 - 14](#) for help on gestures.

For more details on any of the gestures, select a gesture and see the text in the lower part of the right menu window.

Scrolling

One-Finger scrolling allows you to scroll vertically by sliding your finger upwards/downwards along the right edge of the Clickpad/Touchpad, or horizontally by sliding your finger left/right along the lower edge of the pad.

The Two-Finger scrolling feature works in most scrollable windows and allows you to scroll horizontally and vertically from anywhere on the pad surface. Place two fingers, slightly separated, on the pad surface and slide both fingers in the direction required (in a straight continuous motion).



Figure 2 - 15

Two-Finger Scrolling Gesture

Zooming

The Pinch Zoom gesture can be used to perform the same function as a scroll wheel in *Windows* applications that support CTRL + scroll wheel zoom functionality. Place two fingers on the pad (for best results use the tips of the fingers) and slide them apart to zoom in, or closer together to zoom out.



Figure 2 - 16

Zooming Gesture

Rotating

Use the Twist Rotate gesture to rotate objects (e.g. photos). Select the object to rotate and place two fingers down on the pad with a slight gap between them. Slide both fingers clockwise or counterclockwise (similar to the motion of turning a knob) to rotate the object.



Figure 2 - 17
Rotating Gesture

Three Finger-Flick/Three Fingers Down (Press)

The Three Finger-Flick gesture may be used to enhance navigation with a variety of applications such as browsing the Internet or scrolling through a photo viewer. The Three Fingers Down gesture may be used to launch user-selectable applications.

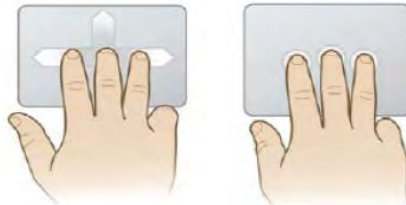



Figure 2 - 18
Flick/Press
Gesture



Tray Icon

Make sure that the Touchpad driver icon  in the notification area of the **Desktop** taskbar.

Go to the control panel (**Mouse** control panel in **Windows**), click **Finger Sensing Pad** (tab), click **Tray Icon** and then make sure **Show Tray Icon** is clicked.

Figure 2 - 19
Mouse Properties

Touchpad Configuration for Model B

Once you have installed the Touchpad driver (see *“Touchpad (Clickpad)” on page 4 - 7*) you can configure the functions by double-clicking the Touchpad driver icon  in the notification area of the **Desktop** taskbar, or from the **Mouse** control panel in **Windows**. You may then configure the Touchpad tapping, buttons, scrolling (see sidebar), pointer motion and sensitivity options to your preferences.

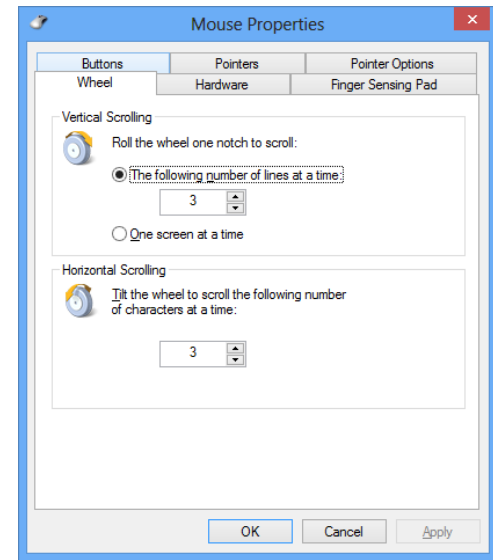
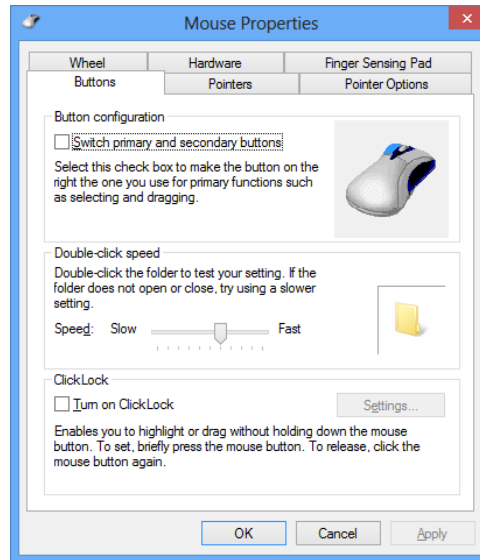

Finger Sensing Pad Configurator

The **Finger Sensing Pad Configurator** allows you to use a configure the settings for the Finger Sensing Pad device and software. The left pane in the control panel contains all the configurable items, and you can click the “+” to expand the menu selections.

1. Go to the **Control Panel**.
2. Click **Mouse (Hardware and Sound)**.
3. Click **Finger Sensing Pad** (tab) and click **Configure**.
4. Use the menu tree on the left to access the user configurable settings.

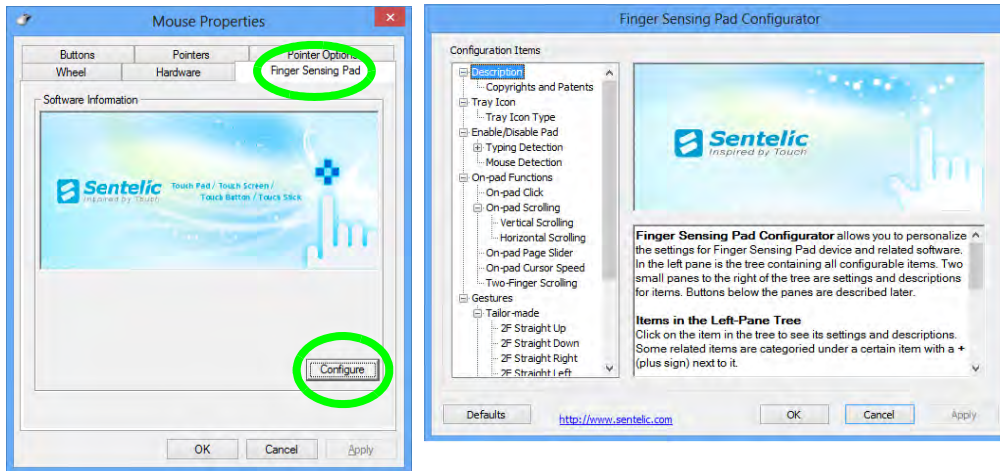

Configuration

Click **Defaults** to re-store all the factory settings.

Press **OK** to save the changes and close the configurator.

Click **Apply** to save changes but remain in the configurator.

Figure 2 - 20
Finger Sensing Pad Configurator

Disabling the Touchpad

If you need to disable the Touchpad for any reason (e.g. you may find that when using the computer's internal keyboard you accidentally trigger the Touchpad when resting your wrists or palms on it) you can do so by using **Fn + F1** key combination.

You can also set the system to automatically disable the internal Touchpad when an external USB pointing device (e.g. a USB mouse) is attached, or while you are typing (see over).

1. Go to the **Mouse** control panel and click to select **Finger Sensing Pad** (tab).
2. Click to place a tick in the "**Disable pad while external mouse is plugged in**" box.
3. Click **OK** to save the setting.

Figure 2 - 21
Mouse Detection

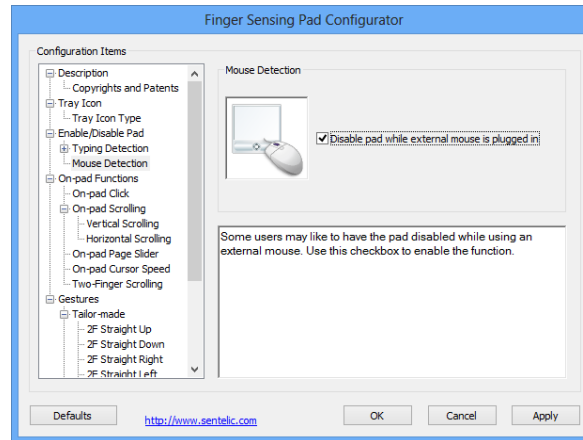

You can also enable **Typing Detection** to disable the pad while you are typing. The pad will be disabled while typing is detected, and will be reactivated after a set interval of time when typing is not detected. You can use the slider to adjust the reactivation time for an appropriate interval.

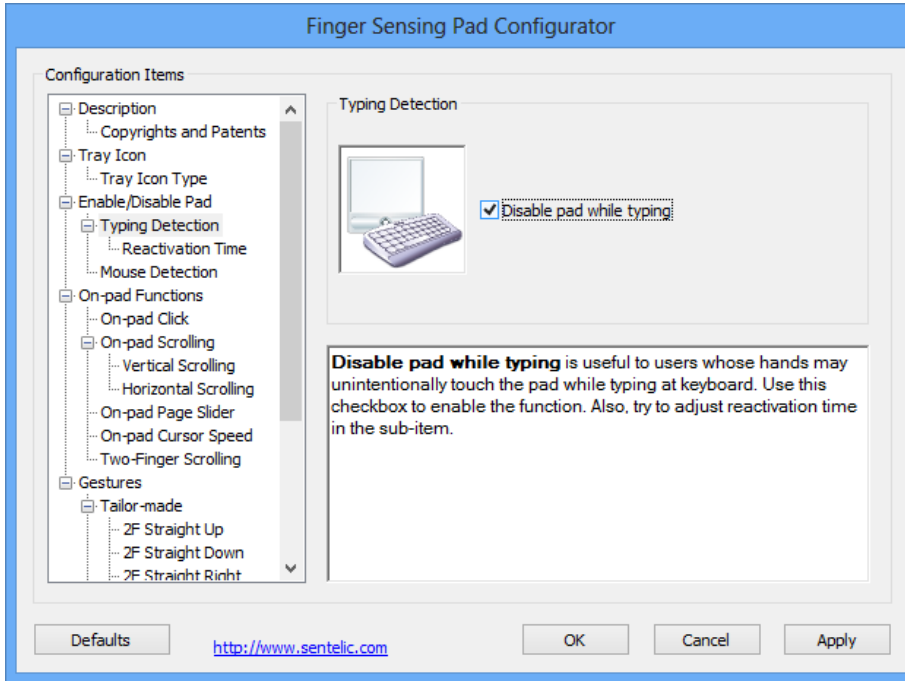

Figure 2 - 22
Disable Pad While
Typing



Traditional or Reverse Scrolling

With **traditional scrolling**, when you want to scroll up a web page, you put fingers on the pad and them move upwards. When you want to scroll down, you move your fingers down.

Reverse scrolling reverses the process; to make a webpage scroll down, you have to move fingers up on the pad, and to scroll up you move your fingers down.

Figure 2 - 23
Enable Reverse Scrolling Direction

On-pad Functions

Put a tick in the appropriate box to enable the function.

- **On-pad Click** - The same function as a left mouse click.
- **Vertical/Horizontal Scrolling** - This will enable sensing zones on the pad to allow you to touch to enable scrolling.
- **On-pad Click Page Slider** - This will enable sensing zones on the pad to allow you to touch to enable sliding up and down the pad.
- **On-pad Cursor Speed** - Use the slider to adjust the pad pointer speed.
- **Two Finger Scrolling** - You can enable/disable **reverse** two-finger scrolling (see below) from this item.

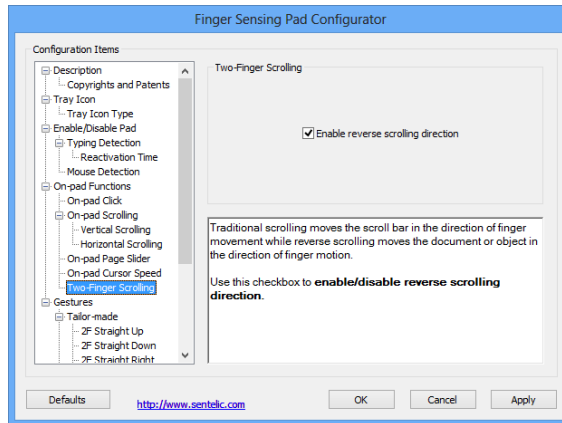

Gestures

Click **Gestures** and make sure that the **Enable Gestures** tickbox is clicked. Double-click **Gestures** and then double-click **Tailor-made or Applications** to open the sub-menu. You can enable/disable and configure any of the **Tailor-made** gestures from these submenus.

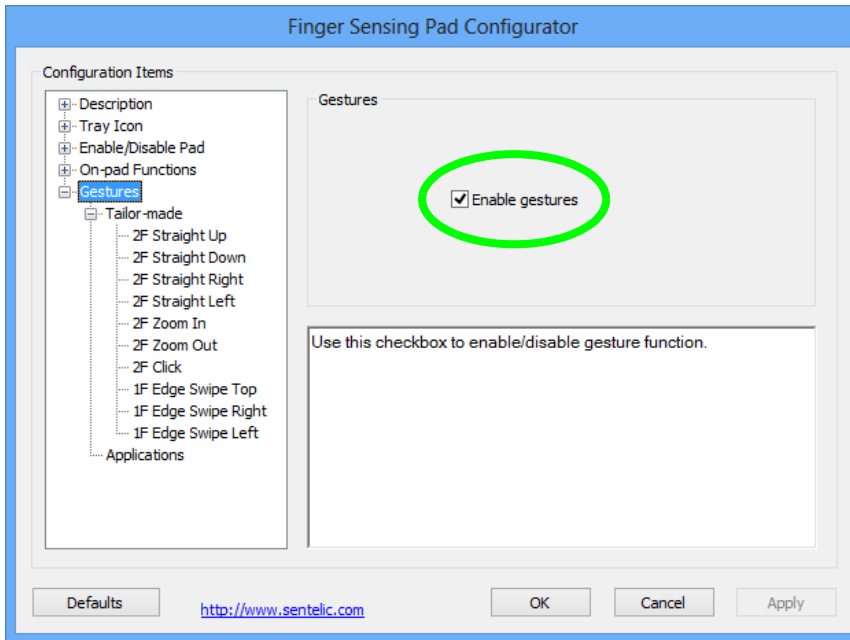

Play Video

You can get a clearer view of the gestures involved by clicking the **Play Video** option for each gesture item.

Figure 2 - 24
Finger Sensing Pad - Gestures

- **Two Fingers Straight Up/Down** - Place two fingers side by side on the pad, slightly apart. Slide the fingers upwards/downwards in a continuous motion.

Figure 2 - 25
**2F Straight Up/
Down**



- **Two Fingers Straight Right/Left** - Place two fingers side by side on the pad, slightly apart. Slide the fingers right/left in a continuous motion.

Figure 2 - 26
**2F Straight Right/
Left**



- **Two Fingers Zoom In/Out** - Place two fingers side by side on the pad, slightly apart. Slide the fingers apart in a continuous motion to zoom in, or slide the fingers closer together to zoom out.

Figure 2 - 27
2F Zoom In/Out



- **Two Fingers Click** - Tap the pad with two slightly separated fingers. This simulates the use of a middle mouse button often used in the most common internet browsers.



Figure 2 - 28
2F Click

- **One Finger Edge Swipe Top** - Place a single finger on the top edge of the pad and slide the finger downwards onto the pad. This is used to open the **App** bar in the **Windows Start menu** (not the desktop).



Figure 2 - 29
1F Edge Swipe Top

- **One Finger Edge Swipe Right** - Place a single finger on the right edge of the pad and slide the finger to the left onto the pad. This is used to open the **Charms** bar.

Figure 2 - 30
**1F Edge Swipe
Right**



- **One Finger Edge Swipe Left** - Place a single finger on the left edge of the pad and slide the finger to the right onto the pad. This is used to switch to the last used application.

Figure 2 - 31
1F Edge Swipe Left



Applications

A number of programs/applications support gestures which trigger functions within the program. The **Program List** displays the programs/applications supporting these functions, and you can use the scroll bar to the right to scroll up/down the list. Click to select the program/application and click **View** (or just double-click) to see the gestures supported.

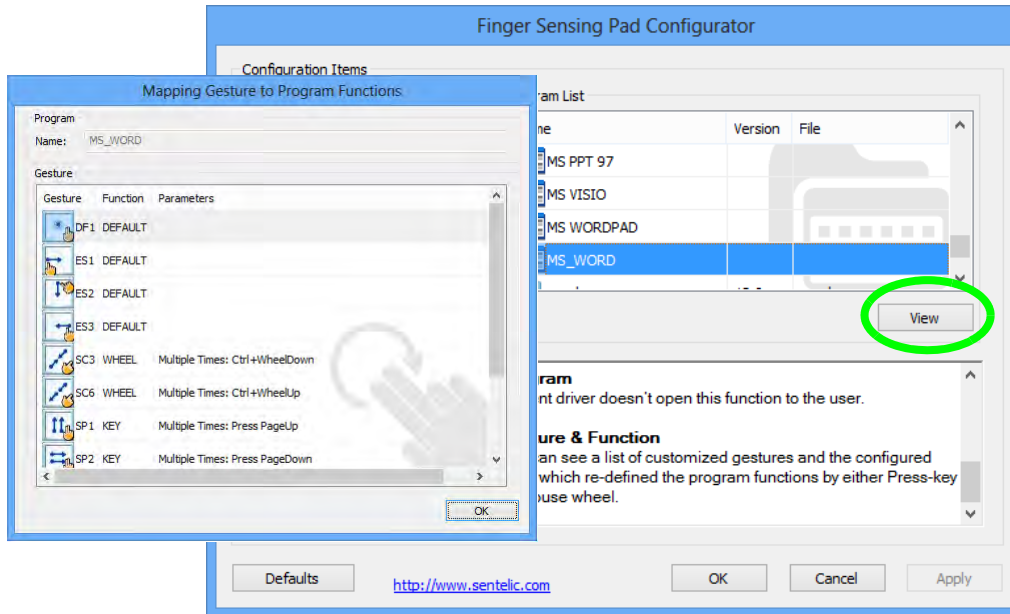

Figure 2 - 32
Applications

Chapter 3: Power Management

Overview

To conserve power, especially when using the battery, your computer power management conserves power by controlling individual components of the computer (the monitor and hard disk drive) or the whole system. This chapter covers:

- The Power Sources
- Turning On the Computer
- Power Plans
- Power-Saving States
- Configuring the Power Buttons
- Battery Information

The computer uses enhanced power saving techniques to give the operating system (OS) direct control over the power and thermal states of devices and processors. For example, this enables the OS to set devices into low-power states based on user settings and information from applications.



OS Note

Power management functions will vary slightly depending on your operating system. For more information it is best to refer to the user's manual of your operating system.



Forced Off

If the system “hangs”, and the **Ctrl + Alt + Del** key combination doesn’t work, press the power button for **4 seconds**, or longer, to force the system to turn itself off.

The Power Sources

The computer can be powered by either an AC/DC adapter or a battery pack.

AC/DC Adapter

Use only the AC/DC adapter that comes with your computer. The wrong type of AC/DC adapter will damage the computer and its components.

1. Attach the AC/DC adapter to the DC-in jack at the rear of the computer.
2. Plug the AC power cord into an outlet, and then connect the AC power cord to the AC/DC adapter.
3. Raise the lid/LCD to a comfortable viewing angle.
4. Press the power button to turn “On”.

Battery

The battery allows you to use your computer while you are on the road or when an electrical outlet is unavailable. Battery life varies depending on the applications and the configuration you're using. **To increase battery life, let the battery discharge completely before recharging** (see *“Battery FAQ” on page 3 - 17*).

We recommend that you do not remove the battery. For more information on the battery, please refer to *“Battery Information” on page 3 - 13*.

Turning On the Computer

Now you are ready to begin using your computer. To turn it on simply press the power button on the front panel.

When the computer is on, you can use the power button as a Stand by/Hibernate/Shutdown hot-key button when it is pressed for less than **4 seconds** (pressing and holding the power button for longer than this will shut the computer down). Use **Power Options (Hardware and Sound)** in the *Windows* control panel to configure this feature.

3



Shut Down

Note that you should always shut your computer down by choosing the **Shut Down** command from the **Power Menu** in the **Settings** menu in the *Windows 8 Charms Bar*.

This will help prevent hard disk or system problems. If you want to add **Hibernate/Sleep** to the **Power Menu** see *“Adding Hibernate/Sleep to the Power Menu” on page 3 - 9.*

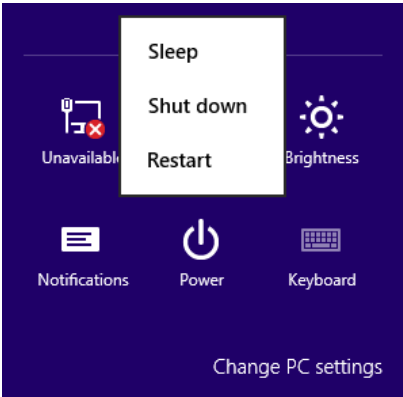



Power Button as Stand by or Hibernate Button

You can use the OS's "Power Options" control panel to set the power button to send the system into Stand by or Hibernate mode (see your OS's documentation, or *“Configuring the Power Buttons” on page 3 - 8* for details).

Figure 3 - 1
Power Menu
(Settings - Charms Bar)

Resuming Operation

See [Table 3 - 1](#), on [page 3 - 10](#) for information on how to resume from a power-saving state.

Password

It is recommended that you enable a password on system resume in order to protect your data.

Figure 3 - 2
Power Plan Advanced Settings

Power Plans

The computer can be configured to conserve power by means of **power plans**. You can use (or modify) an existing **power plan**, or create a new one.

The settings may be adjusted to set the **display** to turn off after a specified time, and to send the computer into **Sleep** after a period of inactivity.

Click *Change plan settings* and then click *Change advanced power settings* to access further configuration options in **Advanced Settings**.

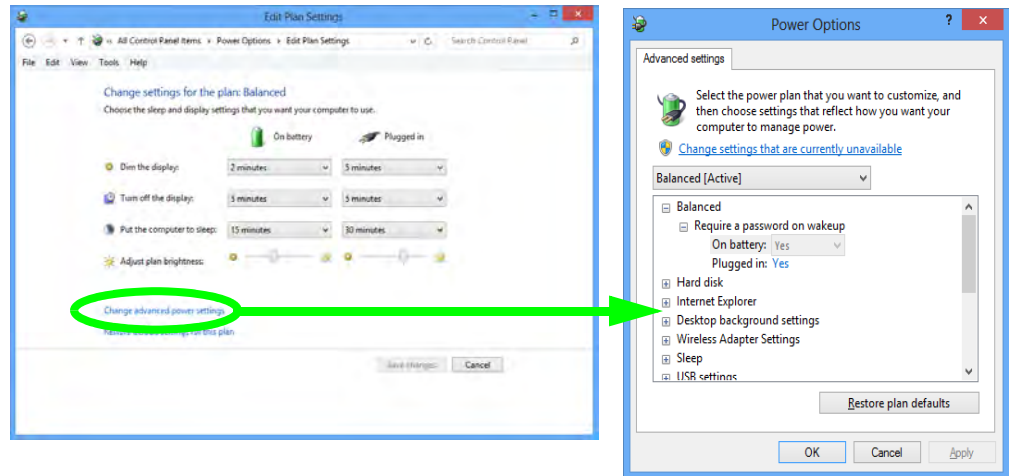

Each **Windows power plan** will also adjust the processor performance of your machine in order to save power. This is worth bearing in mind if you are experiencing any reduced performance (especially under DC/battery power).

Choose **High performance** (you may need to click **Show additional plans** to view the High performance plan) for maximum performance when the computer is powered from an AC power source. Choose the **Power saver** (bear in mind that this scheme may slow down the overall performance of the computer in order to save power) for maximum power saving when the computer is battery (DC power) powered.

Click to Show/Hide additional power plans

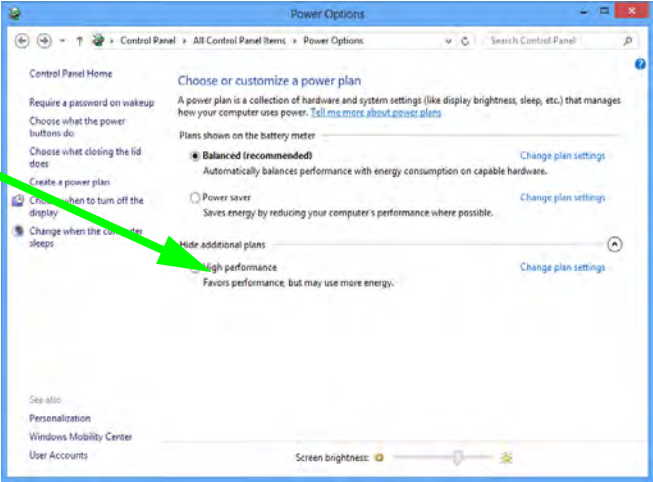
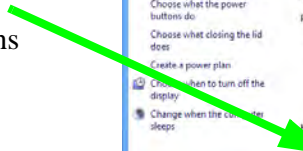

Figure 3 - 3 Power Plans



Wake On LAN Support (Windows 8)

Wake-On-LAN is only supported from **Sleep** or **Hibernate** states in *Windows 8*.

If you require your computer to wake up from network activity in *Windows 8* then make sure that the computer is either in **Sleep** or **Hibernate**.

Wake-On-LAN is not supported from Shut-down states in *Windows 8*.

Power-Saving States

You can use power-saving states to stop the computer's operation and restart where you left off. *Win 8* uses the **Sleep**, **Hibernate** and **Shut Down** power-saving states.

Sleep

In **Sleep** all of your work, settings and preferences are saved to memory before the system sleeps. When you are not using your computer for a certain length of time, which you specify in the operating system, it will enter **Sleep** to save power.

The PC wakes from **Sleep within seconds** and will return you to where you last left off (what was on your desktop) without reopening the application(s) and file(s) you last used.

If your mobile PC in **Sleep** is running on battery power the system will use only a minimum amount of power. After an extended period the system will save all the information to the hard disk and shut the computer down before the battery becomes depleted.

To add **Sleep** to the **Power Menu** see *“Adding Hibernate/Sleep to the Power Menu” on page 3 - 9*.

Hibernate

Hibernate uses the least amount of power of all the power-saving states and saves all of your information on a part of the hard disk before it turns the system off. If a power failure occurs the system can restore your work from the hard disk; if a power failure occurs when work is saved only to memory, then the work will be lost. **Hibernate** will also return you to where you last left off within seconds. You should put your mobile PC into **Hibernate** if you will not use the computer for a period of time, and will not have the chance to charge the battery. To add **Hibernate** to the **Power Menu** see *“Adding Hibernate/Sleep to the Power Menu” on page 3 - 9.*

Shut down

You should **Shut down** the computer if you plan to install new hardware (don't forget to remove the battery and follow all the safety instructions in **Chapter 6**), plan to be away from the computer for several days, or you do not need it to wake up and run a scheduled task. Returning to full operation from **Shut down** takes longer than from **Sleep** or **Hibernate**.

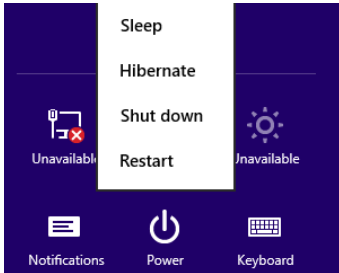

Figure 3 - 4
Power Menu



Password Protection

It is recommended that you enable a password on wake up in order to protect your data.

However you can disable this setting from the **Power Options** menu by clicking **Require a password on wakeup** in the left menu, and selecting the options (click **Change settings that are currently unavailable**).

Figure 3 - 5
Power Options
Define Power Buttons

Configuring the Power Buttons

The power/sleep button (**Fn + F4** key combo) and closed lid may be set to send the computer in to a power-saving state. Click **Choose what the power buttons do** on the left menu in **Power Options** to bring up the menu.

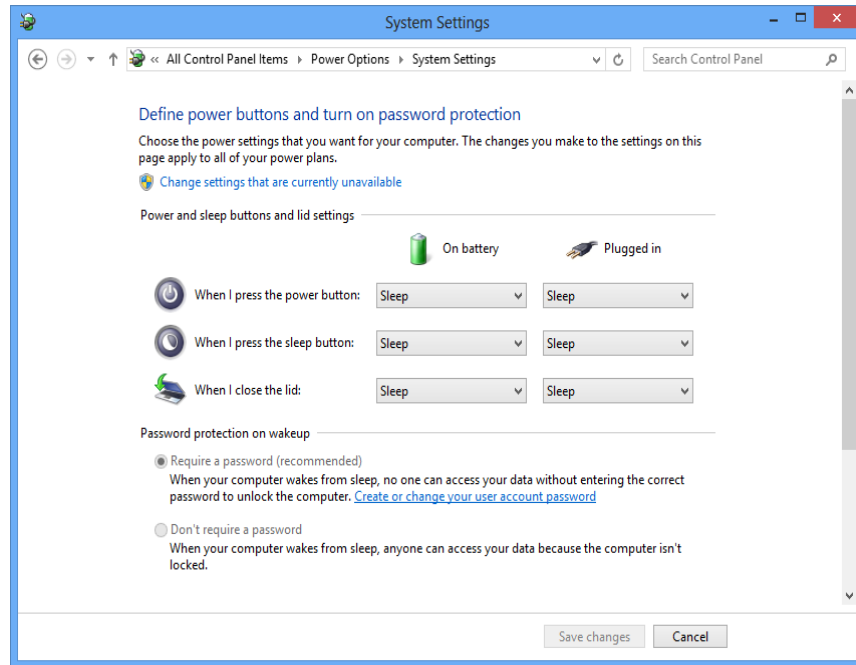

Adding Hibernate/Sleep to the Power Menu

Add **Hibernate/Sleep** to the **Power Menu** as follows.

1. Go to the **Power Options (Hardware and Sound)** control panel (see page **1 - 23**).
2. Click **“Change settings that are currently unavailable”**  [Change settings that are currently unavailable](#) .
3. Click **Choose what the power buttons do**.
4. Click to put a tick in the **Hibernate/Sleep** box under **Shutdown settings**.
5. Click **Save Changes** and close the control panel.

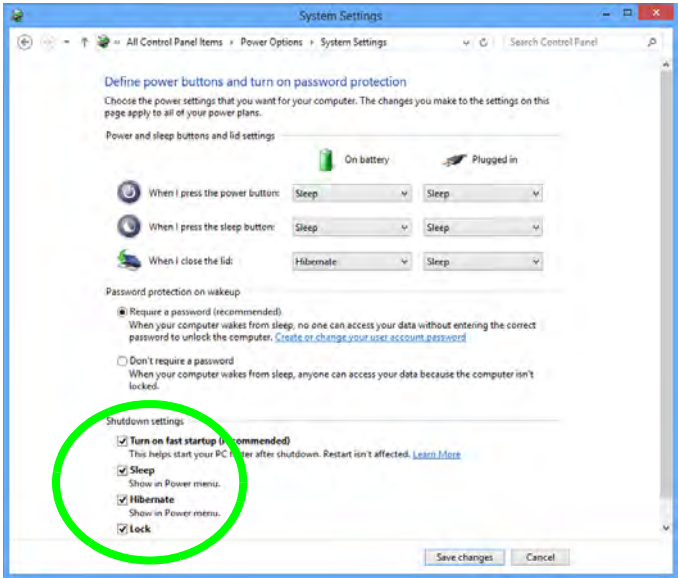



Figure 3 - 6
Power Options
Define Power
Buttons - Shutdown
Settings

Table 3 - 1
Resuming Operation

Resuming Operation

You can resume operation from power-saving states by pressing the power button, or in some cases pressing the sleep button (**Fn + F4** key combo).

| Power Status | Icon  Color | To Resume |
|--------------------|--|--|
| Power Off | Off | Press the Power Button |
| Sleep | Blinking Green | Press the Power Button Press the Sleep Button (Fn + F4 Key Combo) |
| Hibernate | Off (battery) Orange (AC/DC adapter) | Press the Power Button |
| Display Turned Off | Green | Press a Key or Move the Mouse/Touchpad |



Closing the Lid

If you have chosen to send the computer to **Sleep** when the lid is closed, raising the lid will wake the system up.



Power Button

When the computer is on, you can use the power button as a Sleep/Hibernate/Shut Down hot key button when it is pressed for less than **4 seconds** (pressing and holding the power button for longer than this will force the computer to shut down).

Power Conservation Modes

This system supports **Energy Star** power management features that place computers (CPU, hard drive, etc.) into a low-power sleep modes after a designated period of inactivity. Adjust **Power Conservation Modes** from the **Control Center**:

1. Press the **Fn + Esc** key combination to toggle the **Control Center** on/off.
2. Click either the **Performance**, **Balanced** or **Energy Star** button.
3. Click in a blank area of the icon or press a key on the keyboard to exit **Power Conservation Mode** without making any changes.



Energy Star Display Sleep Mode

Note that the Energy Star setting will put the display into sleep after no more than 15 minutes of user inactivity.

Power Conservation Modes

The **Energy Star** setting will result in maximum power saving, but with the possible loss of some performance.

Setting the mode to **Balance** will give power saving matched with performance.

Performance will give optimum computer performance but with less power conservation.

Figure 3 - 7 Control Center

Ctrl + Alt + Delete Key Combination

You can use the **CTRL + ALT + DEL** key combination from almost any of the *Windows 8* interfaces/Apps to bring up a full-screen displaying **Lock, Switch User, Log off, Change a password** and **Task Manager** options. If you click the **Power** icon in the lower right corner of the screen a power management option menu appears to display **Sleep, Shut down, and Restart**.

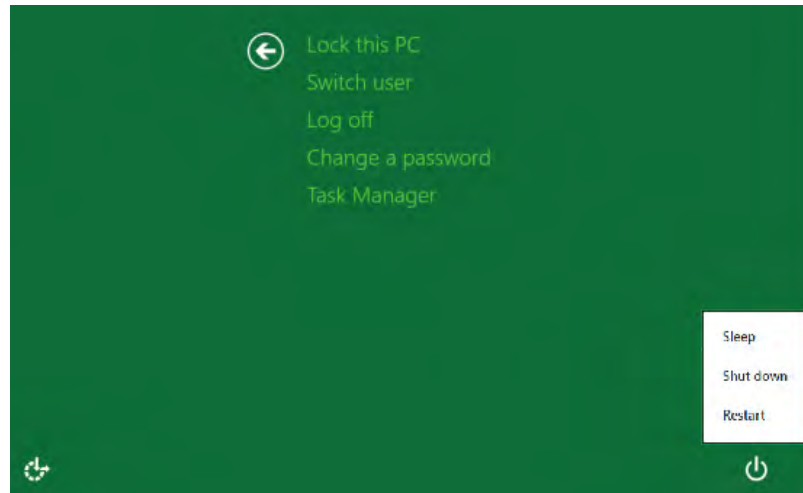

Figure 3 - 8
Ctrl + Alt + Delete
Menu

To fully control all the power options (including Hibernate mode) go to the **Power Options** control panel and configure the power button, sleep button and lid to perform the function selected.

Battery Information

Follow these simple guidelines to get the best use out of your battery.

Battery Power

Your computer’s battery power is dependent upon many factors, including the programs you are running, and peripheral devices attached. You can set actions to be taken (e.g. Shut down, Hibernate etc.), and set critical and low battery levels from power plan **Change plan settings > Change advanced power settings** (see *Figure 3 - 3 on page 3 - 5*).

Click the battery icon  in the notification area to see the current battery level and charge status.

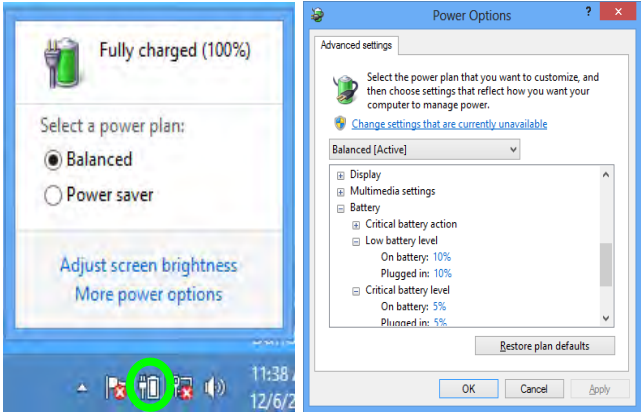



**Low Battery
Warning**

When the battery is critically low, immediately connect the AC/DC adapter to the computer or save your work, otherwise, the unsaved data will be lost when the power is depleted.

Figure 3 - 9
**Battery Icon
(Notification Area) &
Battery Advanced
Settings**



Windows Mobility Center

The **Windows Mobility Center** control panel provides an easy point of access for information on battery status, power plans used and wireless device status etc.

Conserving Battery Power

- Use a **power plan** that conserves power (e.g **Power saver**), however note that this may have an affect on computer performance.
- Lower the brightness level of the LCD display. The system will decrease LCD brightness slightly to save power when it is not powered by the AC/DC adapter.
- Reduce the amount of time before the display is turned off.
- Close wireless, Bluetooth, modem or communication applications when they are not being used.
- Disconnect/remove any unnecessary external devices e.g. USB devices, ExpressCards etc.

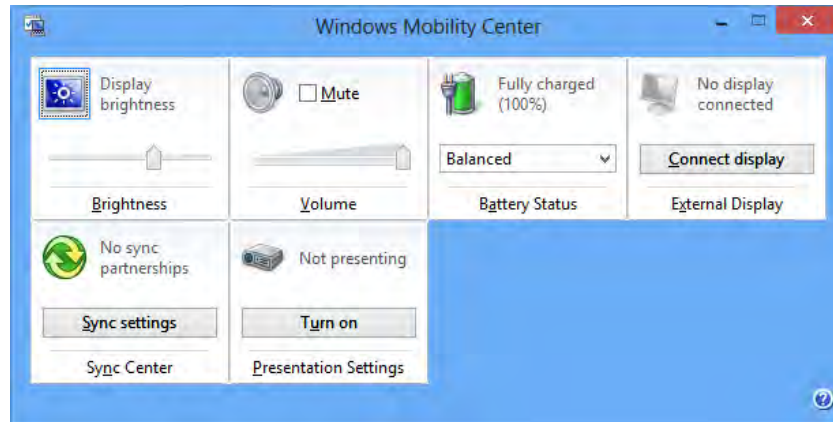

Figure 3 - 10
Windows Mobility Center

Battery Life

Battery life may be shortened through improper maintenance. **To optimize the life and improve its performance, fully discharge and recharge the battery at least once every 30 days.**

We recommend that you do not remove the battery yourself. If you do need to remove the battery for any reason (e.g. long term storage) see *“Removing the Battery” on page 6 - 4.*

New Battery

Always completely discharge, then fully charge, a new battery (see *“Battery FAQ” on page 3 - 17* for instructions on how to do this).

Recharging the Battery with the AC/DC Adapter

The battery pack automatically recharges when the AC/DC adapter is attached and plugged into an electrical outlet. If the computer is powered on, and in use, it will take several hours to fully recharge the battery. When the computer is turned off but plugged into an electrical outlet, battery charge time is less. Refer to *“LED Indicators” on page 1 - 11* for information on the battery charge status, and to *“Battery Information” on page 3 - 13* for more information on how to maintain and properly recharge the battery pack.



Caution

Danger of explosion if battery is incorrectly replaced.

Replace only with the same or equivalent type recommended by the manufacturer. Discard used battery according to the manufacturer's instructions.

Proper handling of the Battery Pack

- DO NOT disassemble the battery pack under any circumstances
- DO NOT expose the battery to fire or high temperatures, it may explode
- DO NOT connect the metal terminals (+, -) to each other



Damaged Battery Warning

Should you notice any physical defects (e.g. the battery is bent out of shape after being dropped), or any unusual smells emanating from the notebook battery, shut your computer down immediately and contact your distributor/supplier. If the battery has been dropped we do not recommend using it any further, as even if the computer continues to work with a damaged battery in place, it may cause circuit damage, which may possibly result in fire. It is recommended that you replace your computer battery every two years.

Battery FAQ

How do I completely discharge the battery?

Use the computer with battery power until it shuts down due to a low battery. Don't turn off the computer even if a message indicates the battery is critically low, just let the computer use up all of the battery power and shut down on its own.

1. Save and close all files and applications.
2. **Create a power plan** for discharging the battery and set all the options to **Never**.

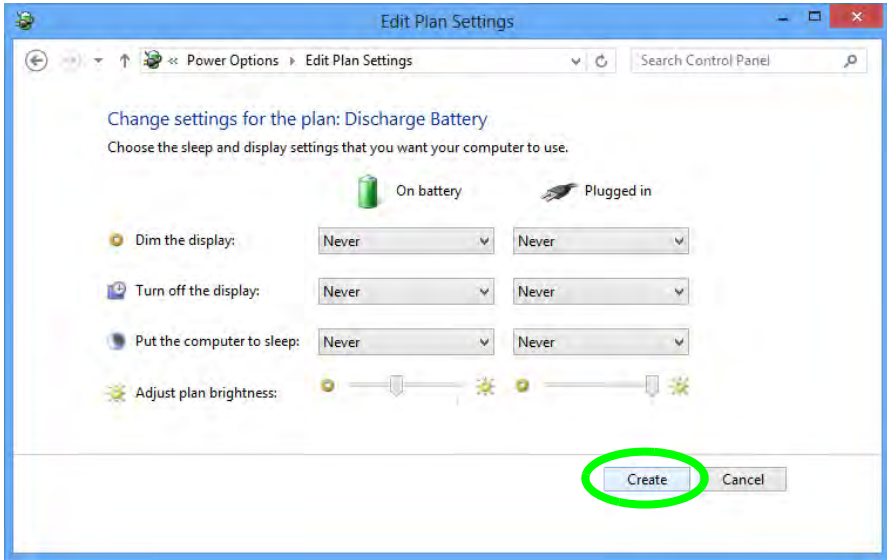
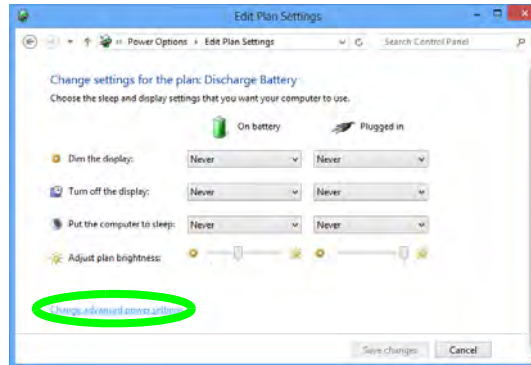
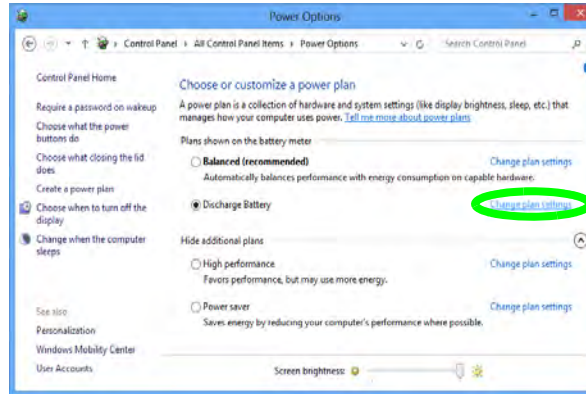

Figure 3 - 11
Power Plan Create

Power Management

3. Click **Change plan settings** (after creating it) and click **Change plan settings > Change advanced power settings**.

Figure 3 - 12
Change Plan
Settings / Change
Advanced Power
Settings



4. Scroll down to **Battery** and click **+** to expand the battery options.
5. Choose the options below (click **Yes** if a warning appears):

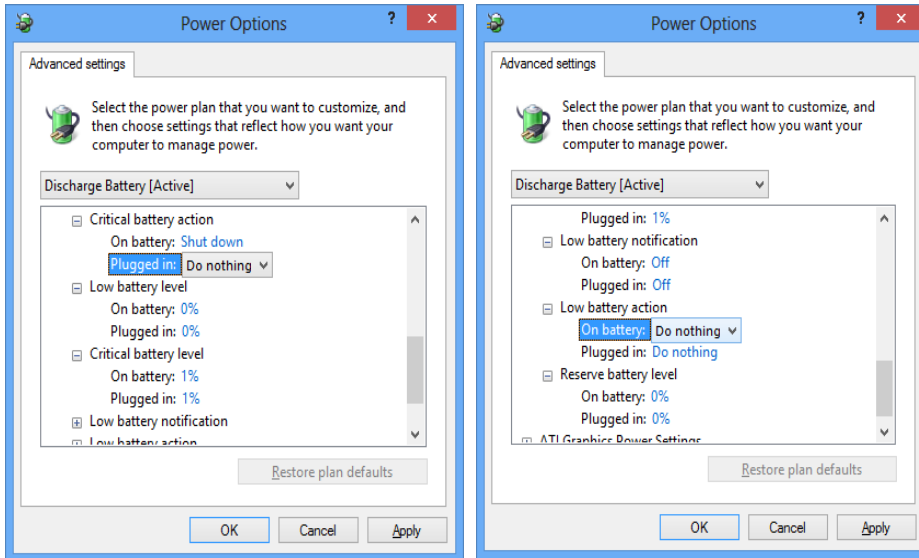

Figure 3 - 13
Power Options
Advanced Settings -
Battery

- Low battery levels = 0%
- Critical battery Levels = 1%
- Low battery action = Do Nothing
- Critical battery action (On battery) = Shut Down
- Critical battery action (Plugged in) = Do Nothing

How do I fully charge the battery?

When charging the battery, don't stop until the LED charging indicator light changes from orange to green.

How do I maintain the battery?

Completely discharge and charge the battery at least once every 30 days or after about 20 partial discharges.

Chapter 4: Drivers & Utilities

This chapter deals with installing the drivers and utilities essential to the operation or improvement of some of the computer's subsystems. The system takes advantage of some newer hardware components for which the latest versions of most available operating systems haven't built in drivers and utilities. Thus, some of the system components won't be auto-configured with an appropriate driver or utility during operating system installation. Instead, you need to manually install some system-required drivers and utilities.

RAID & AHCI Setup

Note that setting up a RAID, or AHCI mode, needs to be done prior to installing the *Windows OS*, and therefore before installing the other drivers listed here (see *“Setting Up SATA RAID or AHCI Mode” on page 7 - 2*).

What to Install

The *Device Drivers & Utilities + User's Manual* disc contains the drivers and utilities necessary for the proper operation of the computer. *Table 4 - 1, on page 4 - 3* lists what you need to install and **it is very important that the drivers are installed in the order indicated**. The procedures for installing drivers for the **WLAN, Fingerprint, Bluetooth & WLAN Combo, TPM, Sound Blaster Audio** and **Intel Technology** modules are provided in *“Modules” on page 7 - 1*.



Driver Installation & Power

When installing drivers make sure your computer is powered by the AC/DC adapter connected to a working power source. Some drivers draw a significant amount of power during the installation procedure, and if the remaining battery capacity is not adequate this may cause the system to shut down and cause system problems (note that there is no safety issue involved here, and the battery will be rechargeable within 1 minute).

Driver Installation

1. Insert the *Device Drivers & Utilities + User's Manual* disc into the computer's DVD drive.
2. Click the message "Tap to choose what happens with this disc."
3. Click **Run autorun.exe**.
4. Click **Install Drivers** (button), or **Option Drivers** (button) to access the **Optional** driver menu.



Figure 4 - 1- Drivers Installer Screen 1

5. Check the driver installation order from **Table 4 - 1, on page 4 - 3** (the drivers must be installed in this order) which is the same as that listed in the **Drivers Installer** menu below.
6. Click to select the driver you wish to install, (you should note down the drivers as you install them).
7. Follow the instructions for each individual driver installation procedure as listed on the following pages.



Figure 4 - 2 - Drivers Installer Screen 2

| Win 8 Driver | Page # | Optional Items | |
|-----------------------------|-------------------|---|--------------------|
| <i>Chipset</i> | <i>Page 4 - 6</i> | <i>Setting Up SATA RAID or AHCI Mode</i> (for RAID & AHCI mode Hard Disk Drives) | <i>Page 7 - 2</i> |
| <i>Video (VGA) - NVIDIA</i> | <i>Page 4 - 6</i> | <i>PC Camera Module</i> (No driver required) | <i>Page 7 - 12</i> |
| <i>LAN</i> | <i>Page 4 - 6</i> | <i>Wireless LAN Module</i> | <i>Page 7 - 19</i> |
| <i>Card Reader</i> | <i>Page 4 - 7</i> | <i>Fingerprint Reader Module</i> | <i>Page 7 - 34</i> |
| <i>Touchpad (Clickpad)</i> | <i>Page 4 - 7</i> | <i>BioExcess Application</i> | <i>Page 7 - 46</i> |
| <i>Airplane</i> | <i>Page 4 - 7</i> | <i>Trusted Platform Module</i> | <i>Page 7 - 63</i> |
| <i>Hot Key</i> | <i>Page 4 - 7</i> | <i>Sound Blaster Audio</i> | <i>Page 7 - 77</i> |
| <i>MEI Driver</i> | <i>Page 4 - 7</i> | <i>Intel® Rapid Storage Technology</i> | <i>Page 7 - 86</i> |
| <i>Thunderbolt Port</i> | <i>Page 4 - 7</i> | <i>Intel® Rapid Start Technology Driver</i> | <i>Page 7 - 96</i> |
| <i>Audio</i> | <i>Page 4 - 7</i> | | |

Table 4 - 1 - Driver Installation

All drivers provided are for Windows 8 operating system.

Note that you need to install both the WLAN & Bluetooth drivers for the WLAN & Bluetooth Combo modules, however the Qualcomm Atheros WLAN (Combo) module only requires the WLAN driver installation.

Manual Driver Installation

Click **Browse CD/DVD** (button) in the *Drivers Installer* application and browse to the executable file in the appropriate driver folder.

4

Windows Update

After installing all the drivers make sure you enable **Windows Update** in order to get all the latest security updates etc. (all updates will include the latest **hotfixes** from Microsoft). See [“Windows Update” on page 4 - 9](#) for instructions.

Updating/Reinstalling Individual Drivers

If you wish to update/reinstall individual drivers it may be necessary to uninstall the original driver. To do this go to the **Control Panel** in the *Windows OS* and double-click the **Programs and Features** icon (**Programs > Uninstall a program**). Click to select the driver (if it is not listed see below) and click **Uninstall**, and then follow the on screen prompts (it may be necessary to restart the computer). Reinstall the driver as outlined in this chapter.

If the driver is not listed in the **Programs and Features** menu:

1. Go to the **Control Panel**).
2. Double-click **Device Manager (Hardware and Sound > Devices and Printers > Device Manager)**.
3. Double-click the **device** you wish to update/reinstall the driver for (you may need to click “+” to expand the selection).
4. Click **Driver** (tab) and click the **Update Driver** or **Uninstall** button and follow the on screen prompts.

User Account Control

If a **User Account Control** prompt appears as part of the driver installation procedure, click **Continue** or **Allow**, and follow the installation procedure as directed.

Windows Security Message

If you receive a *Windows* security message as part of the driver installation process. Just click “*Install this driver software anyway*” or “*Install*” to continue the installation procedure.

You will receive this message in cases where the driver has been released after the version of *Windows* you are currently using. All the drivers provided will have already received certification for *Windows*.

New Hardware Found

If you see the message “**New Hardware Found**” during the installation procedure (**other than when outlined in the driver install procedure**), click **Cancel** to close the window, and follow the installation procedure.



Driver Installation General Guidelines

The driver installation procedure outlined in this Chapter (and in **Chapter 7 Options & Modules**), are accurate at the time of going to press.

Drivers are always subject to upgrade and revision so the exact procedure for certain drivers may differ slightly. As a general guide follow the default on screen instructions for each driver (e.g. **Next > Next > Finish**) unless you are an advanced user. In many cases a restart is required to install the driver.

Make sure any modules (e.g. WLAN or Bluetooth) are **ON (i.e. the system is not in Airplane Mode)** before installing the appropriate driver.

RAID Note: Setting up a **RAID**, or **AHCI** mode, needs to be done prior to installing the *Windows OS*, and therefore before installing the other drivers listed here.

Driver Installation Procedure

Insert the *Device Drivers & Utilities + User's Manual disc* and click **Install Drivers** (button).

Chipset

1. Click **1.Install Chipset Driver > Yes**.
2. Click **Next > Yes > Next > Next**.
3. Click **Finish** to restart the computer.



Video Driver Installation

Note that the system will install either the NVIDIA Video driver **or** AMD video driver as appropriate for purchase option.

Video (VGA) - NVIDIA

1. Click **2.Install VGA Driver > Yes**.
2. Click **AGREE AND CONTINUE** (button) to accept the terms of the license agreement.
3. Click **Next**.
4. Click the **Close** button to complete the installation.

OR

Video (VGA) - AMD

1. Click **2.Install VGA Driver > Yes**.
2. Click **Next > Install** (button).
3. Click the **Express** (or **Custom** if you prefer to manually configure the driver installation settings) button and click **Next**.
4. Click **Accept** (button).
5. Click **Finish > Yes** to restart the computer.

LAN

1. Click **3.Install LAN Driver > Yes**.
2. Click **Next > Install**.
3. Click **Finish**.

Card Reader

1. Click **4.Install Cardreader Driver > Yes**.
2. Click **Finish** to complete the installation.

Touchpad (Clickpad)

1. Click **5.Install Touchpad Driver > Yes**.
2. Click **Next**.
3. Click the button to accept the license, and then click **Next**.
4. Click **Finish > Restart Now** to restart the computer.

Airplane

1. Click **6.Install Airplane Driver > Yes**.
2. Click **Next**.
3. Click **Finish** to restart the computer.

Hot Key

1. Click **7.Install Hotkey AP > Yes**.
2. Click **Next > Next**.
3. Click **Finish > Finish** to restart your computer.

MEI Driver

1. Click **8.Install MEI Driver > Yes**.
2. Click **Next > Yes > Next**.
3. Click **Finish**.

Thunderbolt Port

1. Click **9. Install TBT Driver > Yes**.
2. Click the tickbox to accept the license, and then click **Install**.
3. Click **OK**.
4. Click **Finish**.
5. See *“Thunderbolt Port” on page A - 4* for more information.

Audio

1. Click **10. Install Audio Driver > Yes**.
2. Click **Next**.
3. Click **Finish** to restart the computer.

Drivers & Utilities

After installing the audio driver the system will not return to the **Drivers Installer** screen. To install any of the optional drivers, eject the *Device Drivers & Utilities + User's Manual* disc and then reinsert it (or double-click the disc icon in My Computer), and click **Option Drivers** (button) to access the optional driver menu.

It is recommended that you install the **Sound Blaster Audio** application (see "*Sound Blaster Audio*" on page 7 - 98) and **Intel Rapid Storage Technology** driver (see "*Intel® Rapid Storage Technology*" on page 7 - 79 - required for AHCI & RAID mode).

(see over)



Windows Update

After installing all the drivers make sure you enable **Windows Update** in order to get all the latest security updates etc. (all updates will include the latest **hotfixes** from Microsoft).

To enable **Windows Update** make sure you are **connected to the internet**:

1. Go to the **Control Panel**.
2. Click **Windows Update** (System and Security/ Security).
3. Click **Check for updates** (button).
4. The computer will now check for updates (you need to be connected to the internet).
5. Click **Install now** (button) to begin checking for the updates.
6. Click **Install updates** (button) to install the updates.

Windows Experience Index

After the drivers are installed follow this procedure to ensure an accurate rating from the *Windows Experience Index* (make sure the AC/DC adapter is plugged in):

1. Go to the **Control Panel**.
2. Click **Performance Information and Tools** (**System and Security > System > Windows Experience Index**).
3. Click “**Rate this computer/Refresh Now/Rerun the assessment**”.
4. The computer will take a few minutes to assess the system performance.
5. Close the control panel.

Optional Drivers

See the pages indicated for the driver installation procedures for any modules included in your purchase option.



Figure 4 - 3 - Drivers Installer (Options)

Note that you need to install both the WLAN & Bluetooth drivers for the WLAN & Bluetooth Combo modules, however the Qualcomm Atheros WLAN (Combo) module only requires the WLAN driver installation.

Chapter 5: BIOS Utilities

Overview

This chapter gives a brief introduction to the computer's built-in software:

Diagnostics: The **POST** (Power-On Self Test)

Configuration: The *Setup* utility

If your computer has never been set up, or you are making important changes to the system (e.g. hard disk setup), then you should review this chapter first and note the original settings found in *Setup*. Even if you are a beginner, keep a record of the settings you find and any changes you make. This information could be useful if your system ever needs servicing.

There is one general rule: *Don't make any changes unless you are sure of what you are doing*. Many of the settings are required by the system, and changing them could cause it to become unstable or worse. If you have any doubts, consult your service representative.



BIOS Screens

Note that the BIOS screens pictured on these pages are intended for guidance in setting up your system's BIOS.

BIOS versions are subject to constant change and revision, therefore your computer's actual screens may appear slightly different from those pictured on these pages.



BIOS Settings Warning

Incorrect settings can cause your system to malfunction. To correct mistakes, return to *Setup* and restore the *Previous Values* with <F2>, or *Optimized Defaults* with <F3>.

UEFI Boot & POST

When UEFI Boot is enabled, then the prompts to **press F2 or F7 will not appear**. However you can still press F2 to enter the setup, or F7 to choose the preferred boot device, if you press the key immediately the system boots up.

The Power-On Self Test (POST)

If you enable the **Boot-time Diagnostic Screen** in the Setup Utility, each time you turn on the computer the system takes a few seconds to conduct a **POST**, including a quick test of the on-board RAM (memory).

As the **POST** proceeds, the computer will tell you if there is anything wrong. If there is a problem that prevents the system from booting, it will display a system summary and prompt you to run *Setup*.

If there are no problems, the *Setup* prompt will disappear and the system will load the operating system. Once that starts, you can't get into *Setup* without rebooting.

Failing the POST

Errors can be detected during the **POST**. There are two categories, “fatal” and “non-fatal”.

Fatal Errors

These stop the boot process and usually indicate there is something seriously wrong with your system. Take the computer to your service representative or authorized distributor/supplier as soon as possible.

Non-Fatal Errors

This kind of error still allows you to boot. You will get a message identifying the problem (make a note of this message!) followed by the prompt:

- Press <F1> to resume
- <F2> to enter Setup

Press **F1** to see if the boot process can continue. It may work, without the correct configuration.

Press **F2** to run the **Setup** program and try to correct the problem. If you still get an error message after you change the setting, or if the “cure” seems even worse, call for help.



BIOS Settings Warning

Incorrect settings can cause your system to malfunction. To correct mistakes, return to *Setup* and restore the *Previous Values* with <F2>, or *Optimized Defaults* with <F3>.

The Setup Utility

The **Aptio Setup Utility** tells the system how to configure itself and manage basic features and subsystems (e.g. port configuration).

Entering Setup

To enter *Setup*, turn on the computer and press **F2** during the **POST**. The prompt “*Press F2 to Enter Setup*” is usually present for a few seconds after you turn on the system. If you get a “Keyboard Error”, (usually because you pressed **F2** too quickly) just press **F2** again.

If the computer is already on, reboot using the **Ctrl + Alt + Delete** combination and then hold down **F2** when prompted. The *Setup* main menu will appear.

Setup Screens

The following pages contain additional advice on portions of the *Setup*. Along the top of the screen is a menu bar with menu headings. When you select a heading, a new screen appears. Scroll through the features listed on each screen to make changes to *Setup*.

Instructions on how to navigate each screen are in the box at the bottom right side of the screen.

```
→←: Select Screen
↑↓: Select Item
Enter: Select
+/-: Change Opt.
F1: General Help
F3: Optimized Defaults
F4: Save Changes & Exit
ESC: Exit
```

If these tools are confusing, press **F1** to call up a **General Help** screen, and then use the arrow keys to scroll up or down the page.

The **Item Specific Help** on the upper right side of each screen explains the highlighted item and has useful messages about its options.

If you see an arrow ► next to an item, press **Enter** to go to a sub-menu on that subject. The sub-menu screen that appears has a similar layout, but the **Enter** key may execute a command.



Setup Menu

The **Setup** menus shown in this section are for **reference** only. Your computer's menus will indicate the configuration appropriate for your model and options.

Figure 5 - 1
Navigation Menu

Main Menu

Figure 5 - 2
Main Menu

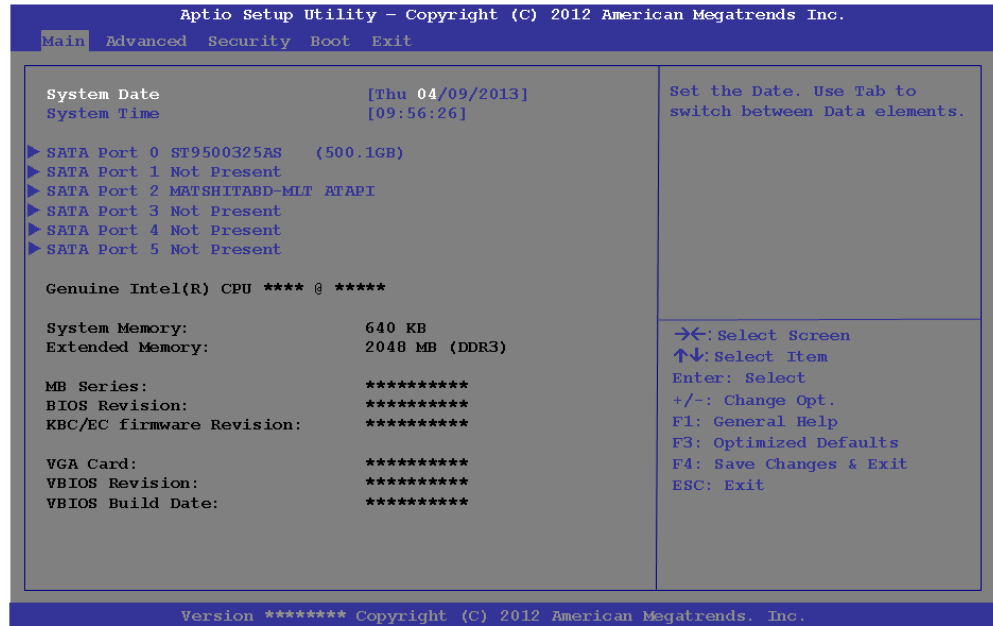

System Time & Date (Main Menu)

The hour setting uses the 24-hour system (i.e., 00 = midnight; 13 = 1 pm). If you can change the date and time settings in your operating system, you will also change these settings. Some applications may also alter data files to reflect these changes.

SATA Port # (Main Menu)

Pressing **Enter** opens the sub-menu to show the configuration of a optical Device/ HDD on the computer's SATA ports.

System/Extended Memory (Main Menu)

This item contains information on the system memory, and is not user configurable. The system will auto detect the amount of memory installed.

BIOS Revision/ KBC/EC firmware Revision / VGA Card / VBIOS etc. (Main Menu)

This item contains information on the BIOS version and video card etc., and is not user configurable.

Advanced Menu

Figure 5 - 3
Advanced Menu

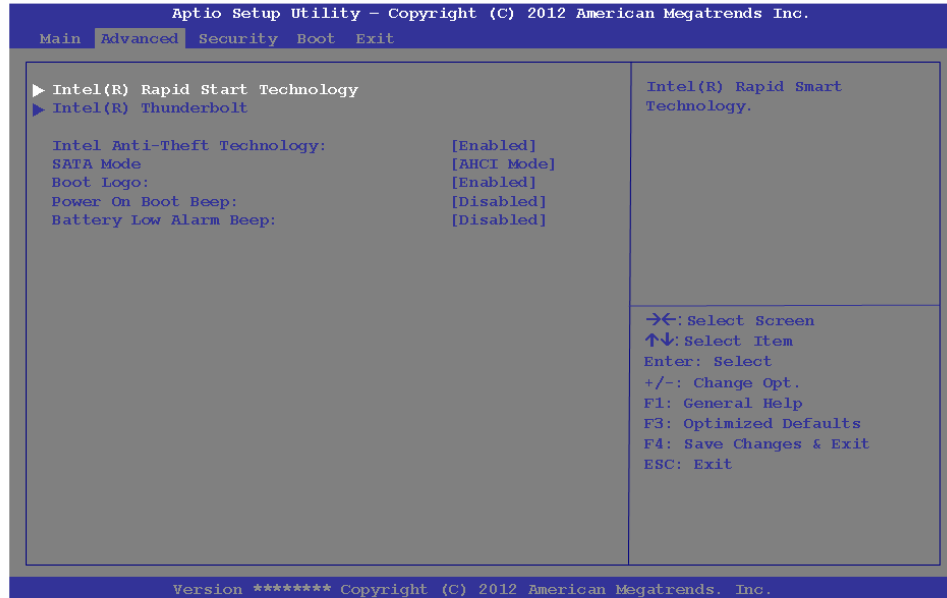

Intel(R) Rapid Start Technology (Advanced Menu)

Enable/disable **Intel(R) Rapid Start Technology** from this menu. The rapid start hibernation mode can resume power within 5 to 6 seconds and can remember your computer's state with zero power.

Intel(R) Thunderbolt (Advanced Menu)

You can configure the Intel Thunderbolt port's security level here in **Legacy Mode**, as **Unique ID** or **DP++ Only**.

Intel(R) Anti-Theft Technology (Advanced Menu)

Anti-Theft Technology, which is built-in to the processor of the computer, allows system administrators to render your computer useless to thieves by sending a poison pillencrypted SMS message over a 3G network etc. Administrators can also remotely unlock a recovered computer quickly, or direct the system to send location information (GPS coordinates) back to a central server.



SATA Mode Selection

Set the SATA mode **BEFORE** installing your *Windows OS*. Do not change the mode unless you intend to reinstall your operating system, and make sure you back up all necessary files and data before doing so.

If you wish to change the SATA mode see *“Changing The SATA Mode” on page 8 - 14*.

Figure 5 - 4
SATA Mode Change Notification

SATA Mode (Advanced Menu)

You can configure SATA (Serial ATA) control to operate in **IDE** (native/compatible), **AHCI** (Advanced Host Controller Interface) or **RAID** (Redundant Array of Independent Disks) modes from this menu. The **SATA mode** should be set **BEFORE installing an operating system**, and after you have backed up all necessary files and data (see sidebar). See *“Setting Up SATA RAID or AHCI Mode” on page 7 - 2* for details if you are configuring your hard disks in a **RAID**.

If you wish to change your SATA mode to/from AHCI/RAID/IDE mode you will receive a message (see below) to notify you that doing so may prevent your operating system from booting, and may require a reinstall of the OS. If you do wish to change the SATA mode then backup any necessary data on your hard disk(s) as you will need wipe the disks clean in order to prevent system problems (see *“Changing The SATA Mode” on page 8 - 14*).

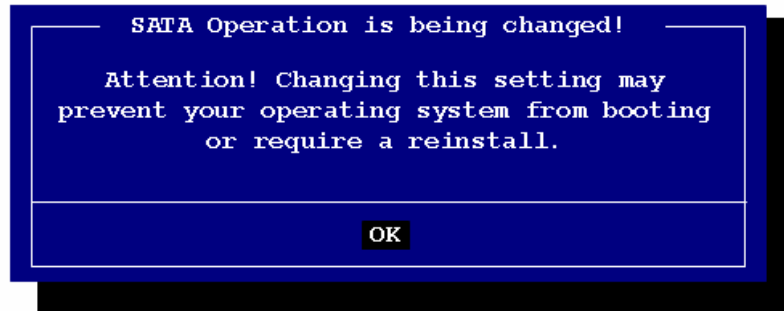

Boot Logo (Advanced Menu)

Use this menu item to enable/disable the **Boot Logo** screen at system startup **if you have not enabled UEFI Boot**. If you disable the **Boot Logo** you will not see the **F2 Enter Setup** or **F7 Boot Options** prompts on the screen, however you can still press these keys, while the boot screen is displayed, to perform the Enter Setup or Boot Option functions.

Power On Boot Beep (Advanced Menu)

Use this menu item to enable/disable the beep as the computer starts up.

Battery Low Alarm Beep (Advanced Menu)

Use this menu item to enable/disable the battery low alarm beep.



Security Menu

The changes you make here affect the access to the **Setup** utility itself, and also access to your machine as it boots up after you turn it on. These settings do not affect your machine or network passwords which will be set in your software OS.

Figure 5 - 5
Security Menu

Security Menu



Set Supervisor Password (Security Menu)

You can set a password for access to the **Aptio Setup Utility**. This will not affect access to the computer OS (only the **Aptio Setup Utility**).

Note: To clear existing passwords press **Enter** and type the existing password, then press **Enter** for the new password (without typing any password entry) and **Enter** again to confirm the password clearance.

Set User Password (Security Menu)

You can set a password for user mode access to the **Aptio Setup Utility**. This will not affect access to the computer OS, (only the *Setup* utility) unless you choose to set a **Password on Boot** (see below). Many menu items in the **Aptio Setup Utility** cannot be modified in user mode. You can only set the user password after you have set the supervisor password.

Password on boot (Security Menu)

Specify whether or not a password should be entered to boot the computer (**you may only set a password on boot if a supervisor password is enabled**). If “*Enabled*” is selected, only users who enter a correct password can boot the system (**see the warning in the sidebar**). The default setting is “*Disabled*”.

Note: To clear existing passwords press **Enter** and type the existing password, then press **Enter** for the new password (without typing any password entry) and **Enter** again to confirm the password clearance.

Secure Boot Control (Security Menu)

Secure Boot prevents unauthorized operating systems and software from loading during the startup process. **Secure Boot Control** is available as a menu option if you have **enabled UEFI Boot** (see “*UEFI Boot (Boot Menu)*” on page 5 - 18). Enabling Secure Boot Control will bring up the **Secure Boot Mode** menu to enable you to configure **Secure Boot** as **Standard** (with a fixed secure boot policy), or **Custom** (which enables you to make changes to the **Key Management** database).



Password Warning

If you set a boot password (Password on boot is “Enabled”), **NEVER** forget your password.

The consequences of this could be serious. If you cannot remember your boot password you must contact your vendor and you may lose all of the information on your hard disk.

TPM Configuration (Security Menu)

This sub-menu will allow you to enable/disable Trusted Platform Module (TPM) support, and to configure the TPM State. Select **TPM Configuration** and press Enter to access the sub-menu. Press Enter to access the **Security Device Support** menu and select **Enable** to display the full TPM configuration menu (see *“Trusted Platform Module” on page 7 - 63* for details).

Figure 5 - 6
TPM Support

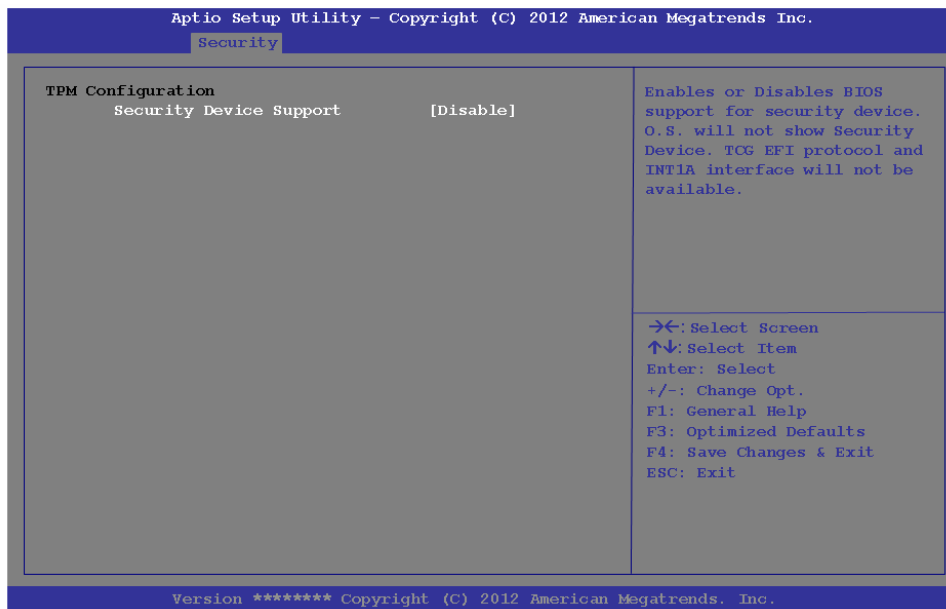

TPM State (Security Menu > Security Device Support Enabled)

Select **TPM State**, press Enter and select **Enabled** to change the TPM state to enabled. You will then need to press **F4** to save the changes and restart the computer.

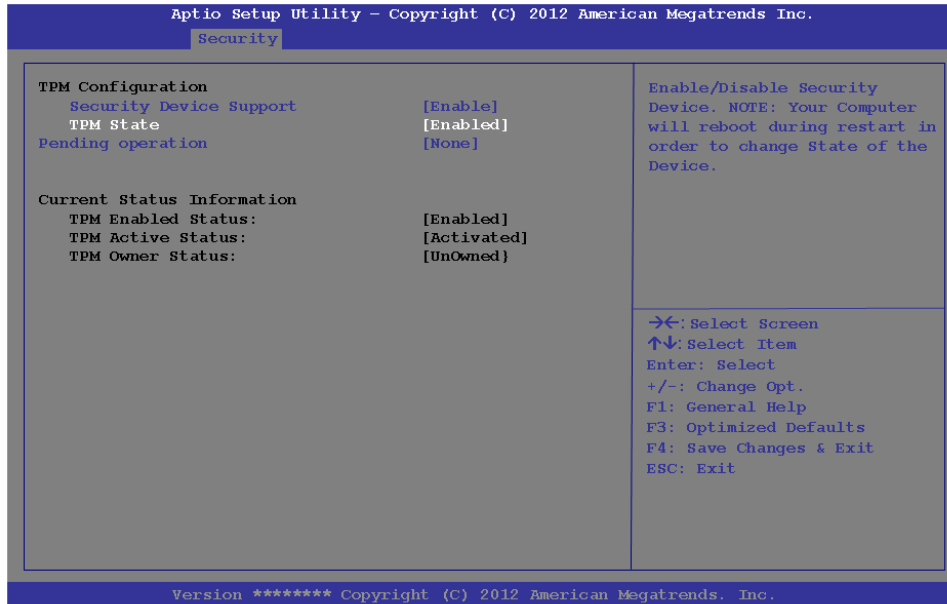

Figure 5 - 7
TPM State (Enabled)

As the computer restarts press **F2** to enter the BIOS again and go to the **TPM Configuration** menu.

Pending TPM operation (Security Menu > Security Device Support Enabled & TPM State Enabled)

Select **Pending TPM operation**, press Enter and select the option you require (if you are initializing TPM you should select **Enable Take Ownership**). You will then need to press **F4** to save the changes and restart the computer. You can now install the TPM driver (see *“Trusted Platform Module (TPM) Driver Installation” on page 7 - 66*) and then initialize the TPM.

Figure 5 - 8
Pending TPM operation (Enable Take Ownership)

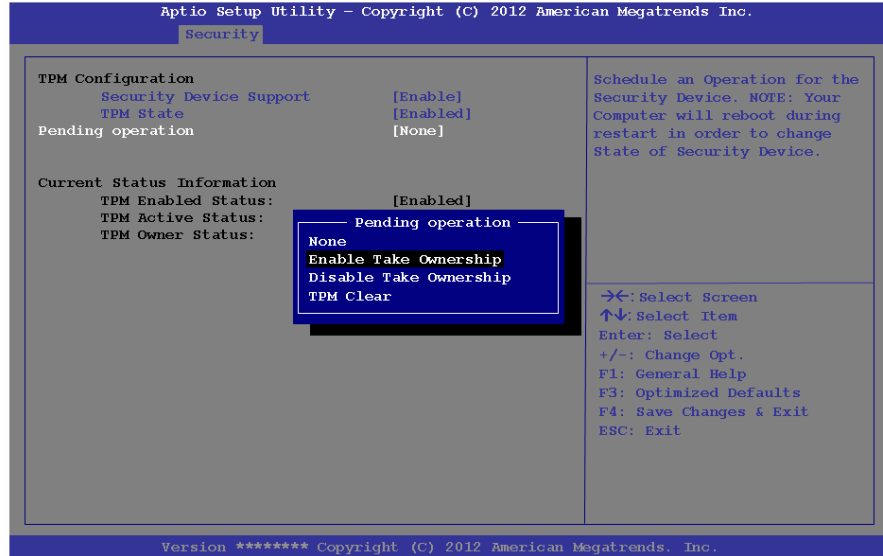

Boot Menu

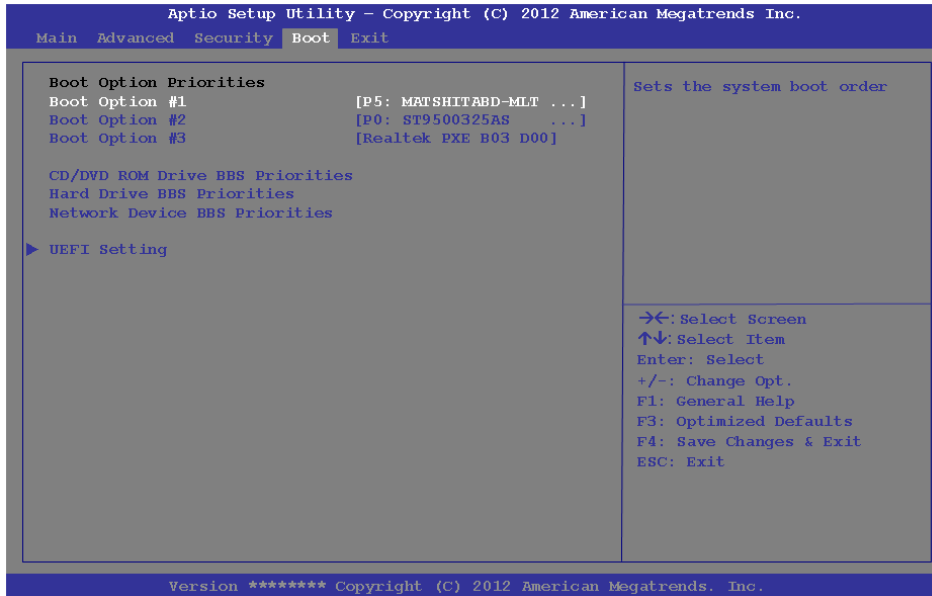

Figure 5 - 9
Boot Menu

5



BIOS Screens

Note that the BIOS screens pictured on these pages are intended for guidance in setting up your system's BIOS.

BIOS versions are subject to constant change and revision, therefore your computer's actual screens may appear slightly different from those pictured on these pages.

When you turn the computer on it will look for an operating system (e.g. *Windows* 7) from the devices listed in this menu, and **in this priority order**. If it cannot find the operating system on that device, it will try to load it from the next device in the order specified in the **Boot Option Priorities**.

Boot Option Priorities (Boot Menu)

Press Enter to select the Boot Option # and use the arrow keys to select any device in order to move its boot priority up and down the list (the selected device will be highlighted in white).

UEFI Boot (Boot Menu)

Enable/disable UEFI Boot from this menu. The Unified Extensible Firmware Interface (UEFI) specification provides a clean interface between operating systems and platform firmware at boot time. In contrast to BIOS, UEFI defines a set of standard boot and runtime services. The *Network Stack* and *PXE Support* items will be enabled as an option under UEFI Boot.

Exit Menu

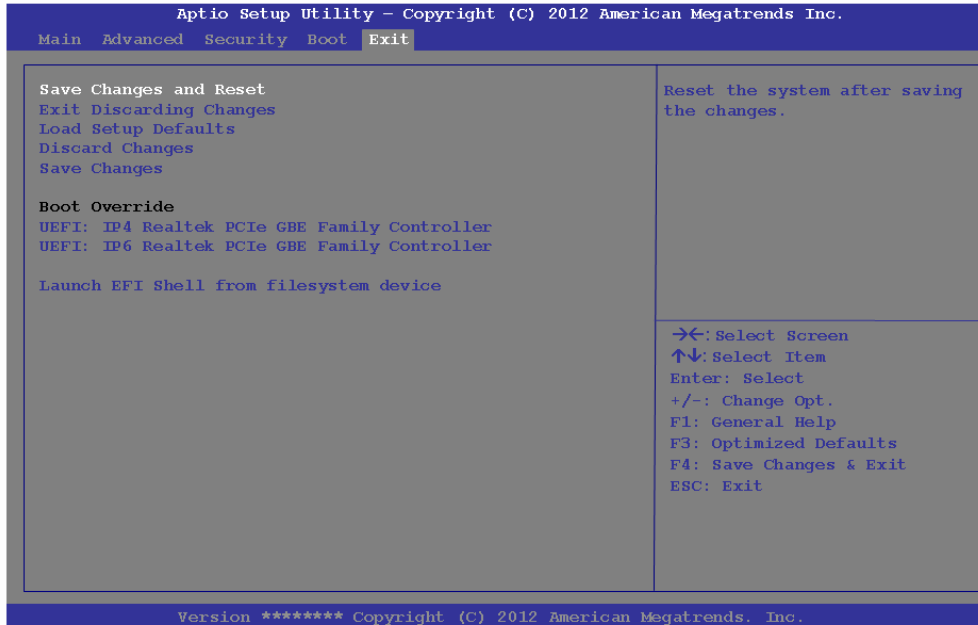

Figure 5 - 10
Exit Menu

Choosing to *Discard Changes*, or *Exit Discarding Changes*, will wipe out any changes you have made to the *Setup*. You can also choose to restore the original *Setup* defaults that will return the *Setup* to its original state, and erase any previous changes you have made in a previous session.

Chapter 6: Upgrading The Computer

Overview

This chapter contains information on upgrading the computer. Follow the steps outlined to make the desired upgrades. If you have any trouble or problems you can contact your service representative for further help. Before you begin you will need:

- A small crosshead or Phillips screwdriver
- A small regular slotted (flathead) screwdriver
- An antistatic wrist strap

Before working with the internal components you will need to wear an antistatic wrist strap to ground yourself because static electricity may damage the components.

The chapter includes:

- Removing the Battery
- Upgrading the Optical (DVD) Device
- Upgrading the Hard Disk Drive(s)
- Upgrading the System Memory (RAM)

Please make sure that you review each procedure before you perform it.



Warranty Warning

Please check with your service representative before undertaking any upgrade procedures to find out if this will VOID your warranty.



Power Safety Warning

Before you undertake any upgrade procedures, make sure that you have turned off the power, and disconnected all peripherals and cables (including telephone lines and power cord).

You must also remove your battery in order to prevent accidentally turning the machine on. **Before removing the battery disconnect the AC/DC adapter from the computer.**

When Not to Upgrade

These procedures involve opening the system's case, adding and sometimes replacing parts. You should **not** perform any of these upgrades if:

- Your system is still under warranty or a service contract
- You don't have all the necessary equipment
- You're not in the correct environment
- You doubt your abilities

Under any of these conditions, contact your service representative to purchase or replace the component(s).



Removal Warning

When removing any cover(s) and screw(s) for the purposes of device upgrade, remember to replace the cover(s) and screw(s) before restoring power to the system.

Also note the following when the cover is removed:

- Hazardous moving parts.
- Keep away from moving fan blades.

Upgrading the Processor or Video Cards

If you want to upgrade your computer by replacing the existing processor with a faster/new one, by adding/changing a video card, or secondary system memory you will need to contact your distributor/supplier. We recommend that you do not do this yourself, since if it is done incorrectly you may damage the processor or mainboard etc.



Warranty Warning

Please check with your service representative before undertaking any upgrade procedures to find out if this will VOID your warranty.

Removing the Battery

If you are confident in undertaking upgrade procedures yourself, for safety reasons it is best to remove the battery. **Before removing the battery disconnect the AC/DC adapter from the computer first.**

1. Turn the computer off, remove the AC/DC adapter and turn it over.
2. Slide the latch **1** in the direction of the arrow.
3. Slide the latch **2** in the direction of the arrow, and hold it in place.



Figure 6 - 1
Battery Unlock

For Model A & C Computers:

- Lift the battery up out of the bay at point ③ and remove it ④.

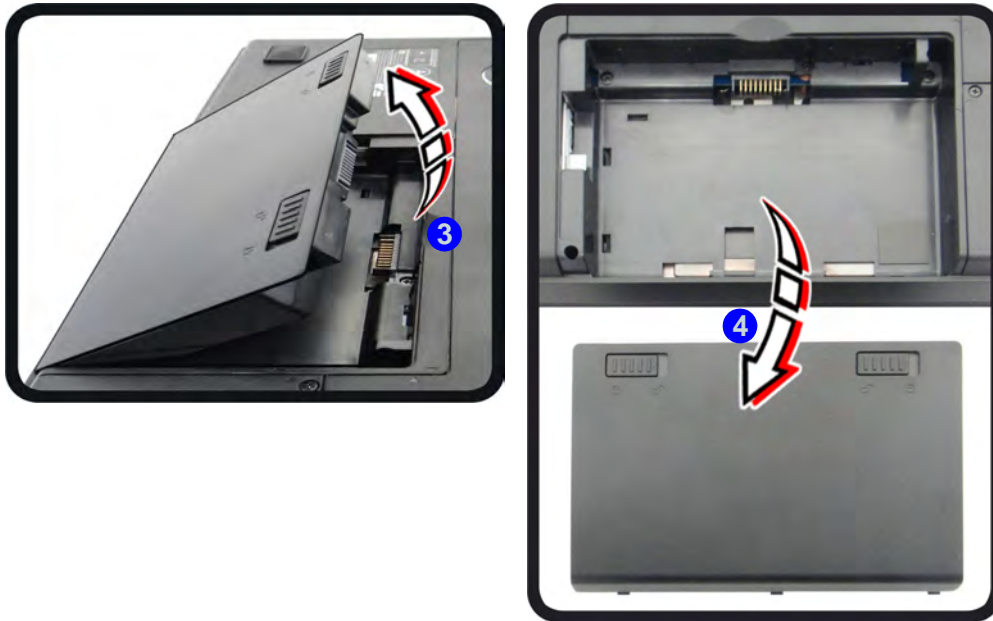

Figure 6 - 2
Battery Removal
(Model A & C
Computers)

Upgrading The Computer

For Model B Computers:

5. Slide the battery forward in the direction of the arrow on the battery **3** until the markers on the battery and case align **4**.
6. Lift the battery up out of the bay and remove it **5**.
7. When replacing the battery insert it on to the case until the case markers align **6**, and then slide it until it locks.

Figure 6 - 3
Battery Removal
(Model B
Computers)

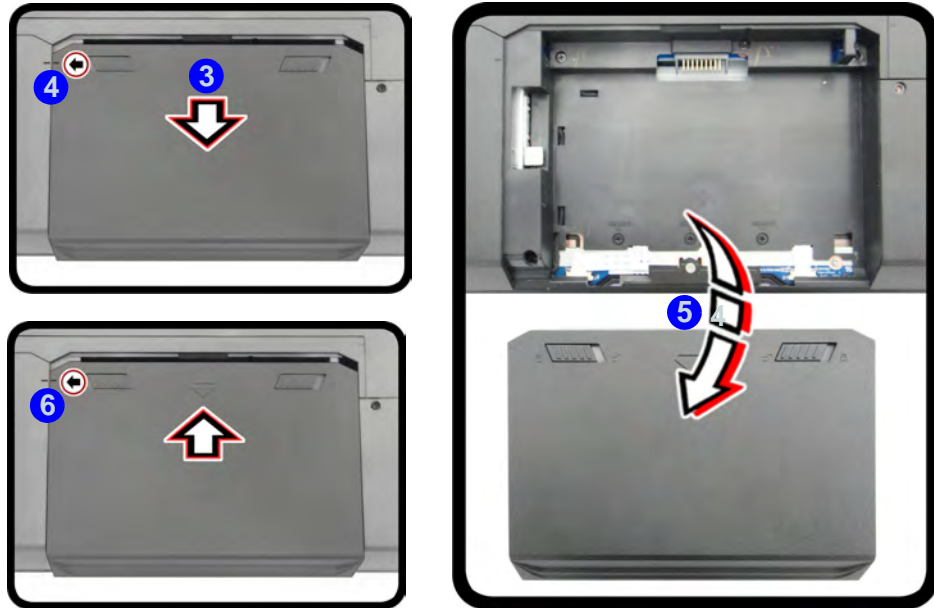

Upgrading the Optical (DVD) Device

1. Turn the computer off, remove the AC/DC adapter, turn it over and remove the battery.
2. Remove the screw at point ①, and use a screwdriver to carefully push out the optical device at point ②.
3. Reverse the process to install any new optical device.

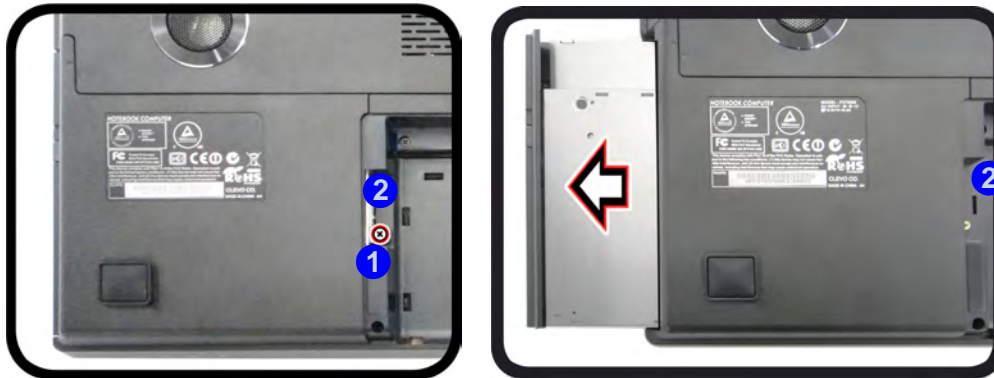

Figure 6 - 4
Removing the DVD
Device



HDD System Warning

New HDD's are blank. Before you begin make sure:
You have backed up any data you want to keep from your old HDD.

You have all the CD-ROMs and FDDs required to install your operating system and programs.

If you have access to the internet, download the latest application and hardware driver updates for the operating system you plan to install. Copy these to a removable medium.

Upgrading the Hard Disk Drive(s)

The hard disk drive(s) can be taken out to accommodate other 2.5" serial (SATA) hard disk drives with a height of 9.5mm (h) (see *“Storage” on page E - 3*). The hard disk bay contains two slots (upper and lower) for up to two hard disks.

Follow your operating system's installation instructions, and install all necessary drivers and utilities (as outlined in *“Drivers & Utilities” on page 4 - 1*), when setting up a new hard disk.

Removing the Hard Disk from the Upper HDD Bay Slot

1. Turn the computer off, remove the AC/DC adapter, turn it over and remove the battery.
2. Locate the hard disk bay cover and remove screw ①.
3. Slide the case cover ② until the case markers ③ align.
4. Remove the hard disk bay cover ④.
5. Remove screws ⑤ & ⑥ from the hard disk assembly.



RAID Hard Disks

All hard disks in a RAID should be identical (the same size and brand) in order to prevent unexpected system behavior.

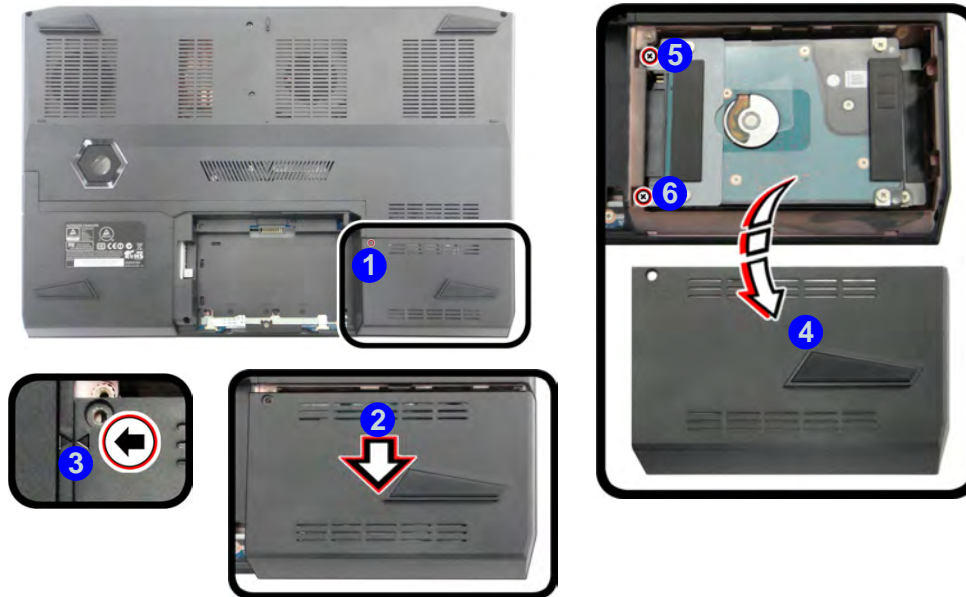

Figure 6 - 5
HDD Bay Cover
Screw & Cover
Removal

Upgrading The Computer

6. Carefully pull up the tab to move the HDD assembly in the direction of arrow 7.
7. Lift the HDD assembly out of the bay 8.

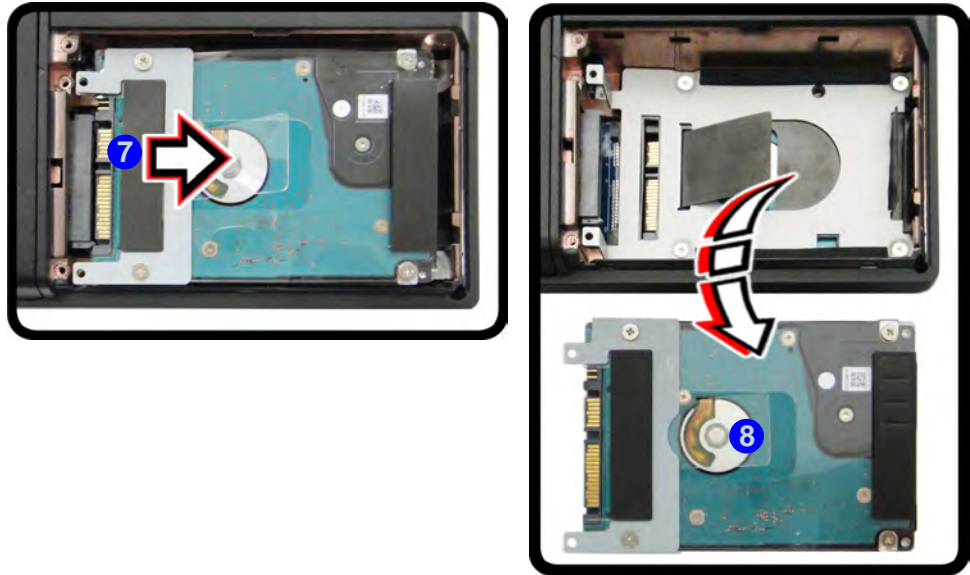

Figure 6 - 6
**Upper Slot Hard
Disk Assembly
Removal**

6

- Remove screws **9** - **12** and separate the hard disk from the insulation plate **13**.
- Reverse the process to install any new disk (and do not forget to install the insulation plate and screws (see over for cover).

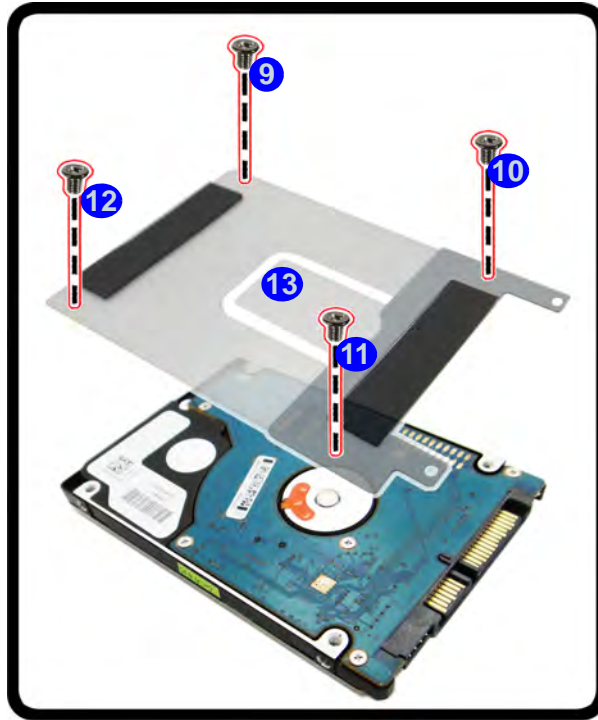

Figure 6 - 7
**Upper Bay Hard
Disk Insulation Plate
Removal**

Inserting the Hard Disk into the Upper HDD Bay Slot

1. Insert the HDD assembly into the bay at the angle indicated by arrow ①.
2. Place the HDD assembly flat into the bay as indicated by arrow ②.
3. Slide the assembly firmly into the connector (the reverse direction to the arrow in [Figure 6 - 6 on page 6 - 10](#)).

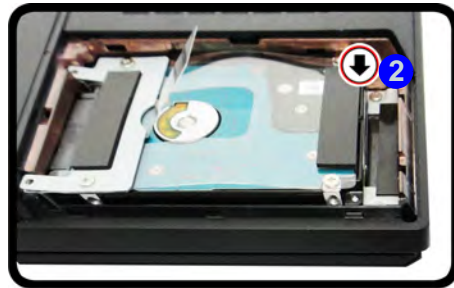

Figure 6 - 8
HDD Assembly
Insertion

Removing the Hard Disk from the Lower HDD Bay Slot

1. Turn the computer off, remove the AC/DC adapter, turn it over and remove the battery and any HDD in the upper slot.
2. Raise the HDD assembly up at an angle ① as illustrated.
3. Remove the HDD assembly ② from the bay.

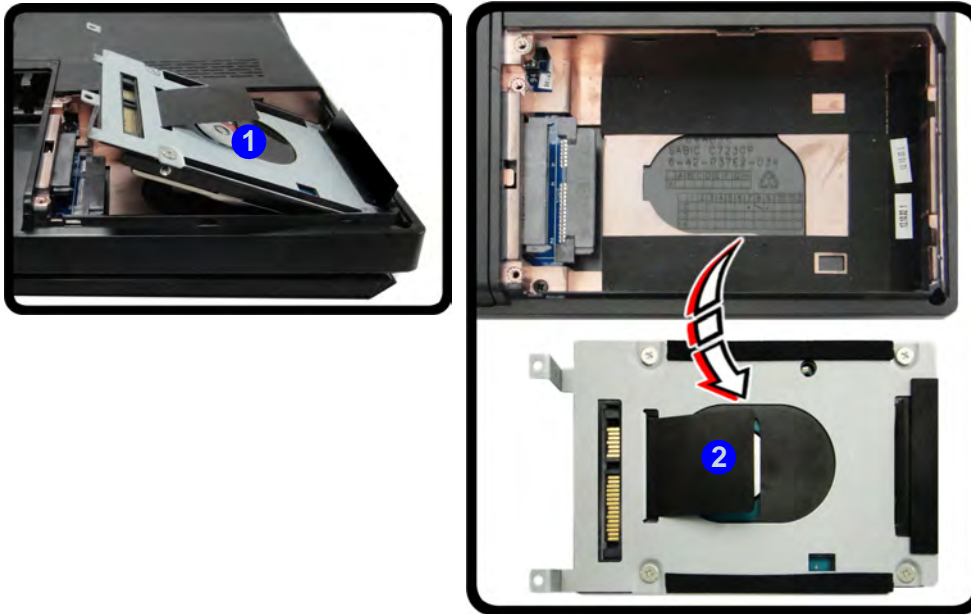
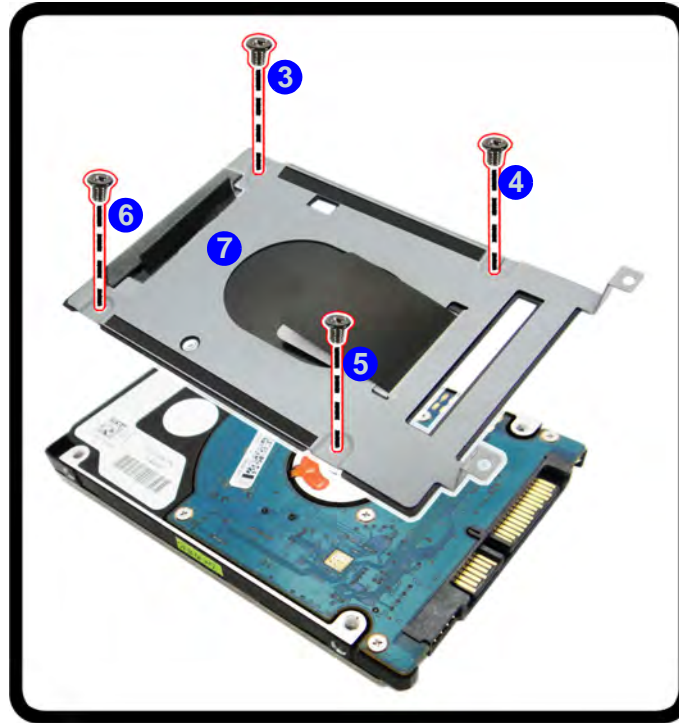

Figure 6 - 9
**Lower Slot Hard
Disk Assembly
Removal**

Upgrading The Computer

4. Remove screws **3** - **6** and separate the hard disk from the insulation plate **7**.
5. Reverse the process to install any new disk (and do not forget to install the insulation plate and screws (see over for cover).

Figure 6 - 10
**Primary Hard Disk
Removal**



Replacing the Hard Disk Drive Bay Cover

1. Reinsert the HDD bay cover by placing it on the bottom case assembly and then slide it on to the case.
2. Make sure the case markers **1** line up before sliding any further.
3. **Press down on the cover** as illustrated **2**, and then slide the cover in the direction of arrow **3**.
4. Replace the screw at point **4**

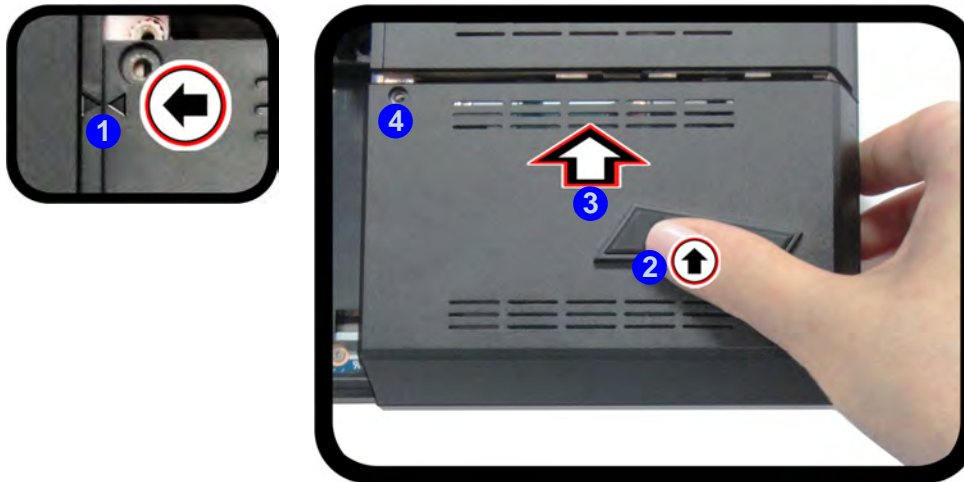

Figure 6 - 11
HDD Bay Cover
Replacement

Upgrading the System Memory (RAM)

The computer has **four** memory sockets for 204 pin Small Outline Dual In-line (SO-DIMM) **DDR III (DDR3)** type memory modules (see *“Memory” on page E - 2*). The total memory size is automatically detected by the POST routine once you turn on your computer.

Two primary memory sockets are located under component bay cover (the bottom case cover), and two secondary memory sockets are located under the keyboard (not user upgradable). If you are installing only two RAM modules then they should be installed in the primary memory sockets under the component bay cover.

Note that the RAM located under the keyboard is not user upgradable. Contact your distributor/supplier for more information if you wish to upgrade the memory in the secondary memory sockets.

Removing the Primary System Memory

1. Turn **off** the computer, and turn it over and remove the battery.
2. Remove screws **1** - **4** from the bottom of the computer.

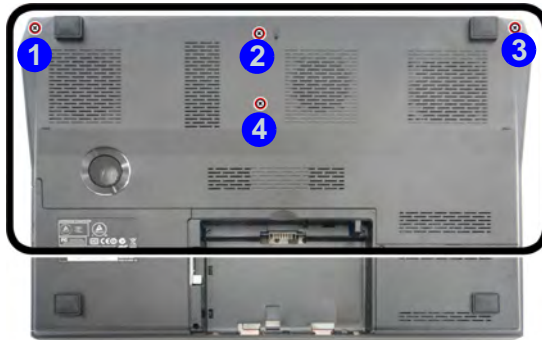

Figure 6 - 12
Component Bay
Cover Screws

3. Slide the component bay cover until the cover and case indicators **5** are aligned.

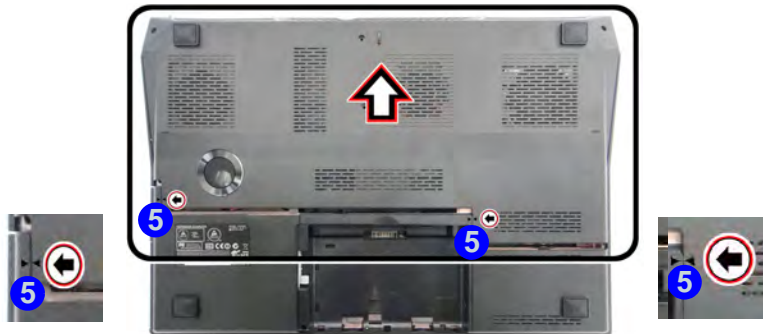

Figure 6 - 13
Component Bay
Cover Move

Upgrading The Computer

- Lift the bottom cover **6** off the computer case.

Figure 6 - 14
**Bottom Cover
Removal**



Contact Warning

Be careful not to touch the metal pins on the module's connecting edge. Even the cleanest hands have oils which can attract particles, and degrade the module's performance.

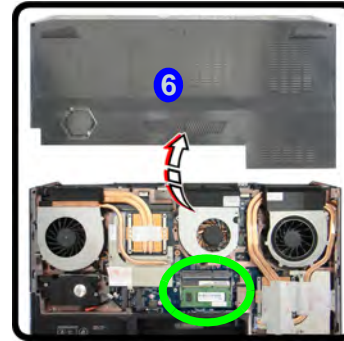

- Gently pull the two release latches (**7** & **8**) on the sides of the memory sockets in the direction indicated below.



Figure 6 - 15
**RAM Module
Release**

- The RAM module **9** will pop-up, and you can remove it.



Figure 6 - 16
**RAM Module
Removal**



Contact Warning

Be careful not to touch the metal pins on the module's connecting edge. Even the cleanest hands have oils which can attract particles, and degrade the module's performance.

- Pull the latches to release the second module if necessary.
- Insert a new module holding it at about a 30° angle and fit the connectors firmly into the memory socket.
- The module's pin alignment will allow it to only fit one way. Make sure the module is seated as far into the socket as it will go. **DO NOT FORCE** the module; it should fit without much pressure.
- Press the module in and down towards the mainboard until the socket levers click into place to secure the module.
- Replace the component bay cover (see over).

Replacing the Component Bay Cover

After the RAM has been installed make sure you replace the component bay cover and all screws.

1. Place the component bay cover on the main computer assembly.
2. Align the markers on the cover and main computer assembly.
3. Slide the cover in position to lock it.
4. Replace the screws.



Figure 6 - 17
**Replacing the
Component Bay
Cover**

Chapter 7: Modules

Overview

This chapter contains information on the various modules (some of which are **optional**) which may come with your computer, depending on the configuration purchased. If you are unsure please contact your service representative.

The chapter includes information on the following:

- Setting Up SATA RAID or AHCI Mode
- PC Camera Module
- Wireless LAN Module
- Fingerprint Reader Module
- Bluetooth & WLAN Combo Module
- Trusted Platform Module
- Sound Blaster Audio
- Intel® Rapid Storage Technology
- Intel® Smart Response Technology
- Intel® Rapid Start Technology Driver



RAID Hard Disks

All hard disks in a RAID should be identical (the same size and brand) in order to prevent unexpected system behavior.

SATA Mode Selection

The SATA mode selection should be made **before installing your operating system**.

DO NOT change your selected SATA mode unless you intend to re-install your operating system. Make sure you have backed up all your data before doing so.

Setting Up SATA RAID or AHCI Mode

AHCI Mode

Advanced Host Controller Interface (AHCI) is an interface specification that allows the storage driver to enable advanced serial ATA features such as Native Command Queuing (for maximum hard disk efficiency and performance). AHCI mode can be supported by one or two hard disks. Make sure you install the **Intel® Rapid Storage Technology** application if you have set up your hard disk(s) in AHCI mode (see *“Intel® Rapid Storage Technology” on page 7 - 86*)

RAID

To configure your RAID (Redundant Array of Independent Disks) system in Striping (RAID 0), Mirroring (RAID 1) or Recovery modes (see *Table 7 - 1, on page 7 - 3*) you will require **at least two identical** (see sidebar) hard disks. Note that you will need to install a driver from the *Device Drivers & Utilities + User’s Manual disc* at OS installation (see *page 7 - 4*).

Intel® Rapid Storage Technology Application

Make sure you install the **Intel® Rapid Storage Technology** application if you have set up your hard disk(s) in RAID mode (see *“Intel® Rapid Storage Technology” on page 7 - 86*).

| RAID Level | Description |
|------------|---|
| RAID 0 | Identical drives reading and writing data in parallel to increase performance . RAID 0 implements a striped disk array and the data is broken into blocks and each block is written to a separate disk drive. |
| RAID 1 | Identical drives in a mirrored configuration used to protect data . Should a drive that is part of a mirrored array fail, the mirrored drive (which contains identical data) will handle all the data. When a new replacement drive is installed, data to the new drive is rebuilt from the mirrored drive to restore fault tolerance. |
| Recovery | Two identical drives copying data between a master and a recovery disk. This provides more control over how data is copied between the master and recovery drives, fast volume updates and the ability to view the data in <i>Windows Explorer</i> . |

Table 7 - 1
RAID Levels



Array Types

A **Mirrored Array (RAID 1)** provides full data protection, as data can simply be copied from a healthy disk to a replacement for any failed disk.

A **Striped Array (RAID 0)** is **NOT** fault-tolerant. The failure of one drive will result in the loss of all data in the array. It is designed to increase disk performance by spreading the I/O load across the channels and drives.



SATA Mode Selection

The SATA mode selection should be made **before installing your operating system**.

DO NOT change your selected SATA mode unless you intend to reinstall your operating system. Make sure you have backed up all your data before doing so.

RAID Hard Disks

All hard disks in a RAID should be identical (the same size and brand) in order to prevent unexpected system behavior.

SATA RAID Setup Procedure (Windows 8)

To configure your RAID (Redundant Array of Independent Disks) system in Striping (RAID 0) or Mirroring (RAID 1) modes (see *Table 7 - 1, on page 7 - 3*) you will require **at least two identical** (see sidebar) hard disks.

You need to setup a RAID before installing your *Windows 8* operating system, and you will need to prepare the following in order to do so.

1. The *Microsoft Windows 8 OS DVD*.
2. A hard disk installed in the Primary HDD bay.
3. A **second** (identical) hard disk installed in the Secondary HDD bay.
4. The *Device Drivers & Utilities + User's Manual* disc.
5. A USB flash drive.
6. An operable computer (to copy files from the *Device Drivers & Utilities + User's Manual* disc to the USB flash drive).

Before setting up the system you will need to copy a driver folder to a USB flash drive or external USB hard disk. This driver folder is included on the *Device Drivers & Utilities + User's Manual disc* but you will need to go to an operable computer and copy the folder to a USB Flash drive or external USB hard disk.

Note that the following setup procedure is for clean systems only (i.e. the system **has not** been previously setup in IDE/AHCI modes and is being changed to a RAID system). If you are changing your system to RAID after having previously setup in another mode see *“Changing The SATA Mode” on page 8 - 14*.

1. Go to the operable computer and insert a USB Flash drive or external USB HDD.
 2. Insert the **Device Drivers & Utilities + User’s Manual** disc into the CD/DVD drive of the operable computer.
 3. Copy the **f6flpy-x64** folder from the location below (D: denotes your DVD drive) on the **Device Drivers & Utilities + User’s Manual** disc to the USB flash drive or external USB hard disk.
- **Windows 8 64bit = D:\Options\00_IRST\f6flpy\f6flpy-x64**
4. Start-up your notebook computer and press <F2> to enter the **BIOS**.
 5. Go to the **Boot** menu, select **UEFI Setting** and press <Enter> (see page 5 - 17).
 6. Set **UEFI Boot** to “**Enabled**”.
 7. Press <Esc> to exit the menu and go to the **Advanced** menu.
 8. Select **SATA Mode** (see page 5 - 10), press <Enter> and select “**RAID Mode**”.
 9. Press <F4> and <Yes> to “**Save Changes and Reset**”.
 10. After computer restarts press <F2> to enter the **BIOS** again.
 11. Go to **Intel(R) Rapid Storage Technology** (in the **Advanced** menu) and press <Enter>.
 12. Select **Create RAID Volume** and press <Enter>.

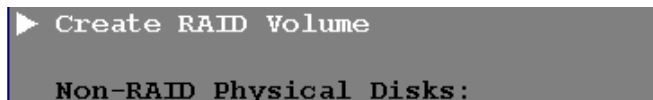
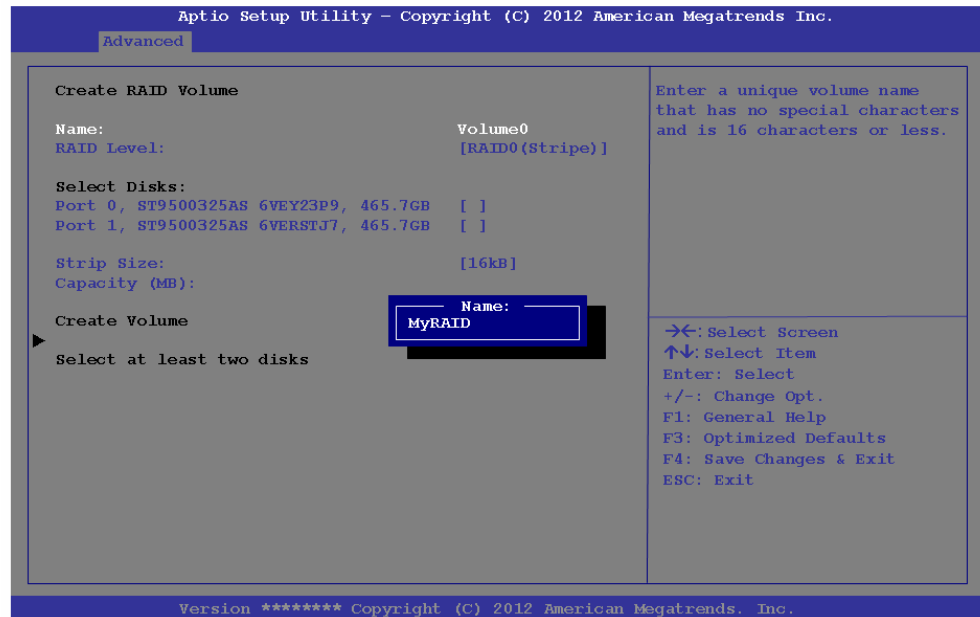

Figure 7 - 1
Create RAID Volume
(Advanced > Intel(R)
Rapid Storage
Technology)

Modules

13. You can now setup your RAID volume using any two installed disks.
14. Go to **Name:** and press <Enter>.
15. Type a name of your choice for your RAID volume and press <Enter>.



7

Figure 7 - 2
Name the RAID
Volume (Advanced
> Intel(R) Rapid
Storage
Technology)

16. Go to **RAID Level:** and press <Enter>.
17. Choose the RAID Level required (see [Table 7 - 1, on page 7 - 3](#) for details) and press <Enter>.
 - **RAID0 (Stripe)**
 - **RAID1 (Mirror)**
 - **Recovery**
18. Go to any of the disks listed under **Select Disks:** and select a disk name and press <Enter>.
19. Move the cursor down (use the arrow keys) onto to **X** (o select the disk required and press <Enter>).
- If you have selected a **Recovery** level RAID then you need to select one disk to be **Master disk (M)** and one disk to be the **Recovery disk (R)**

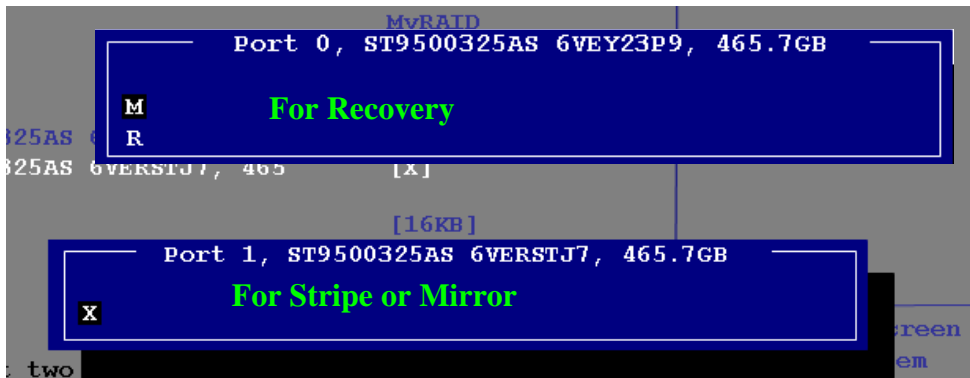

Figure 7 - 3
Select Disks
(Advanced > Intel(R)
Rapid Storage
Technology)

Modules

20. You should select two identical disks to form your RAID volume.
21. If you have selected **RAID0 (Stripe)** then you can adjust the “**Strip Size**” to your requirements.
22. If you have selected **Recovery** then you can adjust the **Synchronization** to “**On Request**” or “**Continuous**”.
23. Go to **Create Volume** and press <Enter>.
24. The RAID volume will then be created and the RAID information will be displayed under **Intel(R) Rapid Storage Technology** (in the **Advanced** menu).

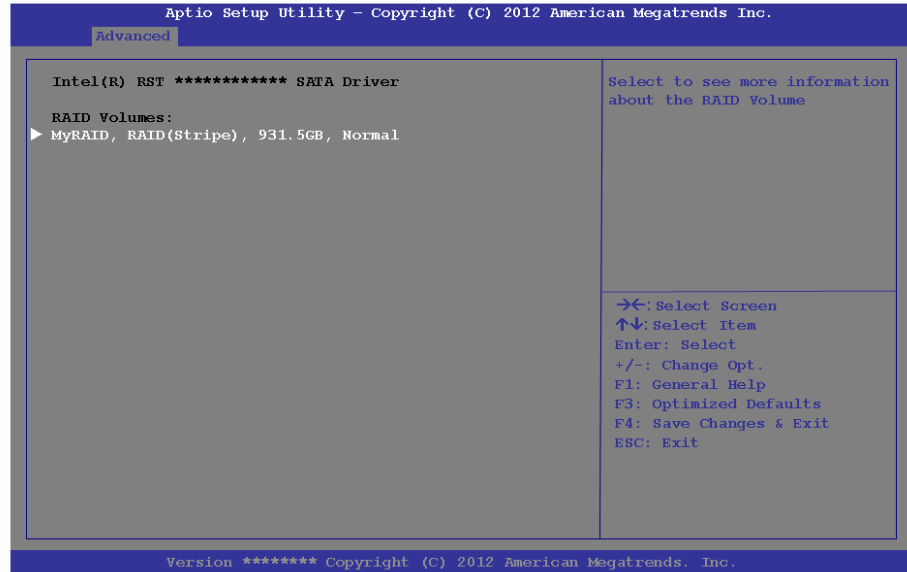

Figure 7 - 4
**Created RAID
Information
(Advanced > Intel(R)
Rapid Storage
Technology)**

25. Press <Esc> to exit the menu.
26. Press <F4> and <Yes> to “**Save Changes and Reset**”, however **ensure that the two conditions in the bulleted points below are met** before doing so.
 - Make sure the *Windows 8* OS DVD is in the DVD drive, as the computer starts up it will automatically boot from the *Windows 8* OS DVD (you will be prompted to press a key to boot from the DVD).
 - Make sure your USB Flash drive or external USB hard disk is attached to one of the USB ports on the computer.
27. Press <F7> as the computer starts up to bring up the boot device menu.
28. Select the DVD drive containing the *Windows 8* OS DVD and press <Enter>.
29. Press a key at system startup to begin installing *Windows* from your *Microsoft Windows 8* disc.
30. Click **Next > Install Now** to continue installing the operating system as normal (see your *Windows* documentation if you need help on installing the *Windows* OS).
31. A prompt will appear to ask you to **Load Driver**.
32. Click **Browse** and browse to the location you copied the files to on your USB Flash drive or external USB hard disk (X: denotes your USB Flash drive or external USB hard disk):
 - **X:\f6flpy-x64 (Windows 8 64bit)**
33. Click **Next**.
34. Follow the on-screen instructions to install the *Windows 8* operating system.

35. Install the **Windows** drivers from the **Device Drivers & Utilities + User's Manual** disc as per **Table 4 - 1, on page 4 - 3** (make sure you install the Intel Rapid Storage Technology driver - see overleaf).
36. Run the **Intel® Rapid Storage Technology** application to manage your RAID volume as instructed in **"Intel® Rapid Storage Technology for RAID Systems" on page 7 - 87**.

IRST Driver Installation

1. Insert the **Device Drivers & Utilities + User's Manual** disc into the DVD drive.
2. Click **Option Drivers** (button).
3. Click **6.Install IRST Driver > Yes**.
4. Click **Next > Next**.
5. Click the tickbox to accept the license and click **Next**.
6. Click **Next > Next > Next**.
7. Click **Finish** to restart the computer.
8. See **"Intel® Rapid Storage Technology for RAID Systems" on page 7 - 87**.

Deleting a RAID (Windows 8)

If you wish to delete an existing RAID then follow the procedure below to do so. However **backup up any necessary files and data before deleting a RAID**, as doing so will result in the loss of all data on the RAID volumes.

1. Start-up your notebook computer and press <F2> to enter the **BIOS**.
2. Go to **Intel(R) Rapid Storage Technology** (in the **Advanced** menu) and press <Enter>.
3. Go to the RAID (listed under **RAID Volumes:**) and press <Enter>.
4. Select **Delete** and press <Enter>.
5. Select **“Yes”** (note that all the data on the volumes will be lost) and press <Enter>.

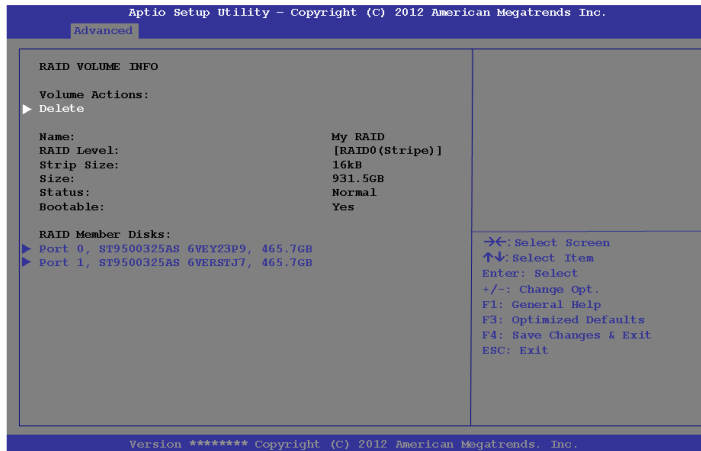

Figure 7 - 5
Delete RAID
(Advanced > Intel(R)
Rapid Storage
Technology)

PC Camera Module

When the PC Camera application is run the LED indicator to the left of the camera will be illuminated in **red**. Note that you need to use the **Camera** app in *Windows 8* to take pictures and capture video. **Use the Fn + F10 key combination** (see *“Function Keys & Visual Indicators” on page 1 - 19*) **to toggle power to the PC Camera module.**

Note that the **Model B** computers may feature a 5.0M Pixels / 1.0M HD dual camera system. When the LCD is open, the camera facing you is the 1.0M HD camera (see *Figure 1 - 3 on page 1 - 8*). The 5.0M Pixels camera is located on the top case, which will be facing away from you when the LCD panel is open (see *Figure 1 - 4 on page 1 - 9*).

PC Camera Audio Setup

If you want to capture video & **audio** with your camera, it is necessary to setup the audio recording options in *Windows*.

1. Go to the **Control Panel**.
2. Click **Sound**  (**Hardware and Sound**) and click **Recording** (tab).
3. Right-click hold and release **Microphone** (Realtek High Definition Audio) and make sure the item is not disabled.
4. Double-click **Microphone** (or select **Properties** from the right-click menu).
5. Click **Levels** (tab), and adjust the **Microphone** and **Microphone Boost** sliders to the level required.
6. Click **OK** and close the control panels.

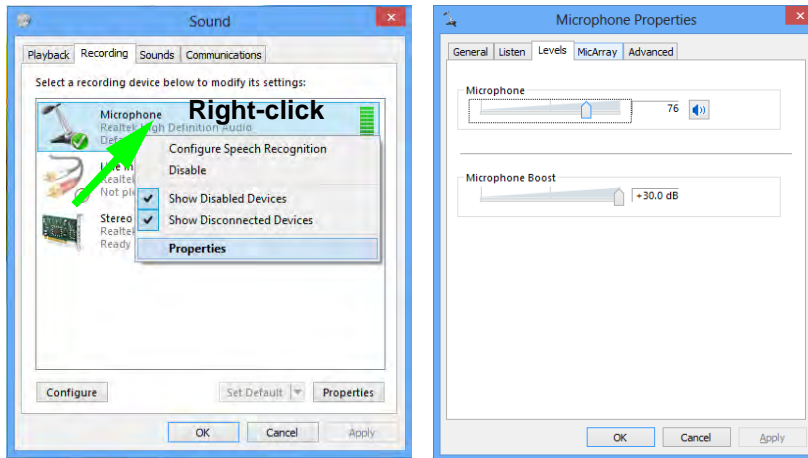

Figure 7 - 6
Audio Setup for PC
Camera

Camera App



1. Make sure the camera is powered on (use the **Fn + F10** key combination to toggle power to the camera module).
2. Click the **Camera** app icon in the **Start screen** to run the **Camera** app .
3. The camera interface is a translucent app bar with three buttons (**Model B** computers feature a **Change camera** button that enables the camera to be switched between the 5.0M Pixels and 1.0M HD dual cameras.

Figure 7 - 7
Camera App Bar

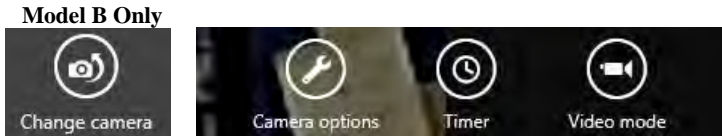

- **Camera options:** Click this button to open a window with three main options:

Camera Options

- **Resolution** (determined by the camera spec)
- **Audio device** (select microphone to use)
- **Video Stabilization** (a toggle based on spec of the camera)

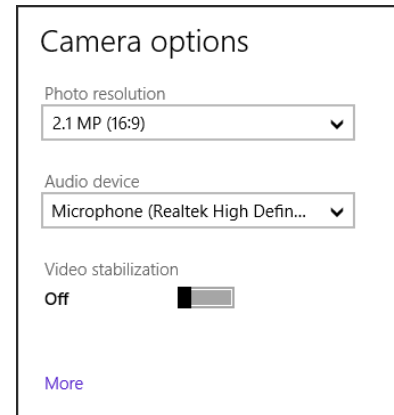
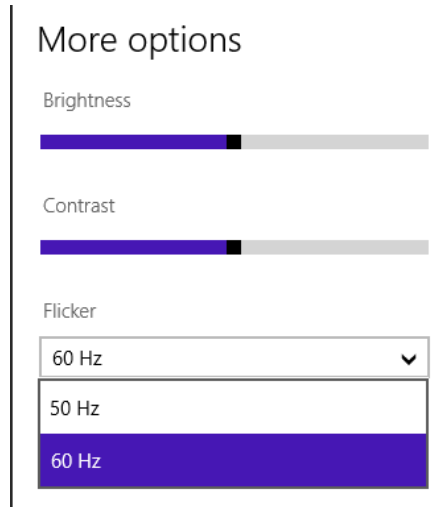



Figure 7 - 8
Camera Options

You can also click on **More** to adjust **Brightness**, **Contrast** and **Flicker** (if you find that the video screen in the camera program is flickering, you can try to adjust the setting here).



- **Timer:** This button will start a three second countdown before the system takes a still photo or video recording starts.
- **Video Mode:** This button toggles between still photo mode (transparent button ) and video recording mode (highlighted white button ) .



Eliminating Screen Flicker

If you find that the video screen in the camera program is flickering, you can try to adjust the setting in **Flicker** under **More Options**.

Figure 7 - 9
More Camera Options

Taking Pictures/Capturing Video

1. Make sure the camera is powered on (use the **Fn + F10** key combination to toggle power to the camera module).
2. Click the **Camera** app icon in the **Start screen** to run the **Camera** app .
3. Click to select the timer if you require a countdown before capture.
4. Click to select either photo or video modes.
5. Click in the main window to take a picture or start video capture (if video capture begins a timer will appear in the bottom right corner of the screen).
6. To stop video capture click the main window again.
7. Captured photos and videos will be saved to a **Camera Roll** folder within the **Picture** folder in **Libraries**.

7

Figure 7 - 10
Libraries - Pictures

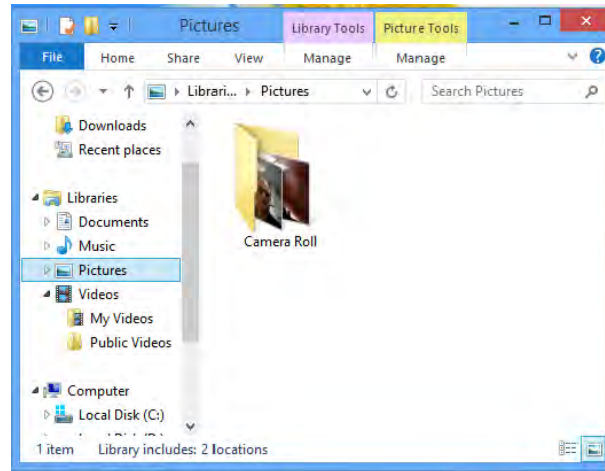

8. A scroll arrow will appear on the left side of the screen after any pictures/videos have been captured.
9. Click the arrows (on either side of the screen) to browse through the captured photos/video, and back to the Camera app.
10. Clicking on a captured photo will bring up an app bar with **Crop** and **Delete** buttons.



Figure 7 - 11
Crop & Delete
Buttons
 (for Still Photos)

11. Use the handles to **Crop** any captured picture, and click **OK** to save the changes made.
12. Click **Delete** to delete any captured photo (note that no prompt will appear to confirm the delete).
13. Right-click any captured video to bring up app bar with **Trim** and **Delete** buttons.



Figure 7 - 12
Trim & Delete
Buttons
 (for Video Files)

14. Use the buttons at either end of the slider to adjust the video length and click **OK** to save the changes made.

Reducing Video File Size

Note that capturing high resolution video files requires a substantial amount of disk space for each file. After recording video, check the video file size (right-click the file and select **Properties**) and the remaining free space on your hard disk (go to **My Computer**, right-click the hard disk, and select **Properties**). If necessary you can remove the recorded video file to a removable medium e.g. CD, DVD or USB Flash drive.

Note that the *Windows 8* system requires a minimum of **16GB (32-bit)** or **20GB (64-bit)** of free space on the **C: drive** system partition. In order to prevent system problems it is recommended that you move any large sized captured video file to a location other than the **C: drive**, or reduce video resolution (see below).

To Reduce Video Resolution Output Size:

1. Run the **Camera** app.
2. Click the **Video resolution** dropdown and select a lower resolution size in order to reduce the captured file size.
3. Note that reducing video resolution will affect the video quality.

Wireless LAN Module

If you have included an **Intel®**, **3rd Party 802.11b/g/n** or **Qualcomm Atheros WLAN (Combo) module** is on (i.e. the system is not in **Airplane Mode**) before installing the driver.

Make sure you install the drivers in the order indicated in *Table 4 - 1, on page 4 - 3*.

Note that you need to install both the WLAN & Bluetooth drivers for the WLAN & Bluetooth Combo modules, however the Qualcomm Atheros WLAN (Combo) module only requires the WLAN driver installation.

See the appropriate driver installation instructions on the page indicated below:

- See *“3rd Party 802.11b/g/n Driver Installation” on page 7 - 20*.
- See *“Intel® WLAN Driver Installation” on page 7 - 20*.
- See *“Qualcomm Atheros WLAN Combo Driver Installation” on page 7 - 21*.



Wireless Device Operation Aboard Aircraft

The use of any portable electronic transmission devices aboard aircraft is usually prohibited. Make sure the **WLAN & Bluetooth module(s) are OFF** if you are using the computer aboard aircraft by putting the system in to **Airplane Mode** (see *Table 1 - 6, on page 1 - 19*).

3rd Party 802.11b/g/n Driver Installation

1. **Make sure the system is not in Airplane Mode**, and then insert the *Device Drivers & Utilities + User's Manual* disc into the DVD drive.
2. Click **Option Drivers** (button).
3. Click **1.Install WLAN Driver > Yes**.
4. Click **Next**.
5. Click **Finish** to restart the computer.
6. The operating system is the default setting for Wireless LAN control in *Windows* (see page [7 - 28](#)).

Intel® WLAN Driver Installation

1. **Make sure the system is not in Airplane Mode**, and then insert the *Device Drivers & Utilities + User's Manual* disc into the DVD drive.
2. Click **Option Drivers** (button).
3. Click **1.Install WLAN Driver > Yes**.
4. Click in the tickbox to agree to the **End User License Agreement** and click **Install**.
5. Click **Finish**.
6. The operating system is the default setting for Wireless LAN control in *Windows* (see page [7 - 28](#)).

Qualcomm Atheros WLAN Combo Driver Installation

1. **Make sure the system is not in Airplane Mode**, and then insert the *Device Drivers & Utilities + User's Manual* disc into the DVD drive.
2. Click **Option Drivers** (button).
3. Click **1.Install WLAN Driver > Yes**.
4. Click **Next > Yes > Next**.
5. Click **Install**.
6. Click **Yes** to restart the computer.
7. The operating system is the default setting for Wireless LAN control in *Windows* (see page [7 - 28](#)), and *“Bluetooth Configuration in Windows 8” on page 7 - 59* (note that no Bluetooth driver is required for this module).
8. See *“Qualcomm Atheros Killer Network Manager” on page 7 - 22* for details of the application.



Killer Network Manager

The Killer Network Manager allows you to:

View system information, performance and network activity.

Monitor network traffic bandwidth and priorities.

View and control applications using the network.

Optimize the network bandwidth and configure settings.

Qualcomm Atheros Killer Network Manager

You can use the **Qualcomm Atheros Killer Network Manager** to monitor your network connection (use the method outlined on page 7 - 28 to connect to a WLAN access point).

1. Go to the **Qualcomm Atheros Killer Network Manager** by double-clicking the icon  in the **Start** screen or on the **desktop** app.
2. Click any of the menu headings on the left to access the menu:

Overview

The **Overview** window allows you view the system information, network connection status and a summary of applications using bandwidth.



Figure 7 - 13
Killer Network Manager - Overview

PC Monitor

The **PC Monitor** logs performance information on the computer. Use the drop-down menu to select Processor, Memory, FPS (frames per second), Wireless Signal Strength and Internet Bandwidth. You can click on the graph to display the time and measurement at that point.

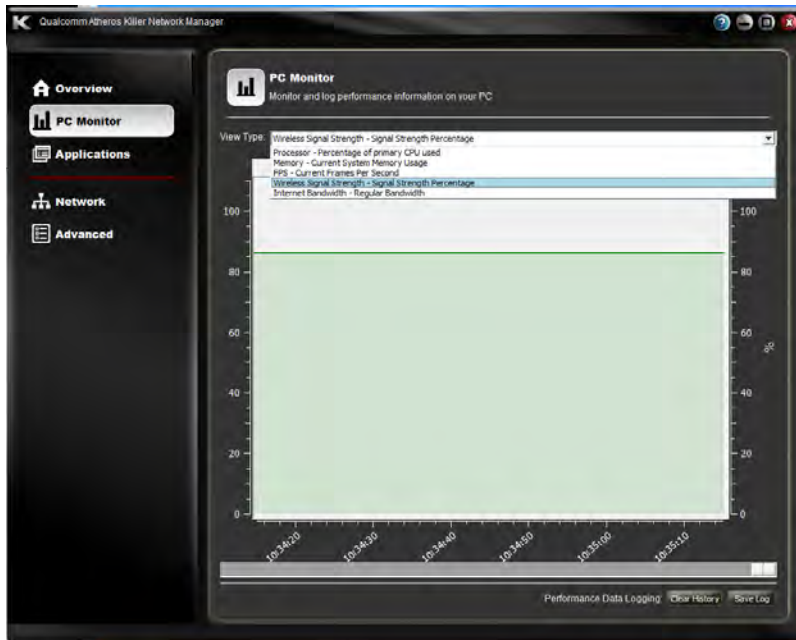

7

Figure 7 - 14
**Killer Network
 Manager - PC
 Monitor
 (Wireless Signal
 Strength)**



Changing Application Bandwidth

To change the Upload or Download bandwidth position your cursor over the arrow on the right side of the bar. Click and drag the icon to adjust the setting. This will now limit internet traffic for the application to this speed.

Applications

The **Applications** window allows you to view network applications and prioritize how each one uses any available bandwidth. The numbers to the left indicate the current priority level for the application, from **1 - highest to 4 - lowest**. Click in an application to expand the item, and click the number to change the priority level, or click **Allow/Block** to change the status.

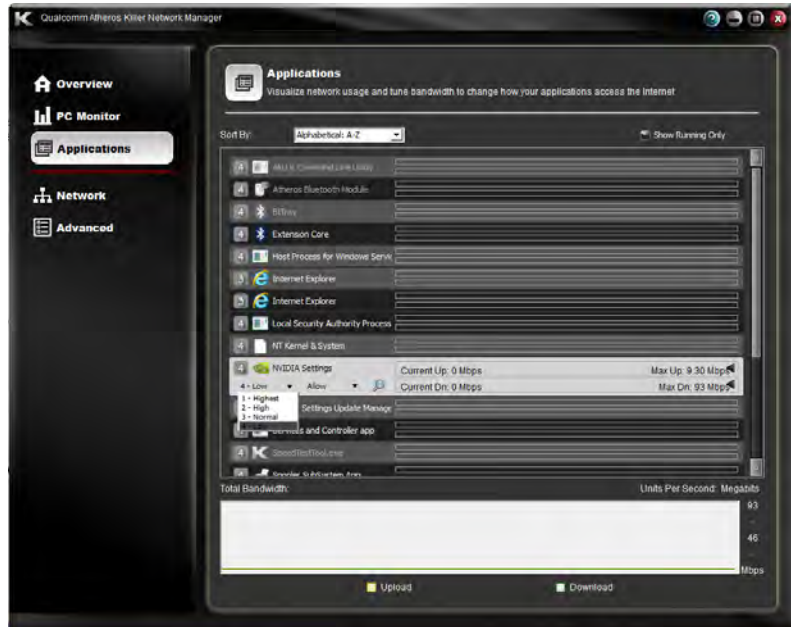

Figure 7 - 15
Killer Network Manager - Applications

Network

Configure the network connection settings and internet provider bandwidth speed from the **Network** window. Click **Test** to run a test of your bandwidth, and when complete use the results to configure the optimal upload and download bandwidth for the Killer Network Manager (these are the maximum values displayed in Applications).

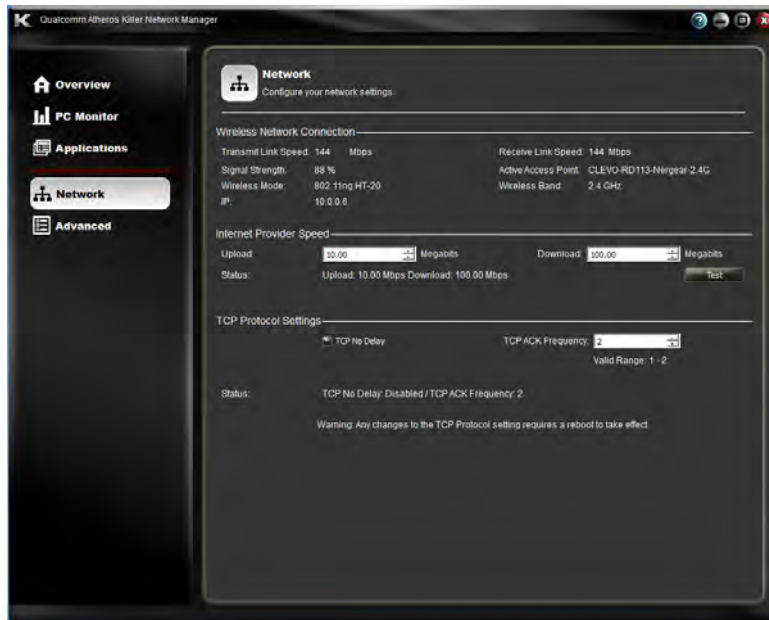



Figure 7 - 16
**Killer Network
Manager - Network**

Modules

Help



To access the **Help** menus click the icon  at the top right of the application. Click **Table of Contents** to display the menu.

Advanced

Customize Killer Network Manager features from the **Advanced** window. Here you can change items displayed in Overview, configure default settings for Applications and features such as updates, closing dialog, bandwidth units displayed and performance statistics.

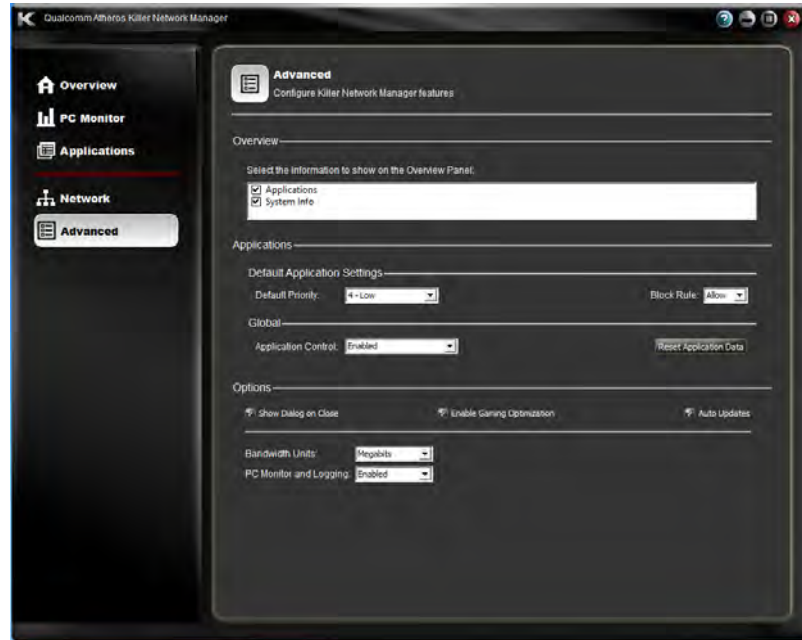



Figure 7 - 17
**Killer Network
Manager - Advanced**

Quitting Killer Network Manager

Clicking the close  icon simply minimizes the application to the system tray, and it will continue to run in the background. To quit the application **right-click** the icon in the system tray and select **Quit** from the menu.

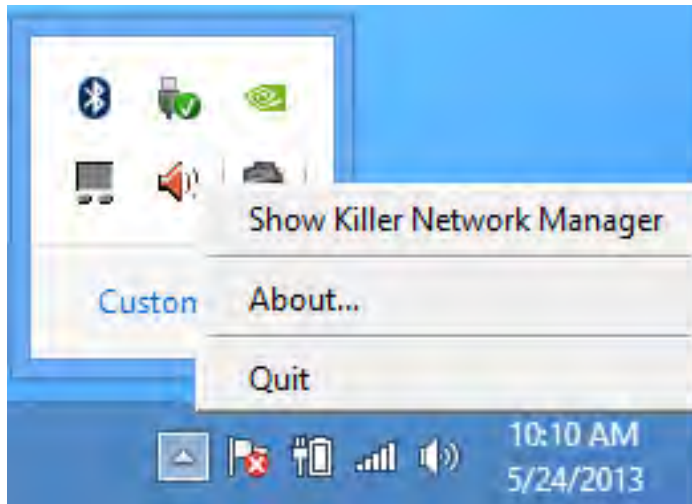

Figure 7 - 18
**Killer Network
Manager - Quit**

WLAN Configuration in Windows 8



You can configure a wireless connection using one of the following options, however make sure the Wireless LAN module is turned on (and not in Airplane Mode) before configuration begins.

Charms Bar

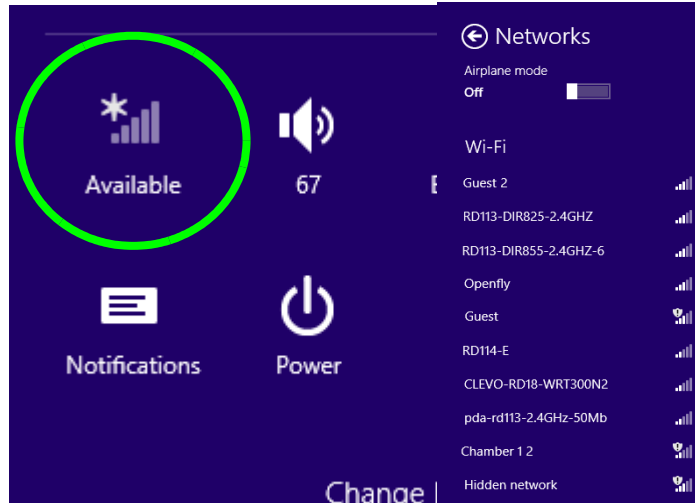
1. Go to the **Charms Bar**.
2. Select **Settings** and then click the **WiFi icon** (it should read **Available** under the icon and **Airplane mode** should be **Off**).
3. A list of available access points will appear.



7
Figure 7 - 19
**WiFi Settings
(Charms Bar) &
Networks**

4. Double-click an access point to connect to it (or click it and click **Connect**).
5. Enter a network security key (password) if required, and click **Next**.
6. You can choose to share or connect to devices or not.
7. When you are connected to the network access point it will display the Connected icon .
8. Select any connected network and click **Disconnect**  to disconnect from a connected access point.

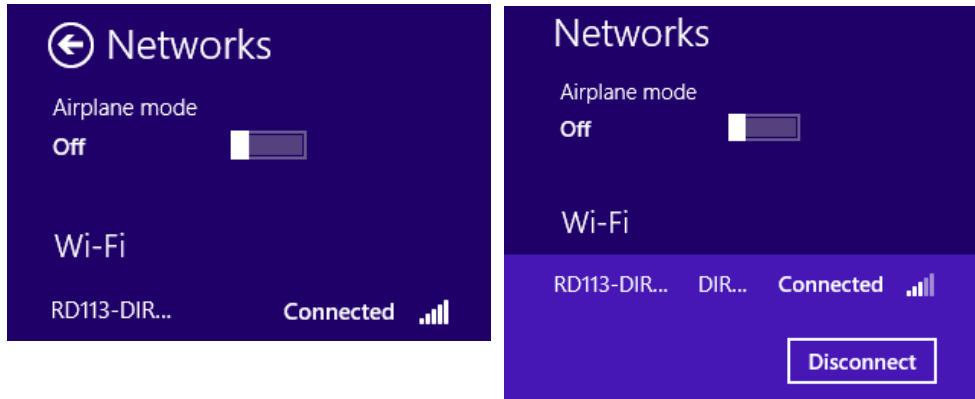
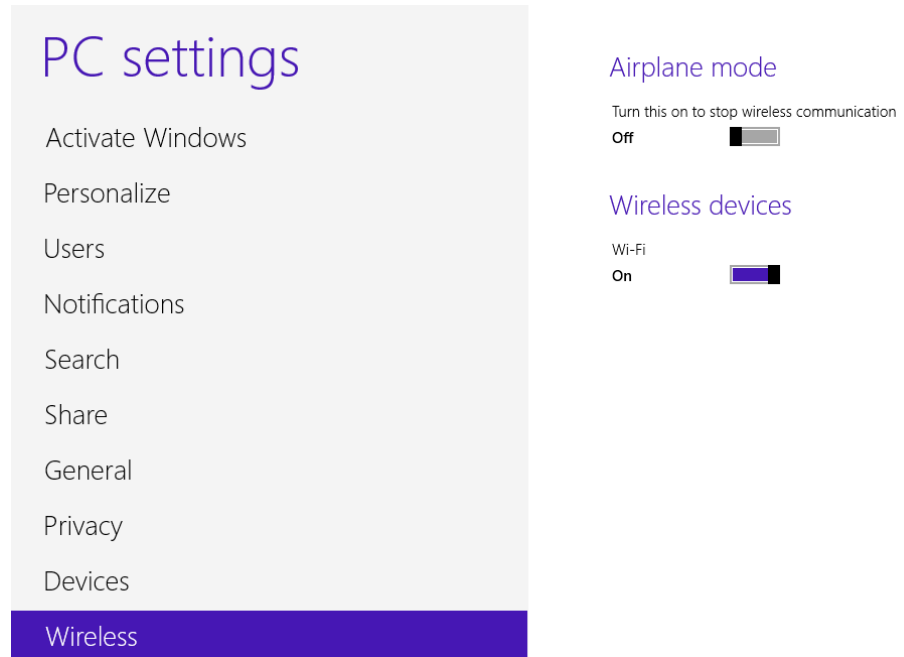

Figure 7 - 20
Networks
Connected /
Disconnect



9. You can click the **Airplane Mode** button to turn the mode On or Off.
10. If you click on **Change PC Settings** (at the bottom of **Settings** in the **Charms Bar**) you can turn **Wireless** or **Airplane Mode** On/Off (see over).

11. You need to either use **Airplane Mode**, or to **turn the WLAN module off** aboard aircraft.

Figure 7 - 21
PC Settings
(Wireless)



Desktop Mode

1. Switch to the Windows Desktop (click the app or use the Windows logo key  + **D** key combination).
2. Click the wireless icon  in the notification area of the taskbar.
3. A list of available access points will appear.
4. Double-click an access point to connect to it (or click it and click **Connect**).
5. Enter a network security key (password) if required, and click **Next**.
6. You can choose to share or connect to devices or not.
7. Select any connected network and click **Disconnect** to disconnect from a connected access point.

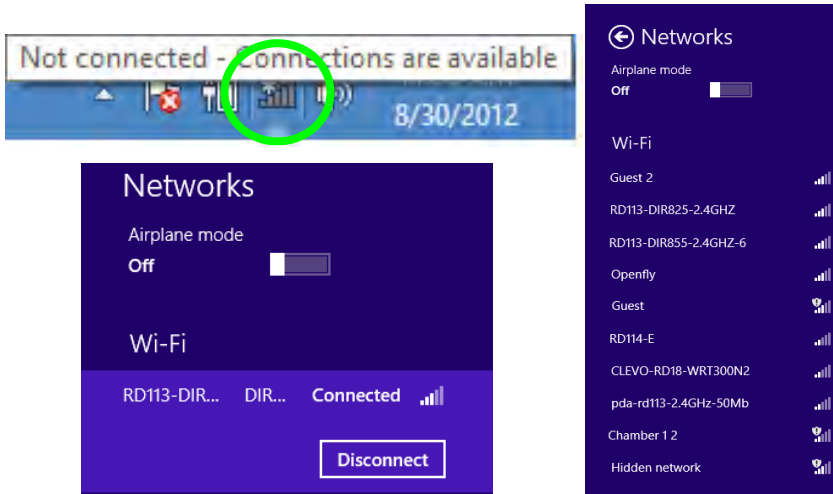

Figure 7 - 22
Windows Desktop
Taskbar Notification
Area WLAN
Connection

Control Panel

If you are in **Category View** do the following (see over for Icon View):

1. Open the **Control Panel**.
2. Click the **Network and Internet** control panel.
3. Click **Connect to a network**.

Figure 7 - 23
Network and Internet Control Panel

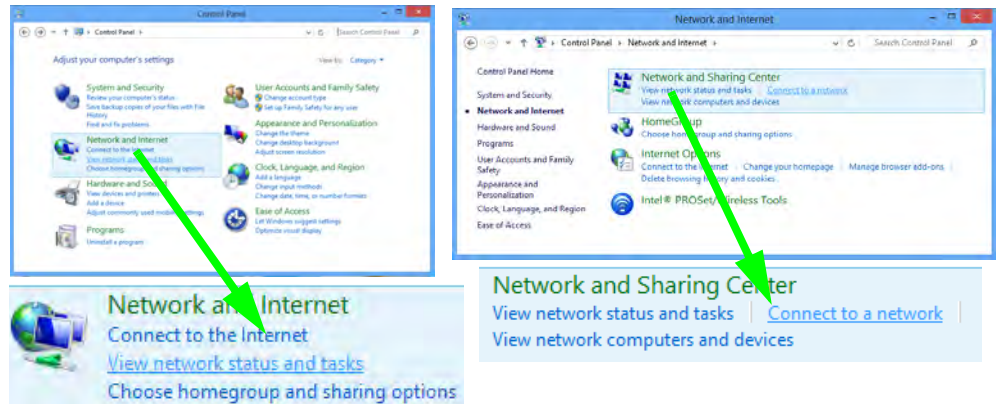

4. A list of available access points will appear.
5. Double-click an access point to connect to it (or click it and click **Connect**).
6. Enter a network security key (password) if required, and click **Next**.
7. You can choose to share or connect to devices or not.
8. Select any connected network and click **Disconnect** to disconnect from a connected access point.

If you are in **Icon View** do the following:

1. Open the **Control Panel**.
2. Click **Network and Sharing Center**.
3. Click **Change Adapter Settings**.
4. Double-click **Wi-Fi**.

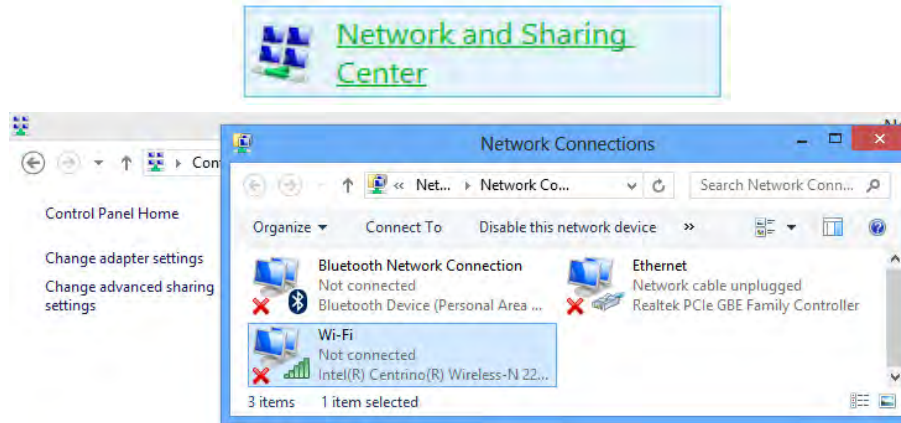

Figure 7 - 24
Network and
Sharing Center
Control Panel

5. A list of available access points will appear.
6. Double-click an access point to connect to it (or click it and click **Connect**).
7. Enter a network security key (password) if required, and click **Next**.
8. You can choose to share or connect to devices or not.
9. Select any connected network and click **Disconnect** to disconnect from a connected access point.



Password Warning

If you set passwords for any of the security modules, **NEVER** forget your password.

The consequences of this could be serious. If you cannot remember your boot password you must contact your vendor and you may lose all of the information on your hard disk.

Fingerprint Reader Module

The fingerprint reader module provides a high level of security for your computer. Make sure you have administrator's rights to your computer, and have a **Windows** password enabled for full security protection.

The **fingerprint reader** and application software allow you to:

- Access or Lock your computer
- Protect sensitive files
- Display and file your favorite web pages

If you have included the fingerprint reader in your purchase option you will need to install the driver as per the instructions provided. Make sure you have administrator's rights to your computer, and have a **Windows** password enabled for full security protection. Before beginning the enrollment process it is recommended that you go through the fingerprint tutorial.

There are **two fingerprint applications** supplied with this model. Install the driver from the *Device Drivers & Utilities + User's Manual* disc and follow the appropriate instructions on the following pages.

- See overleaf for driver installation on the two applications.
- See pages [7 - 37](#) to [7 - 45](#) for information on the **Protector Suite** application.
- See pages [7 - 46](#) to [7 - 56](#) for information on the **BioExcess** application.

Protector Suite Fingerprint Reader Driver Installation

1. Insert the *Device Drivers & Utilities + User's Manual* disc into the DVD drive.
2. Click **Option Drivers**.
3. Click **2.Install FingerPrint Driver > Yes**.
4. Click **Next > Next > Next**.
5. Click **Finish > Yes** to restart the computer.
6. After installing the driver you will need to install **Microsoft.net Framework (V3.5 or higher)** before running the Protector Suite application. You can go to the Microsoft website, search for the file, download it and then install it, or alternatively you can **enable Microsoft.net Framework from the control panel** by following the procedure overleaf.
7. See "*Protector Suite Application*" on page 7 - 37 for more information.

BioExcess Fingerprint Reader Driver Installation

1. Insert the *Device Drivers & Utilities + User's Manual* disc into the CD/DVD drive.
2. Click **Option Drivers**.
3. Click **2.Install Fingerprint Driver > Yes**.
4. Click **Next** (the system will take some time to install the application).
5. Click **Finish** to restart the computer.
6. See "*BioExcess Application*" on page 7 - 46 for more information.

Protector Suite Application

Before running the **Protector Suite** application you will need to **enable .NET Framework 3.5**.

Enabling the .NET Framework 3.5 in the Windows Control Panel

1. Make sure you have a working internet connection.
2. Go to the Control Panel.
3. Click to select **Programs and Features (Programs)**.
4. Click **Turn Windows features on or off** (in the menu on the left).
5. Click to select the **.NET Framework 3.5 (includes .NET 2.0 and 3.0)** check box (the sub menu items are not required).

Figure 7 - 25
Turn Windows
Features On or Off

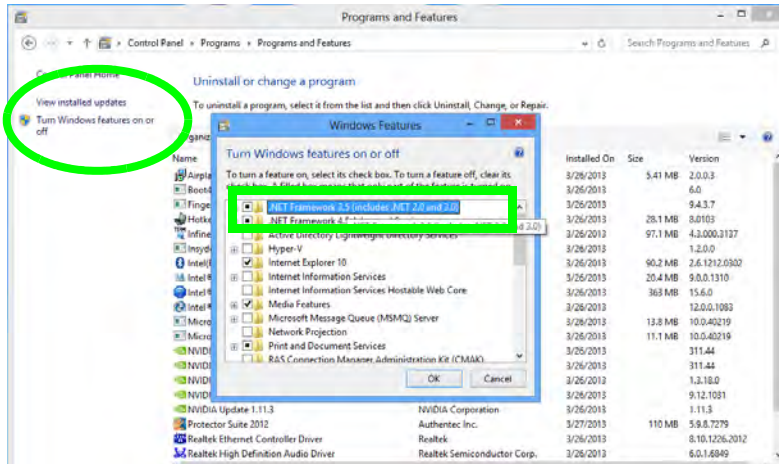

Modules

6. Click **OK** to install the features required.
7. **Windows** will search for (as long as you have a working internet connection) and install the features.
8. Click **Restart now** to complete the installation.

Figure 7 - 26
Windows Features
(Restart now)

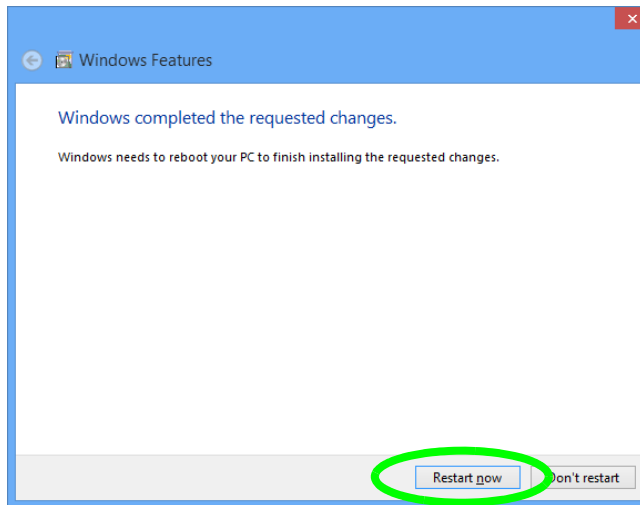

Protector Suite - User Enrollment

1. Run the **Control Center** from the **Start** screen, or double click the notification area icon  (click **Initialize**).
2. On the first run of the program you will be asked to click the **Accept** button to accept the license.
3. If you have not set a **Windows** password you will be prompted to do so (**note**: If you have not set a password **Protector Suite** cannot secure access to your computer).
4. Click **Submit** when you have entered password.
5. You will then be prompted to enroll your fingerprints.
6. Click the button above any of the fingers to begin the enrollment process for that finger (click **Tutorial** to get help with fingerprint enrollment at any time - see over).

Fingerprint Enrollment

Note that it is strongly recommended that you enroll more than one finger in case of injury etc.

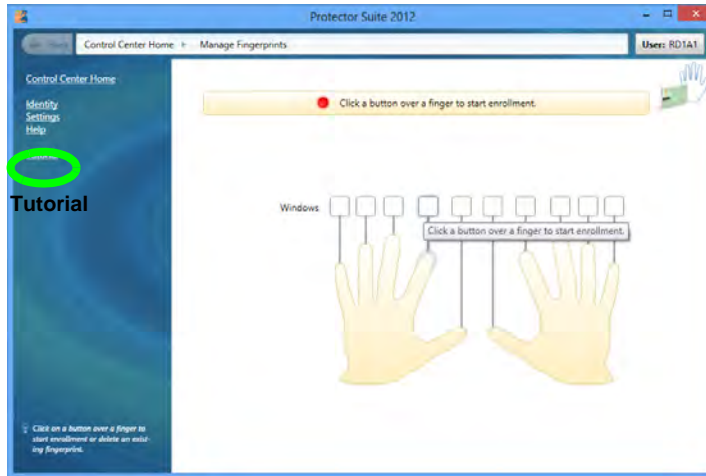
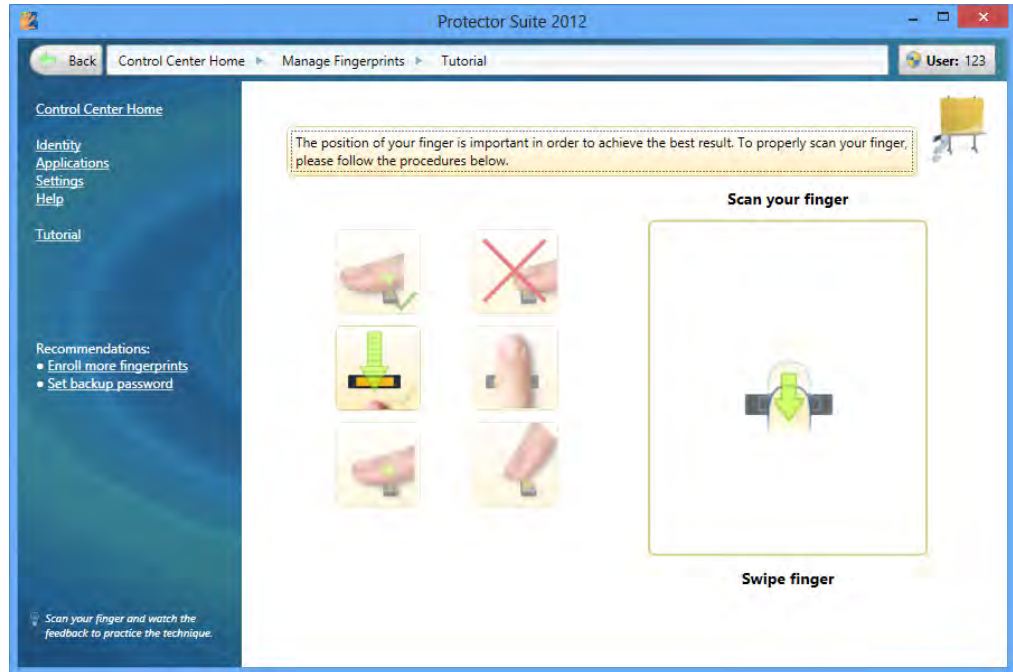

Figure 7 - 27
Fingerprint Enrollment
(Click Finger to Enroll)

- Put the finger **flat in the center of the reader** until prompted to lift the finger off the reader.



7

Figure 7 - 28
Fingerprint Enrollment Tutorial

- Keep placing the finger flat on the reader, and lifting it off the reader as instructed, until the progress bar reaches **100%** to enroll that finger.

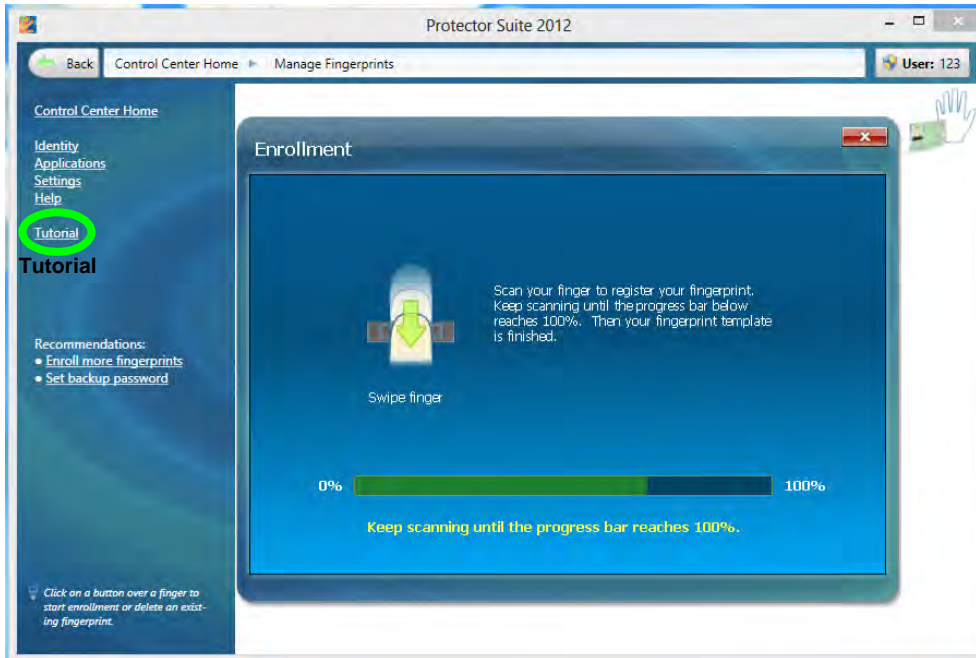

Figure 7 - 29
Fingerprint
Enrollment Process

- Repeat the process for all the fingers you wish to enroll (see sidebar).
- You can then click any of the sidebar menu headings to go to **Control Center Home, Identity, Applications, Settings** or **Help**.

11. It is recommended you set a strong backup password.
12. Click **Set backup password** and then enter a password of your choice and click **Apply**.

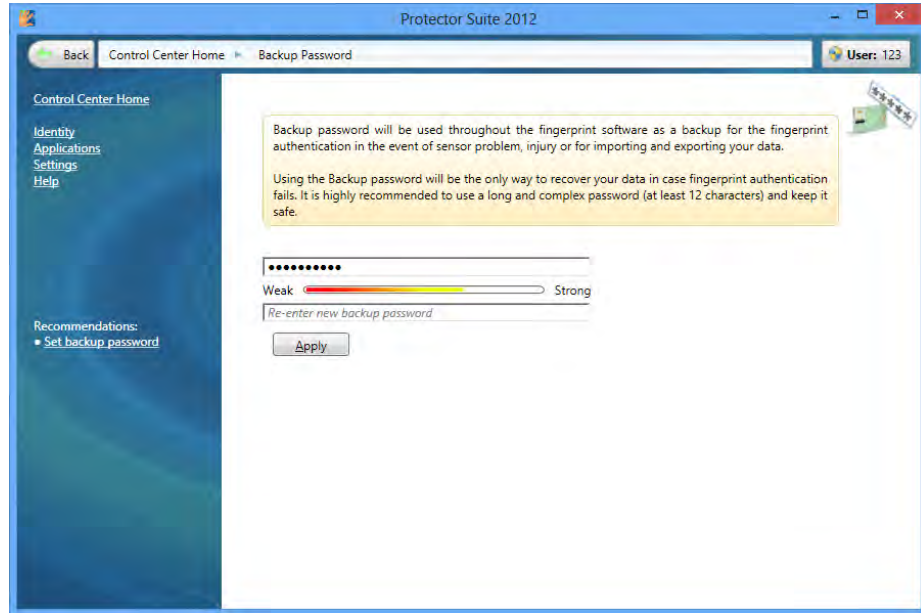



Figure 7 - 30
Set Backup Password

13. Right-click the taskbar icon  and select **Start Control Center** (and place a finger on the reader) to allow you to **Edit Fingerprints**, register **Applications**, edit **Settings** and access the **Help** menu etc. You can also run the **Control Center** etc. from the **Protector Suite** item in the **All Programs** menu.
14. Click **“Help”** in **Control Center Home** to get more information on any topic.
15. You can also run the **Tutorial**, or **Product Tour** video to get more information.

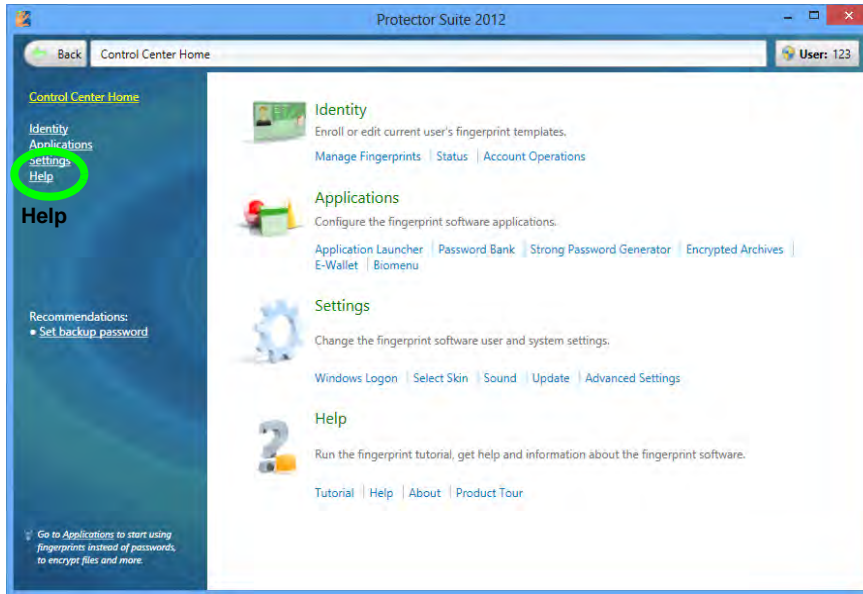

Figure 7 - 31
Control Center

16. See **“Help” on page 7 - 45** for further details.

Modules

17. If you place a finger on the reader at any time you can access the **Biomenu** to **lock the computer**, **register websites**, access the **Personal Safe or E-Wallet**, open the **Control Center** and access the **Help** menu etc.



7
Figure 7 - 32
Biomenu

Protector Suite - Fingerprint Control Center Features

Application Launcher

The **Application Launcher** allows you to register applications to be launched when assigned to a particular finger. Simply copy the application icon on to one of the registered fingers and then click OK to close the application window. Once registered the application will launch when you swipe the appropriate finger across the sensor.

E-Wallet

The **E-Wallet** can be used to store all your important information such as credit card details, account details etc. It can be used to help you complete complex online forms (e.g. when online shopping) as it stores frequently. You can create E-Wallet records and drag and drop them onto forms when required. See the Help file for more information.

Password Bank

The **Password Bank** stores registrations of user names, passwords and other settings for web sites etc.

Personal Safe

The **Personal Safe** is an encrypted area assigned on your hard drive that allows you to store files and folders to be protected by fingerprint protection.

Strong Password Generator

This is used to generate complex passwords, immune to dictionary attacks.



Help

For more information on these and other features simply access "**Help**" in the **Fingerprint Control Center** and select the item from the menu on the left.

BioExcess Application

The **BioExcess** application is used in conjunction with your fingerprint reader to enroll fingerprints and manage settings etc.

User Enrollment

1. Run the **BioExcess** application from the **Start** screen.
2. Identify your **fingerprint sensor** (11 Fingerprint Reader Module in *Figure 1 - 2 on page 1 - 6*).
3. Click **Next** when the **Initial Wizard** appears.
4. Swipe a finger to practice enrollment (click **Next** to skip this step).

7

Figure 7 - 33
Enrollment Tutorial

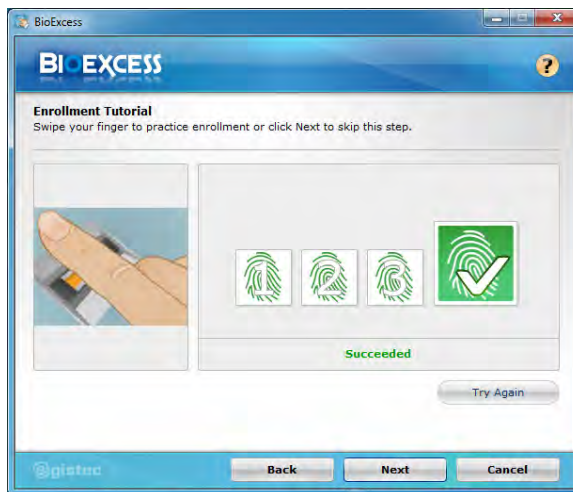

5. Enter your **Windows** log on **password**, and then click **Next**.
6. Click on the fingerprint diagram to select any finger to enroll.
7. Swipe the finger until the finger is enrolled and then repeat for other fingers.
8. Click **Next** to continue once you have enrolled a number of fingerprints.



9. Click **Finish** when the **Initialization Successful** message appears (if you have selected **Launch Control Center** then it will be run on exiting the wizard).



Fingerprint Enrollment

Note that it is strongly recommended that you enroll more than one finger in case of injury etc. See page 8 - 11 for further information on scanning fingers

Figure 7 - 34
Fingerprint Enrollment

BioExcess Control Center

Run **BioExcess** application and swipe a registered finger to run the **Control Center** (or swipe a finger across the fingerprint sensor and select Control Center from the **BioExcess Menu**).

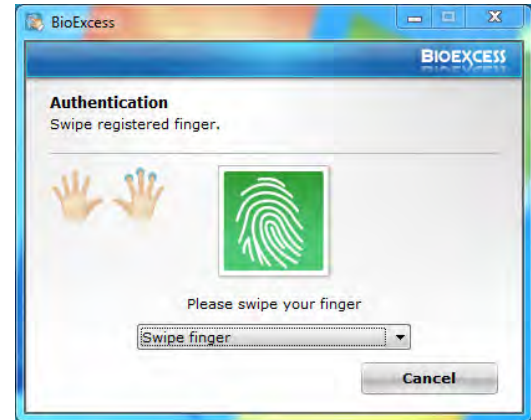

Figure 7 - 35
BioExcess Menu & Authentication

Use the **Control Center** to adjust all the BioExcess application settings. Click on any of the menu headings to access the sub-menu to adjust functions or settings including **Fingerprint Management**, **Data Protection**, **Online Accounts Management**, **General settings** and **Information**.



Help

Click the **Help**  icon and select a help topic from the drop-down menu. Select a topic from the **Contents** menu or **Search** for help on a specific area.

Figure 7 - 36
Control Center

Fingerprint Management

Fingerprint Enrollment: You can add or delete enrolled fingers by clicking in the box above any of the fingers.

Application Launcher: Use any of your fingers to launch any chosen **application, website, online account** or use **Launch Express** to launch functions such as Shut Down, Windows Lock etc. Click **OK** to save any changes made to these settings.

- Click on any of the boxes above an enrolled finger and select the item from the drop-down menu.



Figure 7 - 37
Application
Launcher

- Simply drag and drop an **executable file** onto any enrolled fingers to launch an application, or click and select **Launch Application** and then browse to the executable file.
- Select **Launch Web Site** and then input the URL to use a finger to go to any website.
- **Auto Login** will prompt you to choose an account to select to login to when a finger is swiped.
- **Launch Express** will allow you select one of a number of functions (e.g. shutting down the computer) when the appropriate finger is swiped.



Figure 7 - 38
Launch Express

Data Protection

File Encryption/Decryption: Click **Add** or drag and drop any file for encryption/decryption. Click **Encrypt** and you will be asked for a backup password for the file. You can right-click any file and select **Decrypt/Encrypt File** from the BioExcess item in the menu. See the **Help**  file for further information.

Secure Drive Access: You can access your secure drive here. The secure drive is a personal virtual drive that may only be open and closed by means of the authenticated fingerprint or password. Use the **BioExcess Menu** (swipe a finger across the sensor) or the click the icon in the notification area of the taskbar to open and close (make sure you have saved any file data before closing) the secure drive. See page [7 - 54](#) for information on how to set the drive's **location** and **capacity**.

Figure 7 - 39
Taskbar Notification Area Menu (Open/Close Secure Drive)

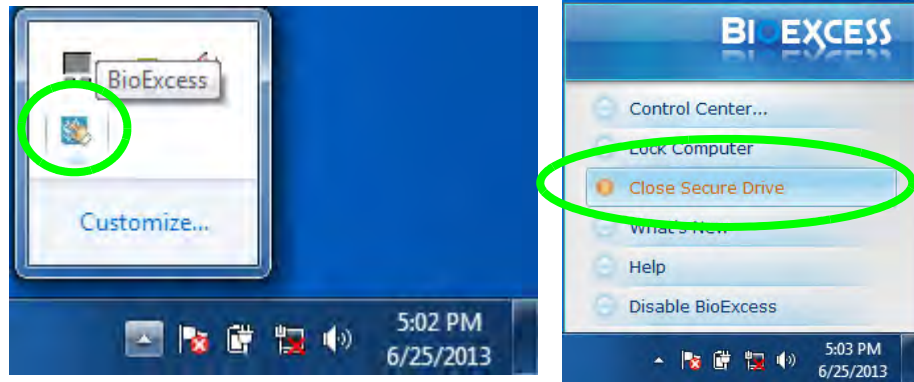

Online Accounts Management

You can store user IDs and passwords for websites and/or applications and the software will then automatically fill in your log on and password information for you when you swipe your finger. When you visit a registered website or program you will see a BioExcess icon in the top left of the screen prompting you to swipe a finger to log on. See **Help**  for more information on registering and managing online accounts.

Security Check will assess the password strength for any of your online accounts by indicating if it is weak, medium or strong. If your password is assessed as weak then it is suggested you change it.

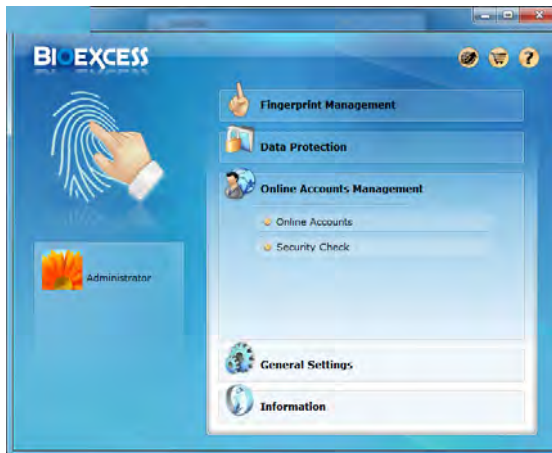

Figure 7 - 40
**Control Center
Online Accounts
Management**

General Settings

User Settings: Fast User Switch enables multiple users to switch to their own *Windows* environment with the swipe of a finger. Use **Pre-Boot Authentication** to prevent the *Windows* OS from loading until the password has been confirmed.

Password Settings: You can change your backup password and *Windows* password settings from this menu.

Secure Drive Settings: You can **open/close**, **change drive location** and **change the capacity** of the secure drive from this menu.

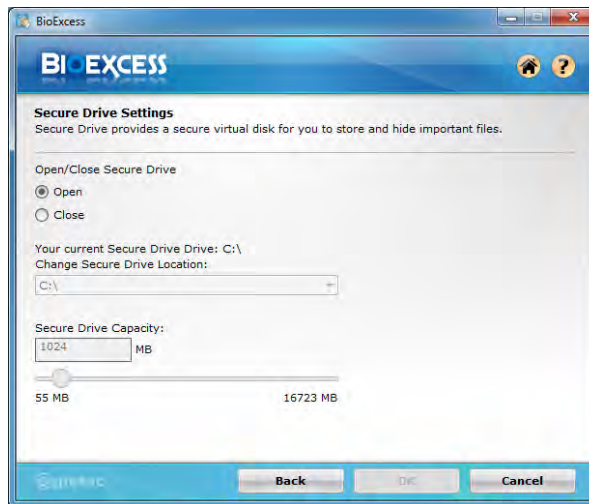

7
Figure 7 - 41
Control Center
Secure Drive
Settings

Data Backup Settings: Use this menu to set the **location** of the back up data (click **Browse** and set location), manage the backup password and to select which items are backed up (enrolled fingerprints and online accounts data).

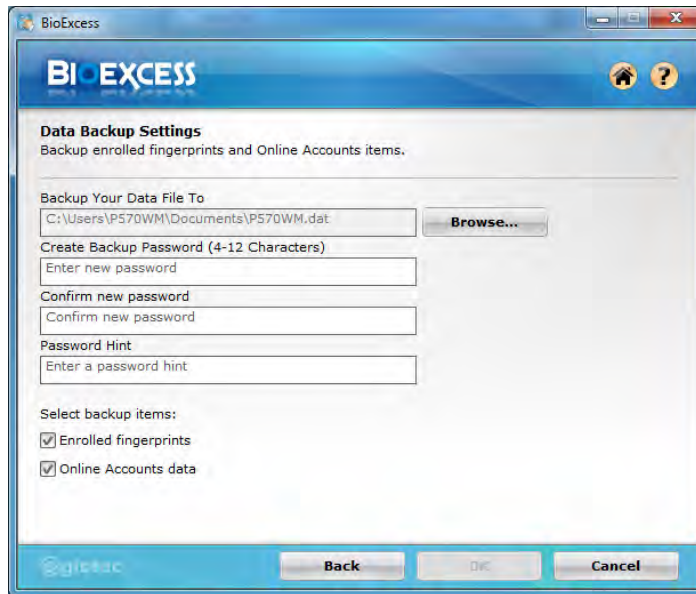

Figure 7 - 42
Control Center
Data Backup
Settings

Data Restore Settings: If you need to restore previously backed up data then do so from this menu. Click **Browse** and go the location of the original backup, and input the password.

Information

These menu items provide online information on your software version, support and any new features. You can also access the animated **Tutorial** on **Online Accounts**, **Swipe One** and **Secure Drive**.

Figure 7 - 43
Control Center
Information



Bluetooth & WLAN Combo Module

If your purchase option includes the **Combination Wireless LAN & Bluetooth module** (either **Intel®** or **3rd Party**) then install the driver as instructed overleaf.

Make sure that the module is on (i.e. the system is not in **Airplane Mode**) before installing the driver.



Bluetooth Data Transfer

Note that the transfer of data between the computer and a Bluetooth enabled device is supported in one direction only (simultaneous data transfer is not supported). Therefore if you are copying a file from your computer to a Bluetooth enabled device, you will not be able to copy a file from the Bluetooth enabled device to your computer until the file transfer process from the computer has been completed.

Note that you need to install both the WLAN & Bluetooth drivers for the WLAN & Bluetooth Combo modules, however the Qualcomm Atheros WLAN (Combo) module only requires the WLAN driver installation.



Wireless Device Operation Aboard Aircraft

The use of any portable electronic transmission devices aboard aircraft is usually prohibited. Make sure the **WLAN & Bluetooth module(s)** are **OFF** if you are using the computer aboard aircraft by putting the system in to **Airplane Mode** (see [Table 1 - 6, on page 1 - 19](#)).



High Speed Bluetooth Data Transfer

The **Combination Wireless LAN & Bluetooth module** supports high speed data transfer. However to achieve such transfer speeds, **both devices must support high speed data transfer.**

To obtain high speed data transfer make sure that both the **WLAN and Bluetooth modules are powered on.**

Check your Bluetooth compatible device's documentation to confirm it supports high speed data transfer.

3rd Party Bluetooth (V4.0) Combo Driver Installation

1. **Make sure the system is not in Airplane Mode**, and then insert the *Device Drivers & Utilities + User's Manual* disc into the DVD drive.
2. Click **Option Drivers** (button).
3. Click **3.Install Combo BT Driver > Yes.**
4. Click **Next.**
5. Click **Finish** to restart the computer.
6. See "[Bluetooth Configuration in Windows 8](#)" on page 7 - 59 for configuration instructions.



Intel Bluetooth Combo Driver Installation

1. **Make sure the system is not in Airplane Mode**, and then insert the *Device Drivers & Utilities + User's Manual* disc into the DVD drive.
2. Click **Option Drivers** (button).
3. Click **3.Install Combo BT Driver > Yes.**
4. Click **Next > Next.**
5. Click in the tickbox to accept the license and click **Next.**
6. Click **Next > Finish.**
7. See "[Bluetooth Configuration in Windows 8](#)" on page 7 - 59 for configuration instructions.

Bluetooth Configuration in Windows 8

You can configure a Bluetooth connection as below, however make sure the Bluetooth module is on (i.e. not in Airplane Mode) before configuration begins.

Desktop Mode

1. Switch to the Windows Desktop (click the App or use the Windows logo key  + **D** key combination).
 2. Click the notification area of the taskbar and double-click the Bluetooth icon  (or click and select **Show Bluetooth Devices**).
 3. The **Devices** item in **PC Settings** will appear.
- OR

Charms Bar

1. Go to the **Charms Bar**.
2. Select **Settings** and then click **Change PC Settings**.
3. The **Devices** item in **PC Settings** will appear.

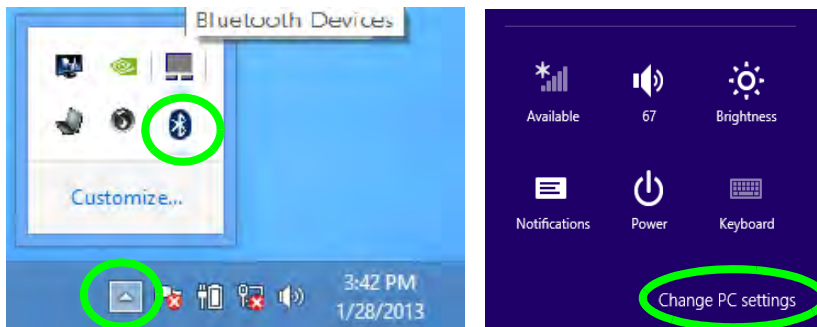
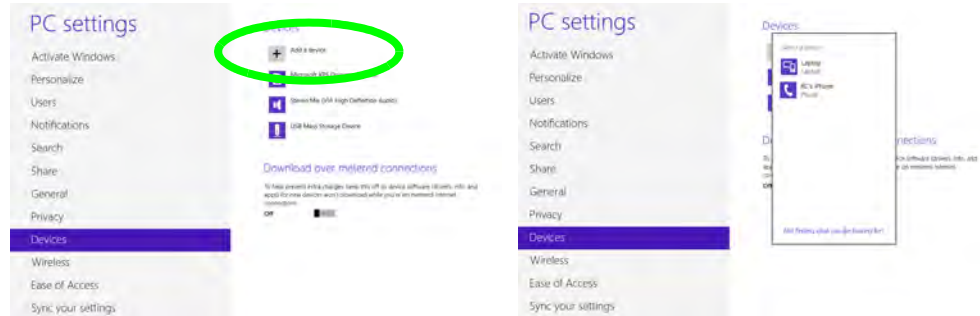

Figure 7 - 44
Bluetooth Taskbar
Icon & Change PC
Settings (Charms
Bar -Settings)

4. Click **Add a Device**.
5. Double-click the device you want to pair with the computer.

Figure 7 - 45
PC Settings
(Devices)
Add A Device



6. On first connection the computer will provide you with a pairing code to be entered onto the device.

Figure 7 - 46
Enter the Passcode

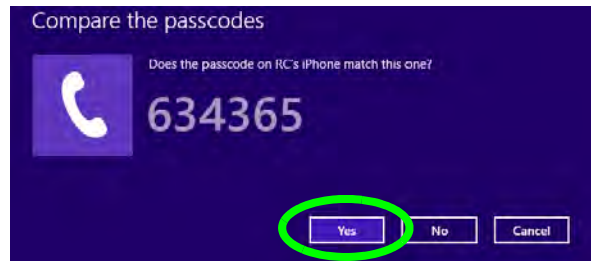

7. Enter the code into your Bluetooth enabled device and click **Yes** on the computer to complete the pairing.

8. You need to either use **Airplane Mode**, or to **turn the Bluetooth module off** aboard aircraft.

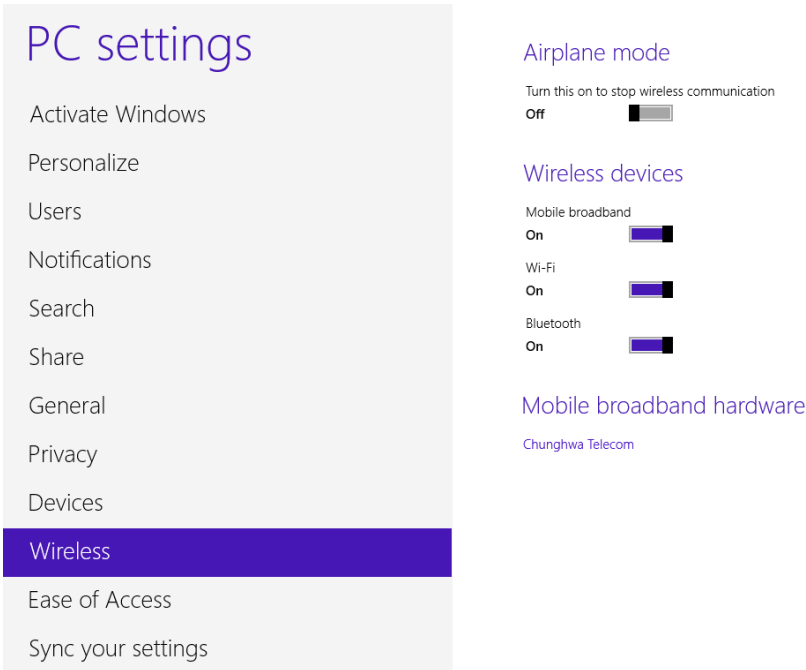

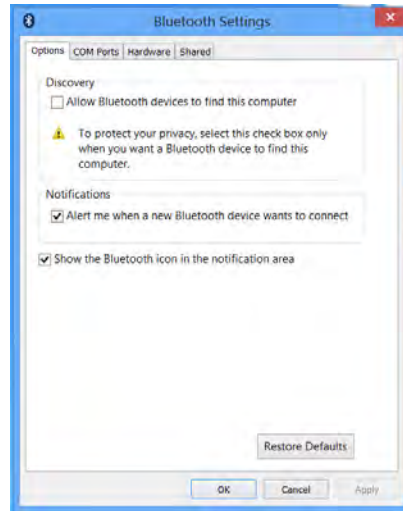

Figure 7 - 47
PC Settings (Wireless)

To Make your Computer Discoverable to Bluetooth Devices

1. Switch to the Windows Desktop (click the app or use the Windows logo key  + **D** key combination).
2. Click the notification area of the taskbar, click the Bluetooth icon  and click **Open Settings**.
3. Click **Options**, and make sure that **Allow Bluetooth devices to find this computer** check box (**Discovery**) has a tick inside it.
4. Make sure that the **Alert me when a new Bluetooth device wants to connect** check box (**Connections**) has a tick inside it, if you want to be notified when a Bluetooth device wants to connect.



7
Figure 7 - 48
Bluetooth Settings

Trusted Platform Module

The **TPM security chip** allows you to create and manage digital certificates for user and platform authentication. This type of security is usually administered within large enterprises and organizations, and therefore requires implementation by a system administrator before users can access security features.

Individual users can use the TPM as an authentication with the fingerprint reader.

Make sure you have administrator's rights to your computer, and have a *Windows* password enabled for full security protection. In addition **Make sure you prepare a removable media (e.g. a USB flash drive) to store passwords etc. before beginning the TPM initialization process.**

Before setting up the TPM functions you must initialize the security platform.

Enabling & Activating TPM

1. Restart the computer.
2. Enter the **Aptio Setup Utility** pressing **F2** during the POST/startup.
3. Use the arrow keys to select the **Security** menu.
4. Select **TPM Configuration** and press Enter to access the sub-menu.
5. Press Enter to access the **Security Device Support** menu and select **Enable** to display the full **TPM configuration** menu.
6. Select **TPM State**, press Enter and select **Enable** to change the TPM state to enabled. You will then need to press **F4** to save the changes and restart the computer.

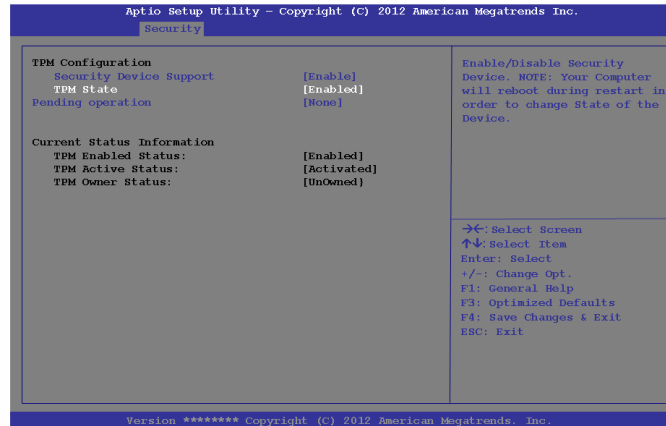

Figure 7 - 49
TPM State
(Enabled)

7. As the computer restarts press **F2** to enter the BIOS again and go to the **TPM Configuration** menu.

8. Select **Pending operation**, press Enter and select the option you require (if you are initializing TPM you should select **Enable Take Ownership**). You will then need to press **F4** to save the changes and restart the computer.

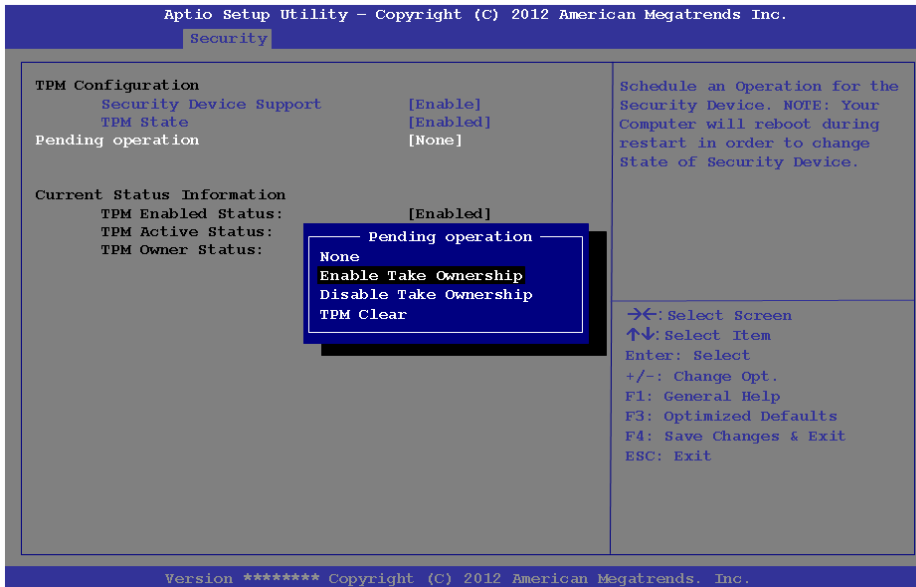

Figure 7 - 50
Pending TPM
operation
(Enable Take
Ownership)

9. You can now **install the TPM driver** (see ***“Trusted Platform Module (TPM) Driver Installation” on page 7 - 66***) and then initialize the TPM.

Trusted Platform Module (TPM) Driver Installation

1. Make sure you have enabled and activated the TPM in the BIOS before installing the driver.
2. Insert the *Device Drivers & Utilities + User's Manual* disc into the DVD drive.
3. Click **Option Drivers** (button).
4. Click **4.Install TPM Driver > Yes**.
5. Click **Next**.
6. Click the button to accept the license and click **Next**.
7. Click **Next > Next > Install**.
8. Click **Finish > Yes** to restart the computer.

Initializing TPM



1. Switch to the Desktop app and click the TPM icon right-click the icon  in the notification area of the taskbar, and select **Security Platform Initialization** (or click the **Security Platform State** taskbar bubble).
2. Click **User Settings** (tab) and click **Yes**, or right-click the icon  in the notification area of the taskbar, and select **Security Platform Initialization** (or click the **Security Platform State** taskbar bubble).
3. The **Quick Initialization** method will automatically be selected for you (if you need to use advanced settings provided by your network administrator then select **Advanced Initialization**).
4. You will need to use a removable media (e.g. a USB Flash Drive) to store passwords and data (keep the media in a safe place until required).
5. Select the drive you want to use from the drop-down menu and click **Next**.



Figure 7 - 51
**Security Platform
 Quick Initialization
 Wizard**

Modules



Help

Right-click the icon  in the notification area of the taskbar to bring up the menu to select **Help** or **How to use the Security Platform Features**.

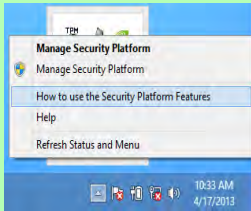



You can also click the **Help** button in any of the Infineon Security Platform Settings Tool tabs to bring up specific help topics on each tab.

Figure 7 - 52
Settings

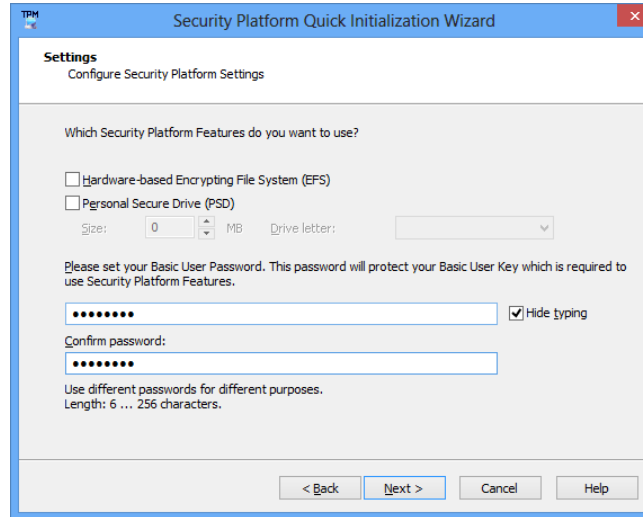
6. Choose the **Security Platform Features** you want to use by clicking the appropriate tickbox.
7. Enter a **Basic User Password** (and re-type to confirm it) and click **Next**.



8. Click **Next** to confirm the settings.
9. The computer will then initialize the settings.
10. Click **Finish**.
11. Click the tabs and control panels to adjust the settings.
12. Double-click the icon  in the taskbar notification area to access the **Infineon Security Platform Settings Tool**, or right-click the icon  and select a menu item.

Infineon Security Platform Settings Tool

The Infineon Security Platform Settings Tool allows you to manage and check the TPM state, manage your password information, and to backup and restore the TPM data. As TPM is usually administered within large enterprises and organizations, your system administrator will need to assist you in managing the information here.



Menus

Note that not all the menus pictured here will be available for access. The menu items that appear will be dependent on your configuration settings etc. (see the **Help** file for full details).

Figure 7 - 53
Infineon Security Platform Settings Tool

User Settings

This page allows the settings to be configured for the currently logged in Infineon Security Platform user including the ability to change the password, configure secure e-mail, file and folder encryption and Enhanced Authentication. You can also import or delete certificates protected by the security platform.

Figure 7 - 54
**Infineon Security
Platform Settings
Tool (User Settings)**

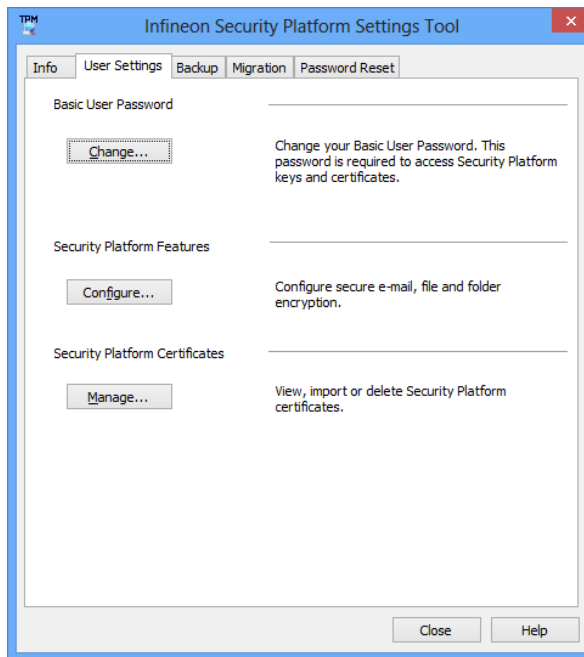

Backup

Here you can configure backup and restore operations. Backup files contain the computer identification and user identification information which is used to match the machine name and user name with the current machine and user during restoration.

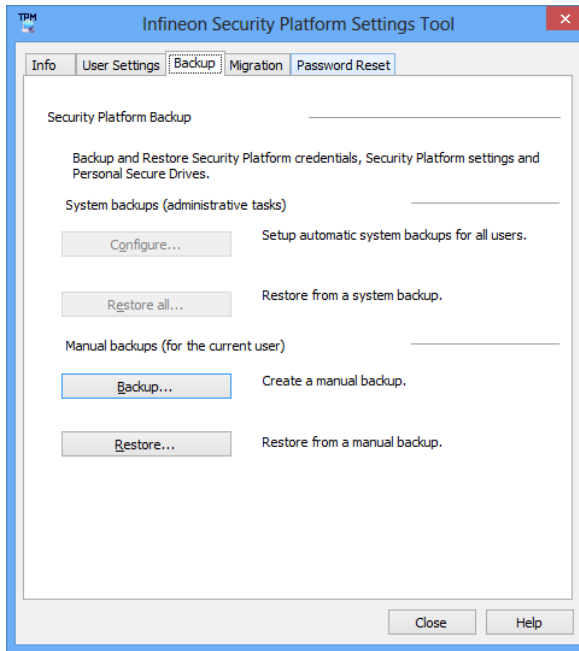
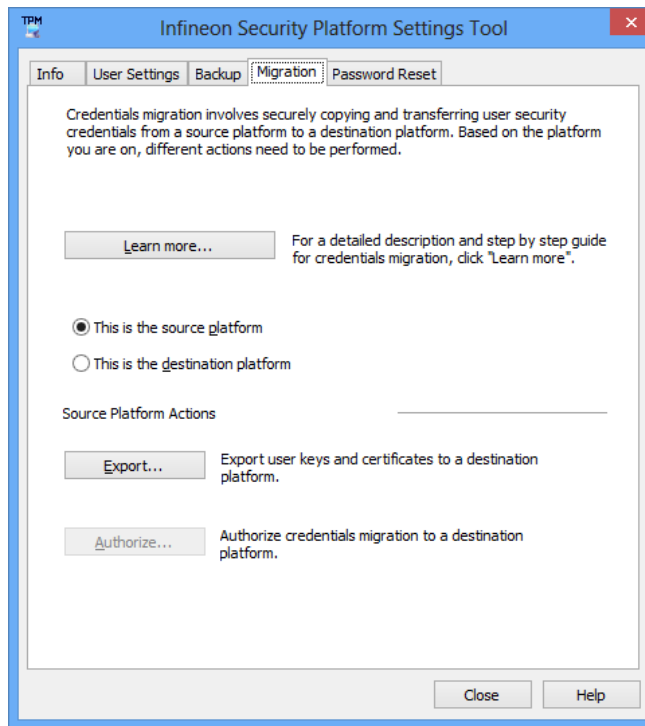

Figure 7 - 55
Infineon Security Platform Settings Tool (Backup)

Migration

The Migration tab is used to help securely transfer keys and certificates from one platform to another.

Figure 7 - 56
Infineon Security Platform Settings Tool (Migration)



Password Reset

Use Password Reset to reset basic user passwords when required.

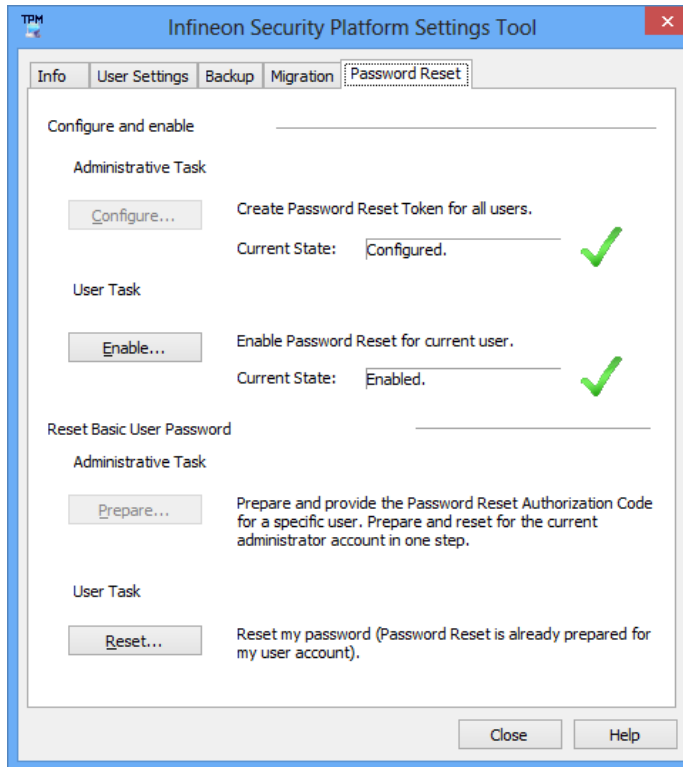
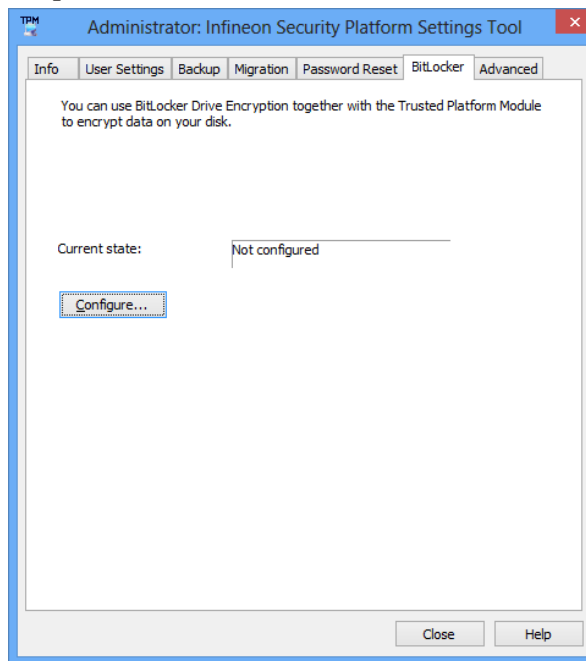

Figure 7 - 57
Infineon Security Platform Settings Tool (Password Reset)

BitLocker

BitLocker Drive Encryption can be used in conjunction with the TPM to encrypt data on the disk and is done via the **Microsoft BitLocker Control Panel Applet**. Click **Configure** and select a drive to be encrypted and then follow the Wizard to begin the encryption process.

Figure 7 - 58
**Infineon Security
Platform Settings
Tool
(BitLocker)**



Access the Microsoft **BitLocker Drive Encryption** control panel applet from the *Windows* control panel (**System and Security**).

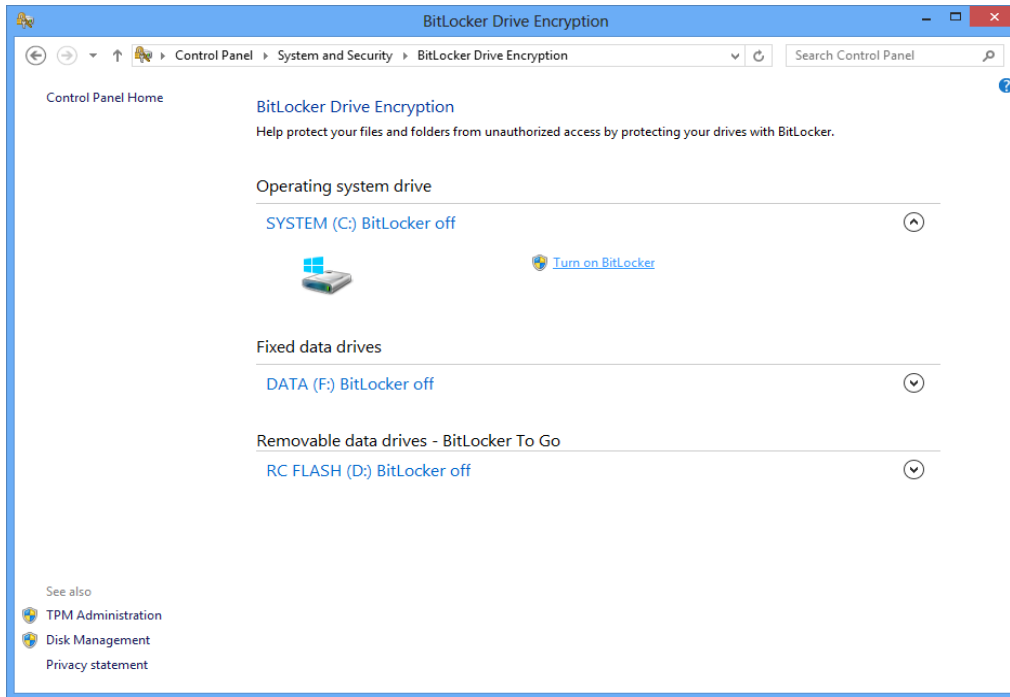
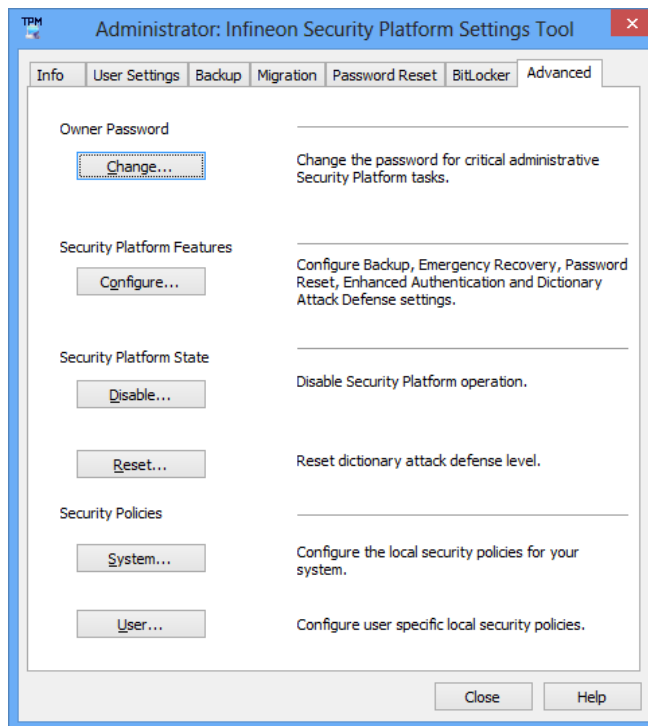

Figure 7 - 59
BitLocker Drive Encryption

Advanced

Configure all the Security Platform owner and policy settings from the Advanced tab. The settings that can be changed are for the local computer only.

Figure 7 - 60
**Infineon Security
Platform Settings
Tool
(Advanced)**



Sound Blaster Audio

Install the **Sound Blaster AP** to allow you to configure the audio settings to your requirements for the best performance in games, music and movies.

Sound Blaster X-Fi MB-3 Audio AP Installation

1. Insert the *Device Drivers & Utilities + User's Manual* disc into the DVD drive.
2. Click **Option Drivers** (button).
3. Click **5.Install SBX-Fi MB 3 AP > Yes**.
4. Click **Yes** to accept the license.
5. Click **Next > Full Installation** (button).
6. Click **Next > Finish** to restart the computer.

Run the **Sound Blaster X-Fi 3** control panel from the notification area of the taskbar (or from the item in the Start screen). Click on the tabs to access the any of the control panel menus.

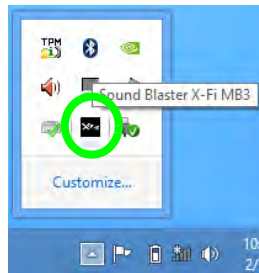
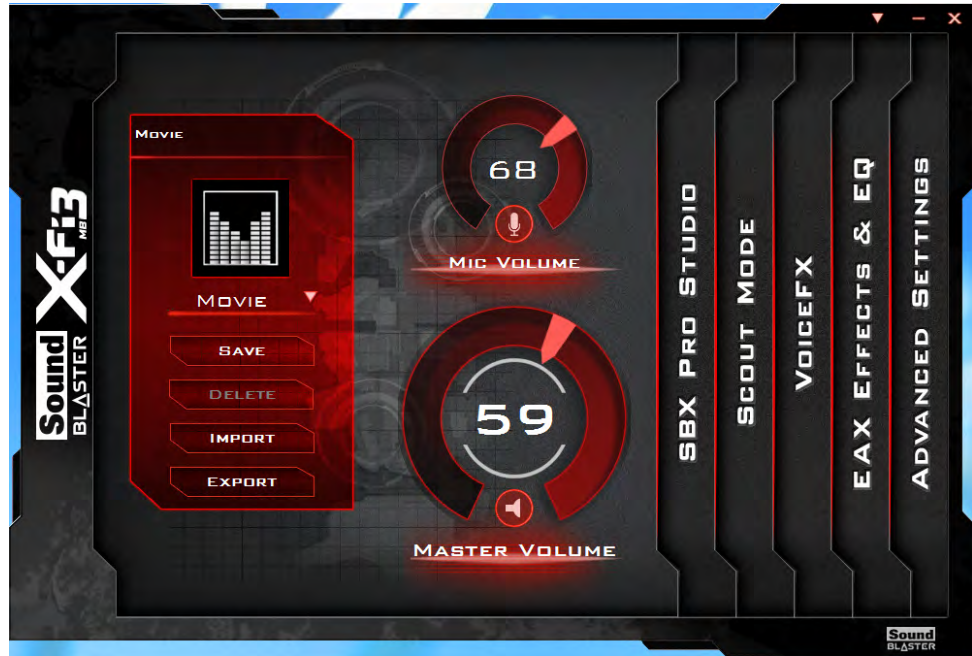

Figure 7 - 61
**Sound Blaster X-Fi
MB 3
(Taskbar
Notification Area
Icon)**

Volume Controls

You can click on the volume dials to adjust the level for either the microphone or master volume. You can choose to save the settings for **Music**, **Movie** or **Game**, and these settings can be exported or imported as required.

Figure 7 - 62
Sound Blaster X-Fi 3
Volume Controls



SBX Pro Studio

Click the tickbox to enable/disable the control, and use the slider to adjust the levels. Press the play  button to test settings.

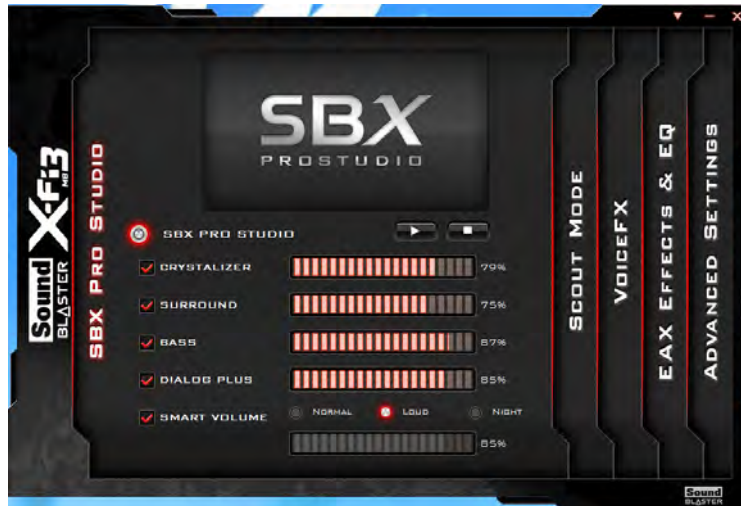

- **Crystalizer:** Enhances audio to make it sound livelier.
- **Surround:** Provides virtual sound channels to control the level of immersion.
- **Bass:** Enhances the bass level of the sound system.
- **Dialog Plus:** Enhances dialogue levels for movies etc.
- **Smart Volume:** Minimizes sudden volume changes to avoid the need for constant adjustment. It is recommended that this is set to **Loud** (see sidebar).



Smart Volume Setting

The default setting for **Smart Volume** in **SBX Pro Studio** is set to **Normal**.

To get the full effect of this setting it is recommended that you set it to **Loud**.

Figure 7 - 63
Sound Blaster X-Fi 3
SBX Pro Studio

Scout Mode

Click in the box to enable **Scout Mode** to enhance your ability to hear enemies in games from a further distance away than would normally be possible.

Figure 7 - 64
Sound Blaster X-Fi 3
Scout Mode



Voice FX

Click in the box to enable **Voice FX** and click on the sliders to adjust the settings. Select the mode required from the dropdown, and click on **Test** to hear the playback of the effect.

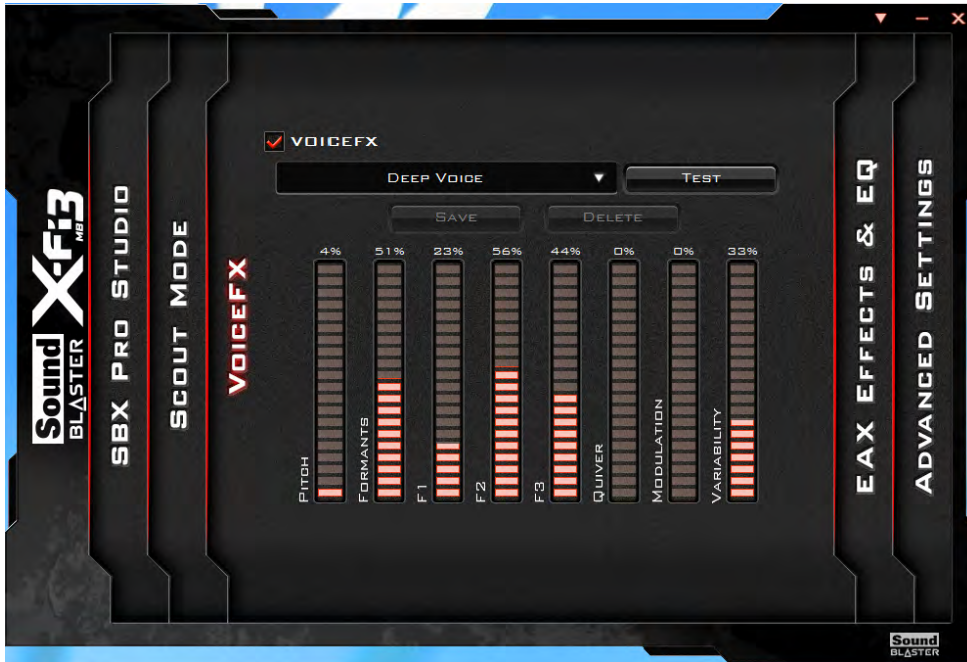
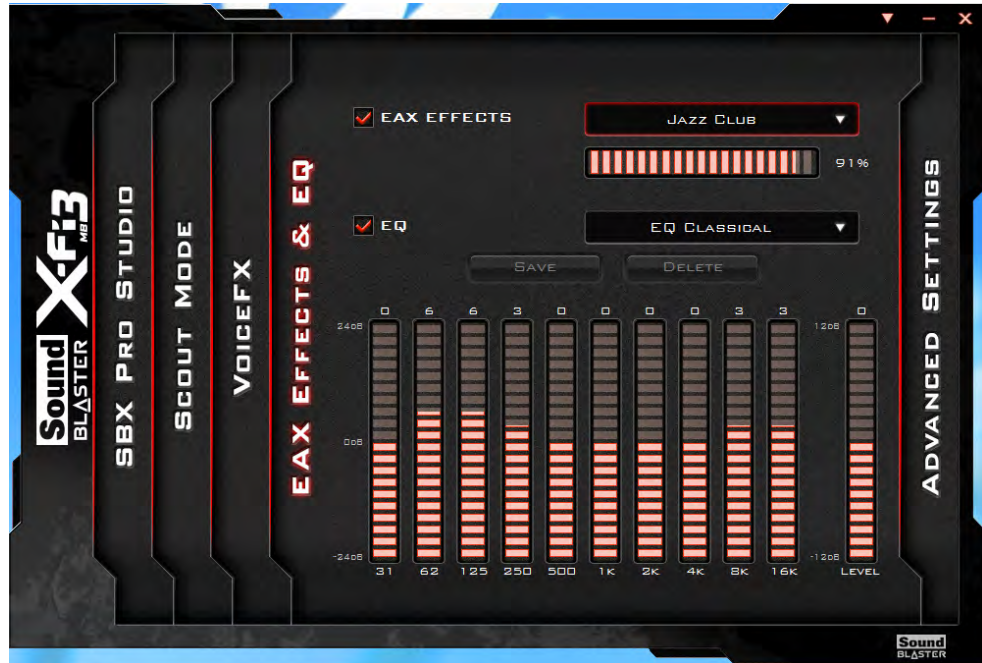

Figure 7 - 65
Sound Blaster X-Fi 3
Voice FX

EAX Effects & EQ

Click to select either/or **EAX Effects** or **EQ**, select the mode required from the drop-box and click on the sliders to adjust the settings. Click on **Save** to save any custom changes to the set levels and effects.

Figure 7 - 66
Sound Blaster X-Fi 3
EAX Effects & EQ



Advanced Settings

Select the speaker/headphone configuration from the dropdown, and click on **Test** to hear the effect. You can also adjust the **Bass Management** by clicking the **Bass Redirection** and **Subwoofer Gain**, and click on the slider to adjust the **Crossover Frequency**.

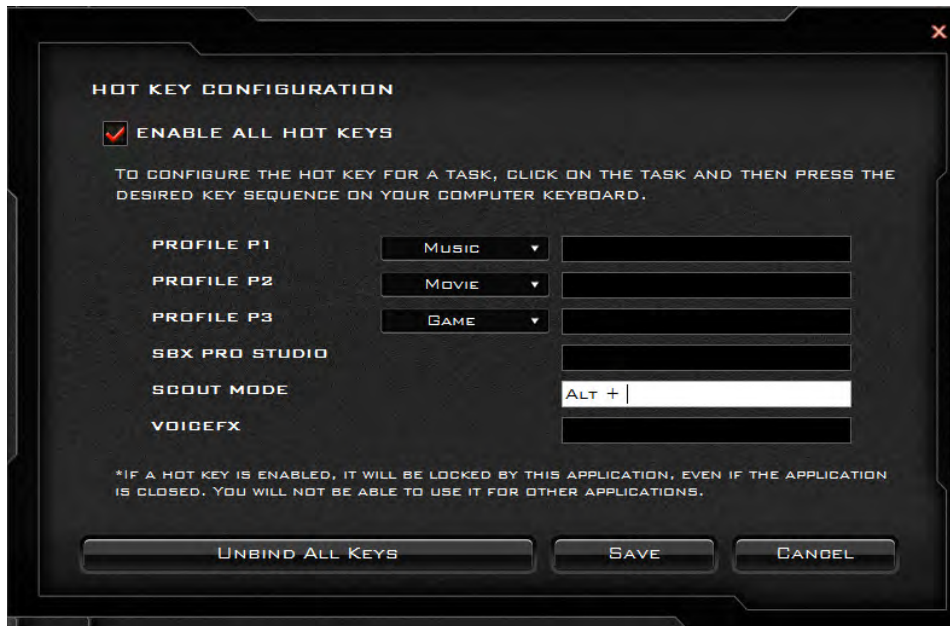

Figure 7 - 67
Sound Blaster X-Fi 3
Advanced Settings

Hot Key Configuration

Click **Configure Hot Keys** in **Scout Mode** or **Advanced Settings** menus to access the **Hot Key Configuration** menu. Click **Enable All Hot Keys**, and then click on the task and press the key sequence required. Any hotkeys chosen will be locked by the application, and therefore will not be able to be used in other applications.

Figure 7 - 68
Sound Blaster X-Fi 3
Hot Key
Configuration



Creative ALchemy

The Creative ALchemy application can be run from the shortcut in the **Start** menu. Use the left menu to select any installed games and click the button to move them to the right column to enable ALchemy support for the game. Creative ALchemy restores hardware accelerated audio to enable EAX effects and 3D Audio when playing Direct Sound3D games.

Creative Software AutoUpdate

Run the application from the shortcut in the **Start** menu and make sure you are connected to the internet, then click **Next** and follow the on screen instructions to update the software.

Sound Blaster Audio & HDMI

1. When you connect an HDMI display to the HDMI-Out port, the Sound Blaster controls will be disabled.
2. A warning box will pop-up and will prompt “...***Do you want to select another audio device now?***”.
3. Click **No** to continue using the HDMI audio output from your external display (do not attempt to select another audio device when connected to the external HDMI display).



Intel® Control Center

The **Intel® Control Center** provides a central starting point to make it easier to find any Intel® programs you need to use.

Intel® Smart Response Technology

If you have a Solid State Drive (SSD) installed you may configure **Intel® Smart Response Technology** for your system (see page [7 - 92](#)).

Intel® Rapid Storage Technology

The **Intel Rapid Storage Technology application** provides high-performance SATA and SATA RAID capabilities. Install the **Intel Rapid Storage Technology application** (after installing all necessary drivers in the correct order) to support your **RAID** system or SATA drive if set up in **AHCI mode** in the BIOS (see [“SATA Mode \(Advanced Menu\)” on page 5 - 10](#)).

IRST Driver Installation

1. Insert the *Device Drivers & Utilities + User's Manual* disc into the DVD drive.
2. Click **Option Drivers** (button).
3. Click **6.Install IRST Driver > Yes**.
4. Click **Next > Next**.
5. Click the tickbox to accept the license and click **Next**.
6. Click **Next > Next > Next**.
7. Click **Finish** to restart the computer.

See the following pages for more information if you have set your hard disks up in a RAID configuration.

Intel® Rapid Storage Technology for RAID Systems

Intel® Rapid Storage Technology application displays status information on your RAID configuration. Run the **Intel® Rapid Storage Technology** application from the item in the **Start** screen.

When the **Intel® Rapid Storage Technology** application is launched the system will open the **Status** window. Here you can view the general health of the storage system. Various volume creation and management options are available depending on the system's status.

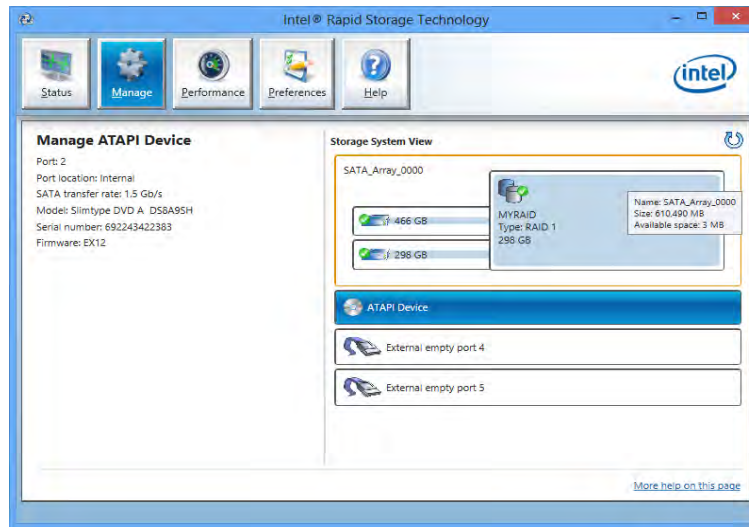

Figure 7 - 69
**Intel® Rapid
Storage Technology
Status**



Help

Click the **Help** (or press **F1**) menu button at the top of the **Intel® Rapid Storage Technology** application.

Click **Contents** to view the general list of subjects covered, click **Index** or **Search** for a more specific help topics on a particular item.

Click **More help on this page** at the bottom of any page for page specific help.

Figure 7 - 70
Intel® Rapid Storage Technology Help

Intel® Rapid Storage Technology Help

If a hard drive member of a RAID volume is reported as **“Degraded”** or **“Failed”** it may be possible to recover the volume. If the volume cannot be restored then you will need to recreate the RAID volume and restore the data from a back up. Click the **Help** menu (or press **F1**) for instructions on how to recover or recreate RAID Volumes.

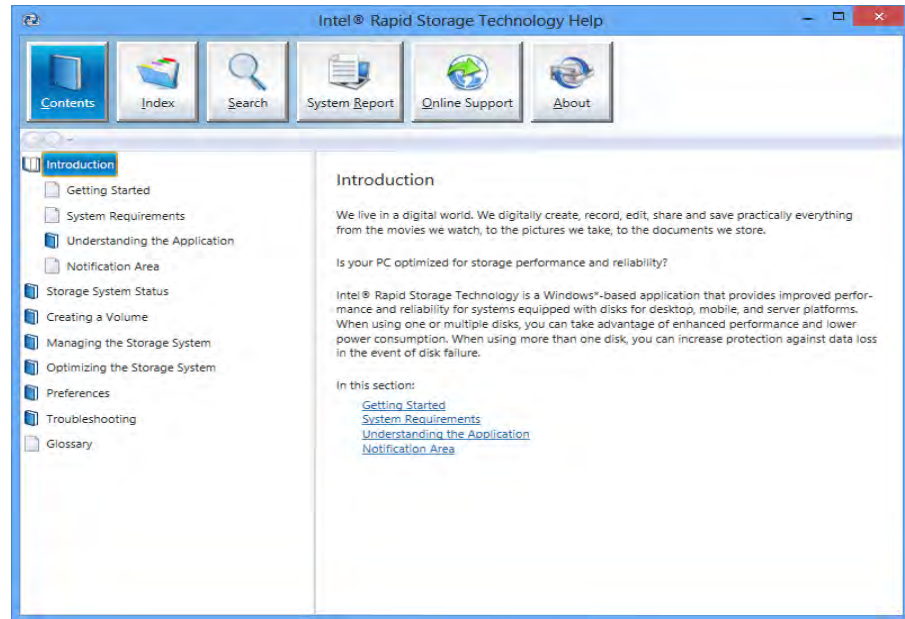

RAID Volume Data Verification and Repair

The RAID volume data verification process identifies any inconsistencies or bad data on a RAID 0 or RAID 1 volume. The table outlines what occurs for each RAID level:

| RAID Level | Verify | Verify & Repair |
|------------|---|---|
| RAID 0 | Bad blocks are identified. | N/A |
| RAID 1 | Bad blocks are identified. Data on the mirrored drive is compared to data on the source drive. | Bad blocks are reassigned. If the data on the mirrored drive does not match the data on the source drive, the data on the mirrored drive is overwritten by the data on the source. |

Table 7 - 2
**RAID Level
Verification &
Repair Status**

Replacing and Reverting Recovery and Master Volumes

If a master or recovery drive fails you will need to add a new identical drive and rebuild the recovery volume to the drive. You can also revert the master drive to the state of the previous volume update. For details on how to do this see the help file *“Intel® Rapid Storage Technology Help” on page 7 - 88.*

See over for details on how to verify and repair RAID volume data. Verification will identify and repair data inconsistencies on the volume.

Verifying and Repairing RAID Volume Data

1. Before verifying the volume data you will need to initialize the volume.
2. Run the **Intel® Rapid Storage Technology** application.
3. Click to **select the RAID** in the pane on the right side of the window.
4. Click **Manage** and click **Advanced**.
5. Click **Initialize** and click **Yes** (button) to begin the process.
6. The completion percentage will be listed under **Status**.

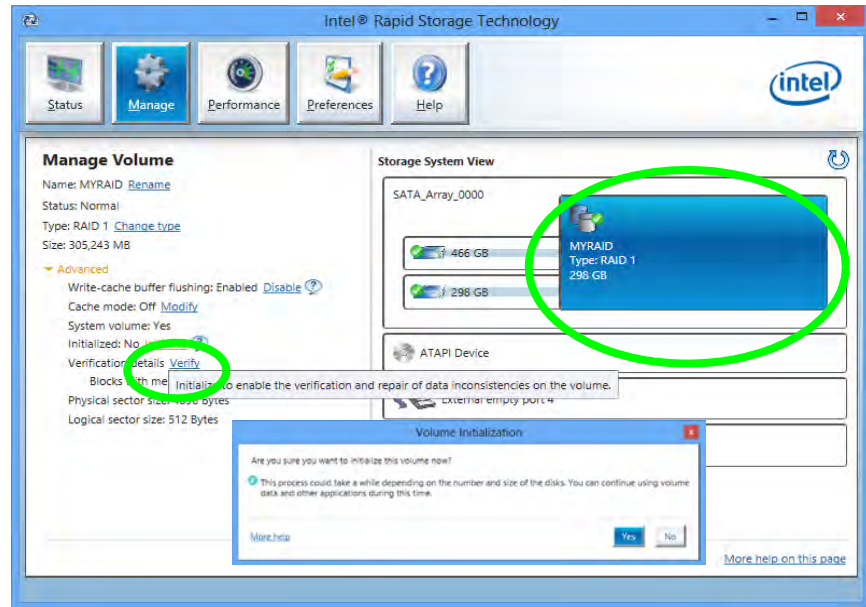

7
Figure 7 - 71
Intel® Rapid Storage Technology Initialize

7. Click **Advanced** and click **Verify**, then click **Verify** (button) to begin the process.
8. The completion percentage will be listed under **Status** (verifying and repairing).

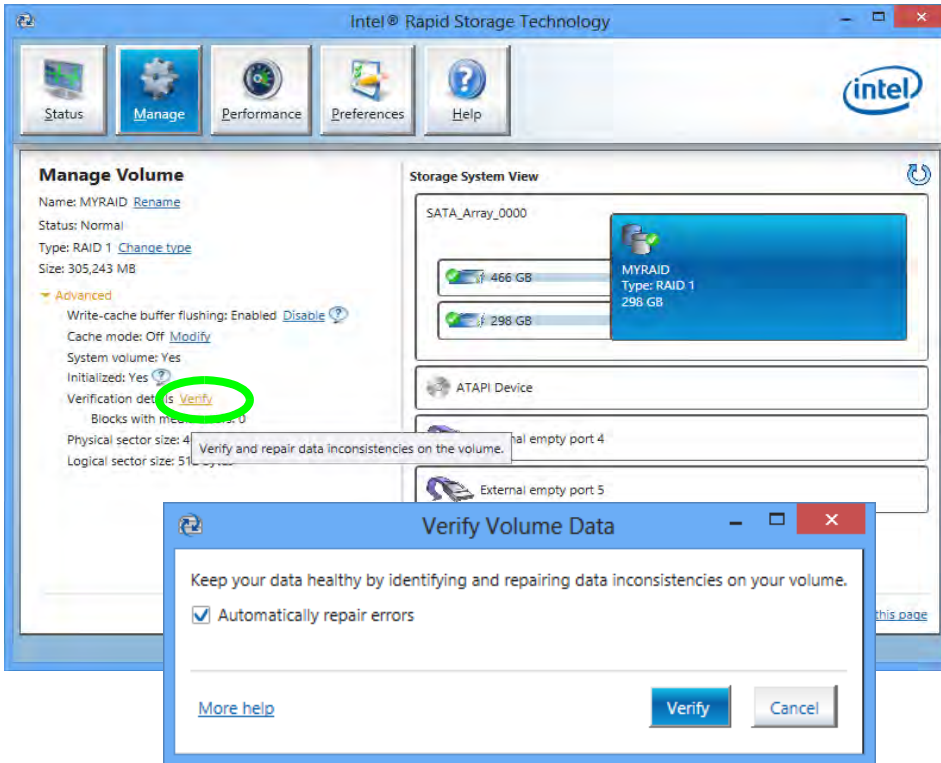

Figure 7 - 72
Intel® Rapid
Storage
Technology
Verify

Intel® Smart Response Technology

Intel® Smart Response Technology is an Intel® Rapid Storage Technology (RST) caching feature that accelerates computer system performance by using the SSD as cache memory between the hard disk drive and system memory.

System Requirements to support Intel® Smart Response Technology:

- System BIOS with SATA mode set to RAID (see *““SATA Mode (Advanced Menu)” on page 5 - 10*).
- Intel Rapid Storage Technology software installed.
- A Solid State Drive (SSD) with a minimum capacity of 18.6GB (or with a partition on the drive formatted to more than 18.6GB e.g a 20GB partition set on the SSD). Note that the SSD requires at least 5MB of free unpartitioned and unallocated space (if you have used all the disk space for the partition you will need to shrink some of space for the cache memory’s use).

Figure 7 - 73
Computer Management - Disk Management - Unallocated SSD Space

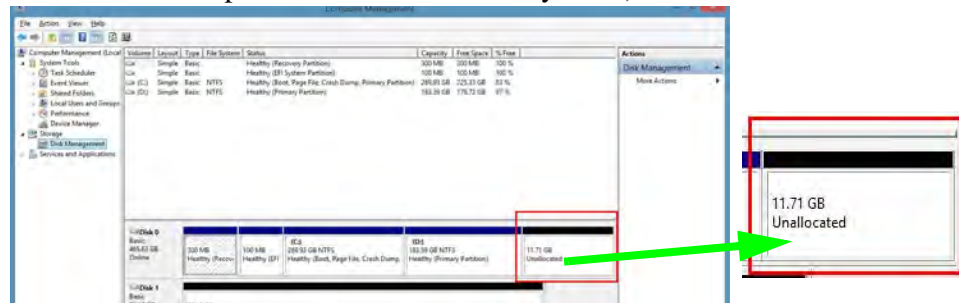

See overleaf for instructions on enabling Intel® Smart Response Technology.

Enabling Intel Smart Response Technology

1. Run the **Intel® Rapid Storage Technology** application.
2. Click **Enable acceleration** under **Performance > Smart Response Technology** (note that you will need at least 5MB of free unpartitioned and unallocated space on the SSD otherwise the Smart Response Technology item will not appear).

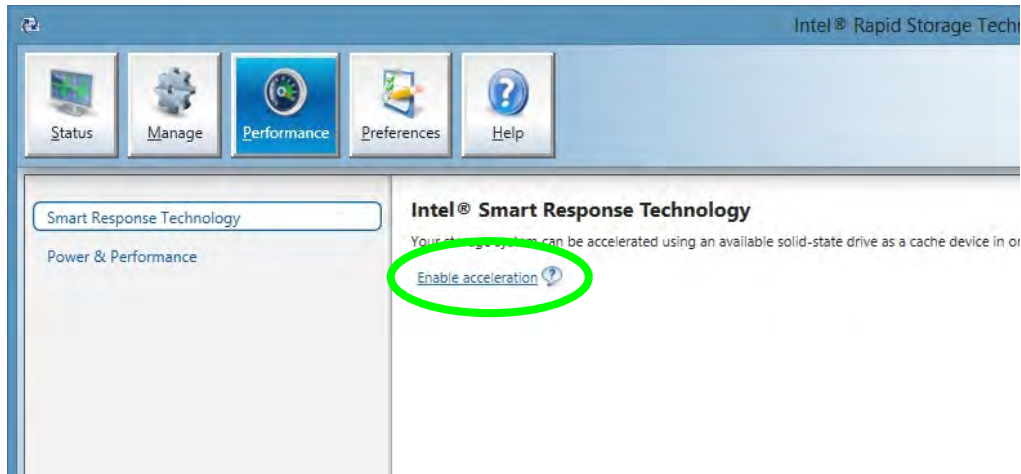

3. Select the SSD to be used as a cache device.
4. Select the size from the SSD to be allocated for the cache memory (any remaining space on the SSD can be used for data storage using the simple data single-disk RAID 0 volume that is automatically created).

Figure 7 - 74
Intel® Rapid
Storage
Technology -
Performance
Enable
Acceleration

5. Select the HDD (or RAID volume) to be accelerated (it is highly recommended that you accelerate the system volume or system disk for maximum performance).
6. Select the acceleration mode, and then click **OK** (Enhanced mode is selected by default).

Note: **Enhanced mode** (default): Acceleration optimized for data protection.

Maximized mode: Acceleration optimized for input/output performance.

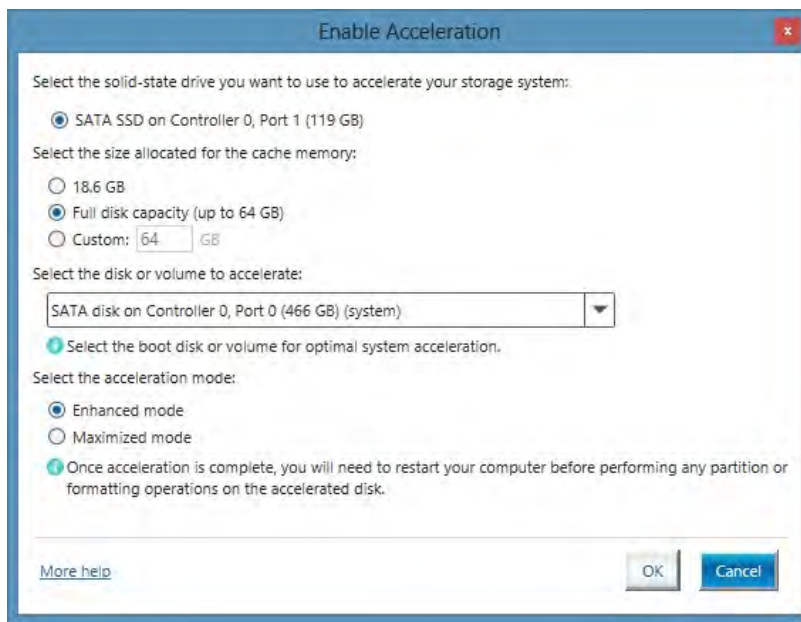

7
Figure 7 - 75
**Enable
Acceleration
Options**

- The page will refresh and report the new configuration in under **Performance > Smart Response Technology**.



Figure 7 - 76
Intel® Rapid Storage Technology - Performance (Smart Response Technology)

Intel® Rapid Start Technology Driver

Intel(R) Rapid Start Technology can resume power from Hibernation within 5 to 6 seconds and can remember your computer's previous state with zero power.

System Requirements to support Intel® Rapid Start Technology:

- Rapid Start Technology should be enabled in the BIOS (see “*“Intel(R) Rapid Start Technology (Advanced Menu)” on page 5 - 9*”).
- Intel Rapid Storage Technology software installed.
- A Solid State Drive (SSD) with a minimum capacity of 18.6GB.

See overleaf for instructions on enabling **Intel® Rapid Start Technology**.

Intel® Rapid Start Technology Configuration

1. Enable/disable Intel(R) Rapid Start Technology from the BIOS (see *“Intel(R) Rapid Start Technology (Advanced Menu)” on page 5 - 9*).
2. Go the **Windows** control panel and double-click **Administrative Tools (System and Security) > Computer Management > Storage > Disk Management**
3. Right-click the SSD and select **Shrink Volume** from the menu.

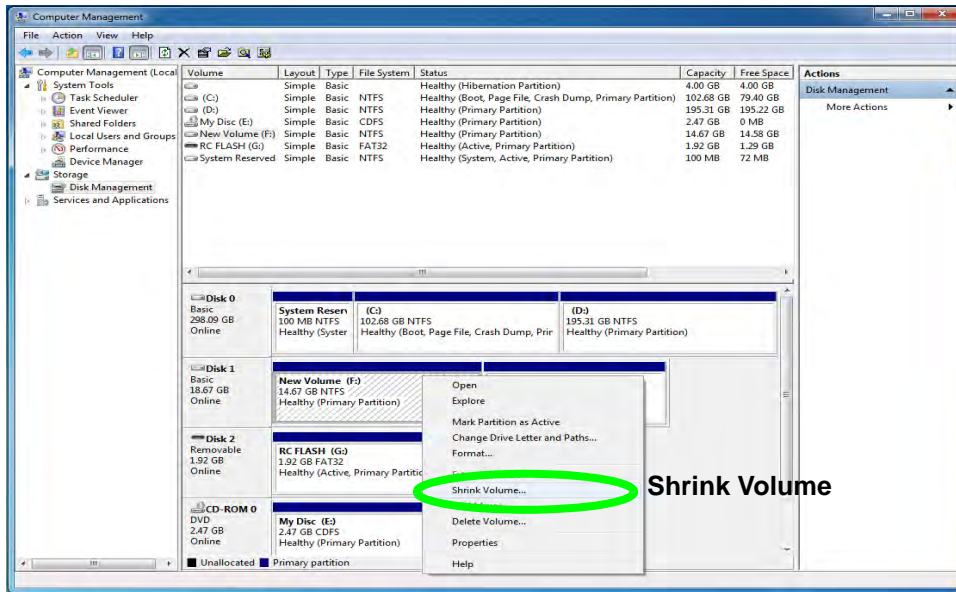
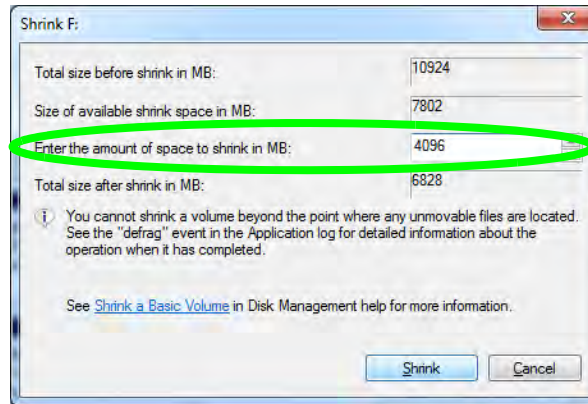

Figure 7 - 77
Computer Management (Shrink SSD Volume)

4. Enter the figure, **which should be equal to amount of system memory (RAM) in your computer**, in “Enter the amount of space to shrink in MB”.

Figure 7 - 78
**Shrink Volume
Size**



5. Click **Shrink** (any unallocated file space may be formatted for storage use).



Memory Size (Amount of Space to Shrink)

The figure entered in the “**Enter the amount of space to shrink in MB**” field above should be equal to the amount of system memory in your computer. In the example above the system memory is 4GB (**1024MB * 4 = 4096GB**). If you are unsure of your total system memory (RAM) then go to **System** control panel (System and Security) and check **Installed memory (RAM)**. The memory size will be displayed in GB so convert by multiplying the GB figure by 1024 to get the total in MB (e.g. 8GB = 8192MB).

- Run the Desktop app and right-click the lower left hot corner (or use the **Windows Logo Key** + X key combination) and select **Command Prompt (Admin)**.

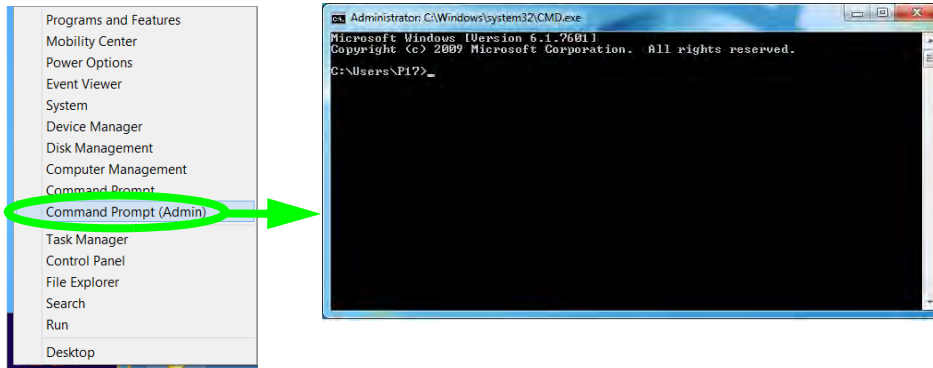

Figure 7 - 79
Search for CMD Prompt

- Type “**DISKPART**”.
- At the DISKPART command type “**list disk**”.



Figure 7 - 80
Diskpart - List Disk

9. Type **“select disk #”** (# is disk number where you want to create the store partition, so refer to the results obtained from **“list disk”** for exact disk number).
10. The message **“Disk # is now the selected disk.”** will appear.

Figure 7 - 81
Diskpart - Select
Disk #

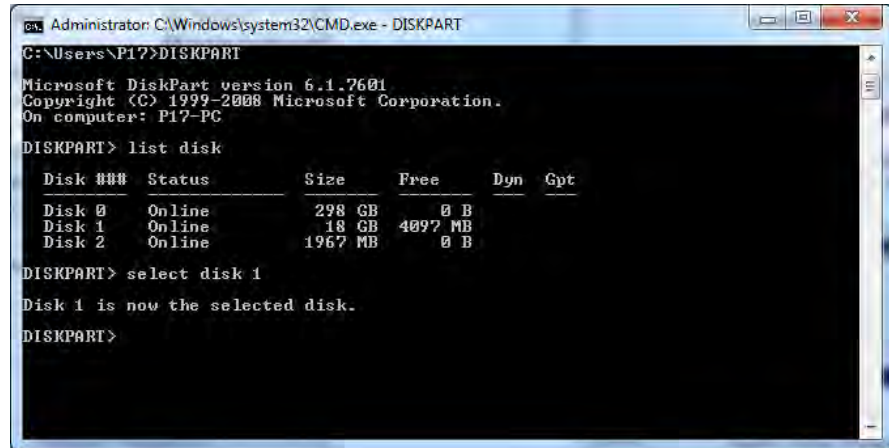

```
Administrator: C:\Windows\system32\CMD.exe - DISKPART
C:\Users\P17>DISKPART
Microsoft DiskPart version 6.1.7601
Copyright (C) 1999-2008 Microsoft Corporation.
On computer: P17-PC

DISKPART> list disk

   Disk ###  Status         Size           Free           Dyn  Gpt
   -----  -
   Disk 0    Online         298 GB         0 B
   Disk 1    Online         18 GB         4097 MB
   Disk 2    Online         1967 MB         0 B

DISKPART> select disk 1

Disk 1 is now the selected disk.

DISKPART>
```

11. Type **“create partition primary”**.
12. A **“DiskPart succeeded in creating the specified partition.”** message should appear.

Figure 7 - 82
Diskpart - Create
Partition

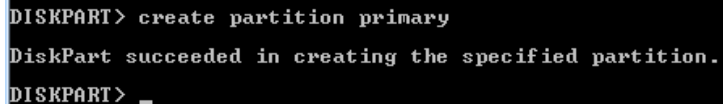

```
DISKPART> create partition primary
DiskPart succeeded in creating the specified partition.
DISKPART> _
```

13. Type “detail disk”.

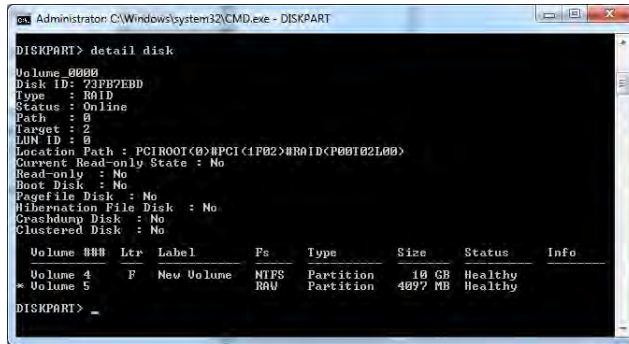

Figure 7 - 83
Diskpart - Detail
Disk

- 14. Type “select Volume #” (# is volume of your storage partition so refer to results obtained from "detail disk" for the exact volume number).
- 15. The message “Volume # is now the selected volume.” will appear.

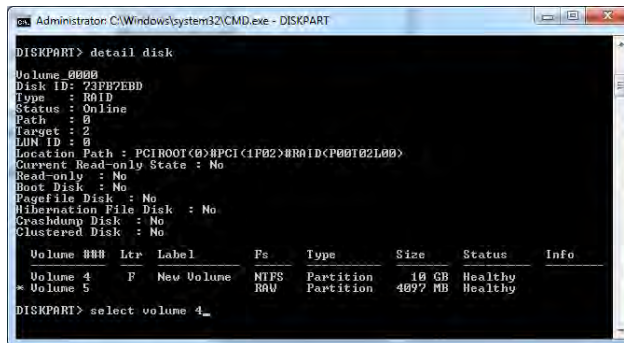

Figure 7 - 84
Diskpart - Select
Volume #

16. Type the following, depending on the format of the SSD.

- For **MBR** formatted SSDs: “set id=84 override” (the id must be set to 84).
- For **GPT** formatted SSDs: “set id=D3BFE2DE-3DAF-11DF-BA40-E3A556D89593”.

Figure 7 - 85
Diskpart - Set id=

```

Administrator: C:\Windows\system32\CMD.exe - DISKPART
Status : Online
Path : \
Target : 2
LUN ID : 0
Location Path : PCIROOT(0)#PCI(1F02)#RAID(P00T02L00)
Current Read-only State : No
Read-only : No
Boot Disk : No
Pagefile Disk : No
Hibernation File Disk : No
Crashdump Disk : No
Clustered Disk : No

  Volume ###  Ltr  Label             Fs          Type        Size         Status       Info
  -----
  Volume 4          F  New Volume       NTFS        Partition   10 GB        Healthy
 * Volume 5          \          RAW              Partition   4097 MB     Healthy

DISKPART> select volume 4

Volume 4 is the selected volume.

DISKPART> set id=84 override

DiskPart successfully set the partition ID.

DISKPART> _
  
```

17. The message “DiskPart successfully set the partition ID.” will appear.

18. Close the CMD window.

19. Go the **Windows** control panel and double-click **Administrative Tools (System and Security) > Computer Management > Storage > Disk Management**.
20. The disk partition should read **Healthy Hibernation Partition**.

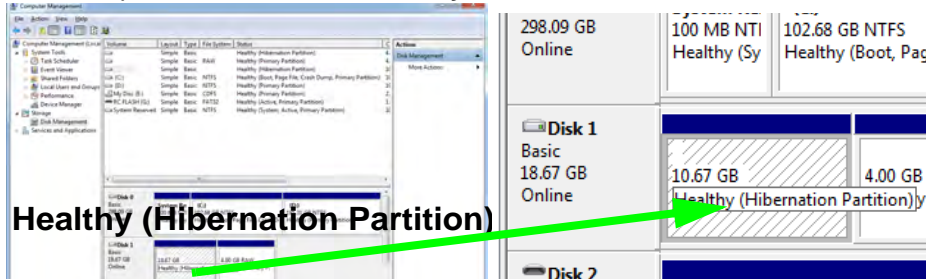

Figure 7 - 86
Computer Management (Healthy Hibernation Partition)

21. Restart the computer.
22. Install the driver (see below).

Intel® Rapid Start Technology Driver Installation

1. Insert the *Device Drivers & Utilities + User's Manual* disc into the CD/DVD drive.
2. Click **Option Drivers** (button).
3. Click **7.Install Rapid Start Driver > Yes**.
4. Click **Next > Next > Yes > Next > Next**.
5. Click **Finish** to restart the computer.

Chapter 8: Troubleshooting

Overview

Should you have any problems with your computer, before consulting your service representative, you may want to try to solve the problem yourself. This chapter lists some common problems and their possible solutions. This can't anticipate every problem, but you should check here before you panic. If you don't find the answer in these pages, make sure you have followed the instructions carefully and observed the safety precautions in the preface. If all else fails, talk to your service representative. You should also make a record of what happened and what remedies you tried.

Of course, if something goes wrong, it will happen at the most inconvenient time possible, so you should preview this section just in case. If, after you've tried everything, and the system still won't cooperate, try turning it off for a few minutes and then rebooting. You will lose any unsaved data, but it may start working again. Then call your service representative.

Basic Hints and Tips

Many of the following may seem obvious but they are often the solution to a problem when your computer appears not to be working.

- **Power** - Is the computer actually plugged into a working electrical outlet? If plugged into a **power strip**, make sure it is actually working. Check the **LED Power Indicators** (see *“LED Indicators” on page 1 - 11*) to see the computer’s power status.
- **Connections** - Check all the **cables** to make sure that there are no **loose connections** anywhere.
- **Power Savings** - Make sure that the system is not in **Hibernate** or **Sleep** mode by pressing the keys configured in your *Power Options* (see *“Configuring the Power Buttons” on page 3 - 8*), the **Fn + F4** key combination, or power button to wake-up the system.
- **Brightness** - Check the brightness of the screen by pressing the **Fn + F8 and F9** keys to adjust the brightness (see *Table 1 - 6, on page 1 - 19*).
- **Display Choice** - Press **Fn + F7** to make sure the system is not set to “external only” display.
- **Boot Drive** - Make sure there are no **optical media and/or USB storage devices** in any connected drive when you start up your machine (this is a common cause of the message *“Invalid system disk - Replace the disk, and then press any key” / “Remove disks or other media. Press any key to restart”*).

Backup and General Maintenance

- Always **backup** your important data, and keep copies of your OS and programs safe, but close to hand. Don't forget to note the **serial numbers** if you are storing them out of their original cases, e.g. in a CD wallet.
- Run **maintenance programs** on your hard disk and OS as often as you can. You may schedule these programs to run at times when you are not using your computer. You can use those that are provided free with your OS, or buy the more powerful dedicated programs to do so.
- Write down your passwords and keep them safe (away from your computer). This is especially important if you choose to use a **Boot** password for the SCU (see *“Security Menu” on page 5 - 12*).
- Keep copies of vital **settings files** such as network, dialup settings, mail settings etc. (even if just brief notes).



Warranty

The CPU is not a user serviceable part. Opening this compartment, or accessing the CPU in any way, may violate your warranty.

Viruses

- Install an **Anti-Virus** program and keep the **definitions file** (the file which tells your program which viruses to look for) up to date. New computer viruses are discovered daily, and some of them may seriously harm your computer and cause you to lose data. **Anti-Virus** programs are commercially available and the **definitions file updates** are usually downloadable directly from the internet.
- Be careful when opening e-mail from sources you don't know. **Viruses** are often triggered from within **e-mail attachments** so take care when opening any attached file. You can configure most **Anti-Virus** programs to check all **e-mail attachments**. **Note:** You should also beware of files from people you know as the virus may have infected an **address book** and been automatically forwarded without the person's knowledge.
- Keep a "**Bootable CD-ROM/DVD-ROM/USB storage device**" (this CD/DVD/USB device provides basic information which allows you to startup your computer) handy. You may refer to your OS's documentation for instructions on how to make one, and many **Anti-Virus** programs will also provide such a disk (or at least instructions on how to make one).

Upgrading and Adding New Hardware/Software

- Do not be tempted to make changes to your **Windows Registry** unless you are very sure of what you are doing, otherwise you will risk severely damaging your system.
- Don't open your computer or undertake any repair or upgrade work if you are not comfortable with what you are doing.
- Read the **documentation**. We can assume, since you are reading this that you are looking at the computer's manual, but what about any new peripheral devices you have just purchased? Many problems are caused by the installation of new hardware and/or software. Always refer to the documentation of any new hardware and/or software, and pay particular attention to files entitled "**READ ME**" or "**READ ME FIRST**".
- When installing a new device always make sure the device is powered on, and in many cases you will need to restart the computer. Always check that all the cables are correctly connected.
- Make sure you have installed the **drivers** for any new hardware you have installed (latest **driver files** are usually available to download from vendor's websites).
- Thoroughly check any **recent changes** you made to your system as these changes may affect one or more system components, or software programs. If possible, go back and undo the change you just made and see if the problem still occurs.

Troubleshooting

- Don't over complicate things. The less you have to deal with then the easier the source of the problem may be found; **Example** - if your computer has many devices plugged into its ports, and a number of programs running, then it will be difficult to determine the cause of a problem. Try disconnecting all of the devices and restarting the computer with all the peripheral devices unplugged. A process of elimination (adding and removing devices and restarting where necessary) will often find the source of a problem, although this may be time consuming.

Problems and Possible Solutions



| Problem | Possible Cause - Solution |
|--|--|
| <p>You turned on the power but it doesn't work.</p> | <p><i>Battery missing / incorrectly installed.</i> Check the battery bay, make sure the battery is present and seated properly (the design of the battery only allows it to go in one way). Make sure there's nothing interfering with the battery contacts.</p> |
| <p>The battery LED power indicator , is blinking orange.</p> | <p><i>Low Battery.</i> Plug in the DC power source. If the computer doesn't start up immediately, turn it off then on again.</p> |
| <p>You are losing battery power too quickly.</p> | <p><i>The system is using too much power.</i> If your OS has a <i>Power Options</i> scheme (see "Power Plans" on page 3 - 4) check its settings. You may also be using a <i>peripheral device/USB device</i> that is drawing a lot of power.</p> |
| <p>Actual battery operating time is shorter than expected.</p> | <p><i>The battery has not been fully discharged before being recharged.</i> Make sure the battery is fully discharged and recharge it completely before reusing (see "Battery Information" on page 3 - 13).</p> <p><i>Power Options have been disabled.</i> Go to the Control Panel in <i>Windows</i> and re-enable the options.</p> <p><i>A peripheral device/USB device is consuming a lot of power.</i> Turn off/remove the unused device to save power.</p> |

Troubleshooting

| Problem | Possible Cause - Solution |
|---|---|
| The computer feels too hot . | <p>Make sure the computer is properly ventilated and the Vent/Fan intakes are not blocked. If this doesn't cool it down, put the system into Hibernate mode or turn it off for an hour. Make sure the computer isn't sitting on a thermal surface (see "Overheating" on page 1 - 26/1 - 27). Make sure you're using the correct adapter.</p> <p>Make sure that your notebook is completely powered off before putting it into a travel bag (or any such container). Putting a notebook which is powered on in a travel bag may cause the Vent/Fan intakes to be blocked.</p> |
| Nothing appears on screen. | <p><i>The system is in a power saving mode.</i> Toggle the sleep/resume key combination, Fn + F4 (see "Configuring the Power Buttons" on page 3 - 8).</p> <p><i>The screen controls need to be adjusted.</i> Toggle the screen control key combinations Fn + F8/F9. If you're connected to an external monitor, make sure it's plugged in and turned on. You should also check the monitor's own brightness and contrast controls.</p> <p><i>The computer is set for a different display.</i> Toggle the screen display key combination, Fn + F7. If an external monitor is connected, turn it on.</p> <p><i>The screen saver is activated.</i> Press any key or touch the TouchPad.</p> |
| No image appears on the external monitor I have plugged in and powered on. | <p><i>You haven't installed the video driver and configured it appropriately from the Control Panel.</i> See Appendix C for instructions on installing and configuring the video driver.</p> |

| Problem | Possible Cause - Solution |
|---|--|
| You forget the boot password . | <i>If you forget the password, you may have to discharge the battery of the CMOS. Contact your service representative for help.</i> |
|  <p>Password Warning</p> <p>If you choose to set a boot password, NEVER forget your password. The consequences of this could be serious. If you cannot remember your boot password you must contact your vendor and you may lose all of the information on your hard disk.</p> | |
| The CD/DVD cannot be read . | <i>The CD/DVD is dirty. Clean it with a CD/DVD cleaner kit.</i> |
| The DVD tray will not open when there is a disc in the tray. | <i>The DVD is not correctly placed in the tray. Gently try to remove the disc using the eject hole (see “Loading Discs” on page 2 - 3).</i> |
| The DVD regional codes can no longer be changed. | <i>The code has been changed the maximum 5 times. See “DVD Regional Codes” on page 2 - 5.</i> |
| Unwelcome numbers appear when typing. | <i>Num Lock is turned ON (see “LED Indicators” on page 1 - 11).</i> |

Troubleshooting

| Problem | Possible Cause - Solution |
|--|---|
|  <h3>Other Keyboards</h3> <p>If your keyboard is damaged or you just want to make a change, you can use any standard USB keyboard. The system will detect and enable it automatically. However special functions/hot keys unique to the system's regular keyboard may not work.</p> | |
| <p>The system freezes or the screen goes dark.</p> | <p><i>The system's power saving features have timed-out.</i> Use the AC/DC adapter, press the sleep (Fn + F4) key combination, or press the power button if no LEDs are lit.</p> |
| <p>The system never goes into a power saving mode.</p> | <p>Power Options features are not enabled. Go to the Windows Power Options menu and enable the features you prefer (see <i>"Power-Saving States" on page 3 - 6</i>). Make sure you have enabled Hibernate mode from the control panel.</p> |
| <p>The Wireless LAN/Bluetooth modules cannot be detected.</p> | <p><i>The modules are off as the computer is in Airplane Mode.</i> Check the LED indicator  to see if it is in Airplane Mode (see <i>"LED Indicators" on page 1 - 11</i>). Use the Fn + F11 key combination to toggle Airplane Mode on/off.</p> |
| <p>The PC Camera module cannot be detected.</p> | <p><i>The module is off.</i> Press the Fn + F10 key combination in order to enable the module (see <i>"Function Keys & Visual Indicators" on page 1 - 19</i>). Run the camera application to view the camera picture.</p> |

| Problem | Possible Cause - Solution |
|--|--|
| The Wireless LAN/Bluetooth modules cannot be configured. | The driver(s) for the module(s) have not been installed. Make sure you have installed the driver for the appropriate module (see the instructions for the appropriate module in <i>“Wireless LAN Module” on page 7 - 19</i> and/or <i>“BioExcess Application” on page 7 - 46</i>). |
| A file cannot be copied to/from a connected Bluetooth device. | <i>The transfer of data between the computer and a Bluetooth enabled device is supported in one direction only (simultaneous data transfer is not supported).</i> If you are copying a file from your computer to a Bluetooth enabled device, you will not be able to copy a file from the Bluetooth enabled device to your computer until the file transfer process has been completed |
| I cannot obtain high speed Bluetooth data transfer. | <i>To obtain high speed Bluetooth data transfer take into account the following:</i> <ul style="list-style-type: none"> • To achieve high speed transfer speeds, both devices must support high speed data transfer (i.e both the computer and the Bluetooth compatible device you are connecting to). • Check your Bluetooth compatible device’s documentation to confirm it supports high speed data transfer, and for configuration information. |
| The sound cannot be heard or the volume is very low . | <i>The volume might be set too low.</i> Check the volume control in the Volume Control Panel in the taskbar notification area, or use the key combination Fn + F5 & F6 (see <i>“Function Keys & Visual Indicators” on page 1 - 19</i>) to adjust. |
| The fingerprint reader has problems scanning fingers . | <i>When fingers are wet or sweaty the software application may have difficulty reading a scanned finger.</i> Make sure your fingers are clean and dry when attempting to scan them across the sensor for detection. |

Troubleshooting

| Problem | Possible Cause - Solution |
|--|---|
| <p>The computer is off (or in Sleep Mode) but powered by the AC/DC adapter plugged in to a working outlet, or by battery with a capacity above 20%. I have plugged a device into the powered USB port in order to charge it, but the device is not charging.</p> | <p><i>The port is not powered on.</i> Toggle power to the port using the Fn + power button combination.</p> <p><i>This function may not work with certain external USB compliant devices (check your device's documentation).</i> If this is the case, power the computer on and connect the external USB device in order to charge it.</p> <p>Note that this function is designed to help charge USB compliant devices, but is not designed to allow their operation.</p> |
| <p>No sound can be heard through an HDMI connected display.</p> | <p><i>You have not configured the HDMI audio output.</i> See “HDMI Audio Configuration” on page C - 17.</p> |
| <p>Audio Volume is too low when listening through headphones.</p> | <p><i>You have set the Speaker Configuration to 5.1 or 7.1 Speaker.</i> It is recommended that you set the Speaker Configuration to Stereo (not to 5.1 or 7.1 Speaker) when listening through headphones in order to maximize audio quality. See “Audio Features” on page 2 - 7.</p> |
| <p>The Sound Blaster audio controls don't work when the system is connected to an external display through an HDMI cable.</p> | <p><i>Note that Sound Blaster Audio will be disabled when you are connecting to an external display through an HDMI connection.</i> See “Sound Blaster Audio & HDMI” on page 7 - 85.</p> |
| <p>The volume bar LED does not oscillate.</p> | <p><i>Note that the volume bar LED will not oscillate if the volume level is set lower than 20%.</i> Adjust the system audio to a level above 20% if you want to view the volume bar LED effect.</p> |

| Problem | Possible Cause - Solution |
|--|---|
| <p>I have connected a Bluetooth Mouse but it loses the Bluetooth connection and no longer responds after a short period of inactivity.</p> | <p><i>This is an issue with this mouse model and the Intel Wireless 7260 WLAN and Bluetooth combo module series. To resolve this issue do the following:</i></p> <ol style="list-style-type: none"> 1. Go to the Device Manager control panel in Windows. 2. Click the arrow alongside Bluetooth to expand the menu if required. 3. Double-click Intel(R) Wireless Bluetooth(R) 4.0 + HS Adapter. 4. Click the Power Management tab. 5. Make sure that the tickbox alongside “allow the computer to turn off this device to save power” doesn’t have a tick alongside it. 6. Click OK and close the control panel. |

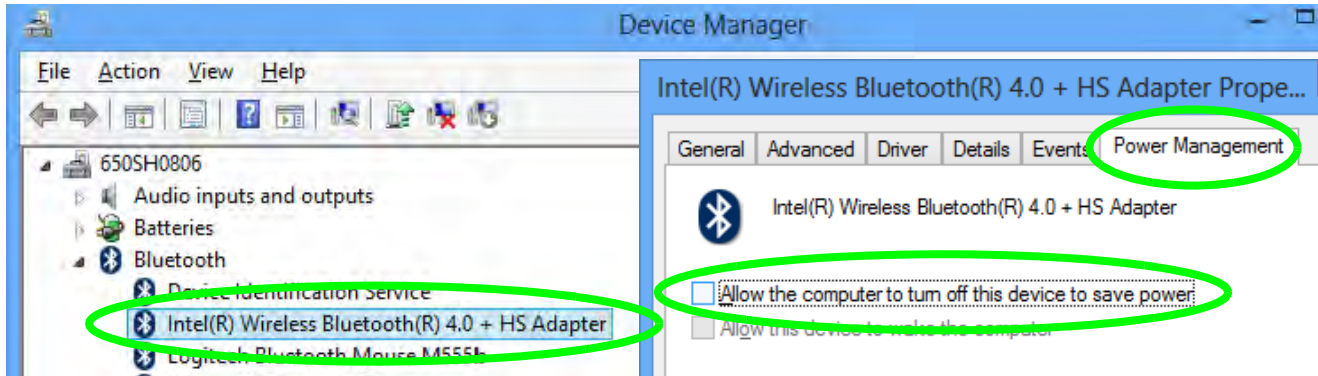

Figure 8 - 1 - Device Manager (Bluetooth)

Changing The SATA Mode

The SATA mode can be set operate in **IDE** (native/compatible), **AHCI** (Advanced Host Controller Interface) or **RAID** (Redundant Array of Independent Disks) modes, and needs to be done so before installing your operating system.

If you wish to change your SATA mode to/from AHCI/RAID/IDE mode you will receive a message (see below) to notify you that doing so may prevent your operating system from booting, and may require a reinstall of the OS. If you do wish to change the SATA mode then backup any necessary data required on your hard disk(s) as **you will need to clean all data on the disks** in order to prevent system problems.

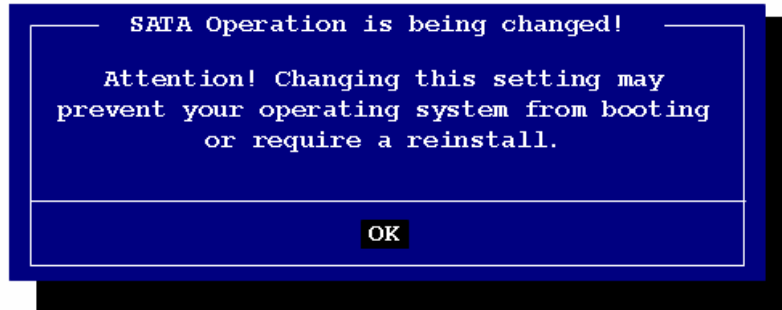

Figure 8 - 2 - SATA Mode Change Notification

For instructions on cleaning all the data from your disks see the appropriate pages listed below:

- *“Changing the System from AHCI or IDE Mode to RAID Mode” on page 8 - 15.*
- *“Changing the System from RAID to AHCI Mode to IDE Mode” on page 8 - 21.*

Changing the System from AHCI or IDE Mode to RAID Mode

1. Go to the operable computer and insert a USB Flash drive or external USB HDD.
2. Insert the **Device Drivers & Utilities + User's Manual** disc into the CD/DVD drive of the operable computer.
3. Copy the **f6flpy-x64** folder from the location below (D: denotes your DVD drive) on the **Device Drivers & Utilities + User's Manual** disc to the USB flash drive or external USB hard disk.
 - **Windows 8 64bit = D:\Options\00_IRST\f6flpy\f6flpy-x64**
4. Start-up your notebook computer and press <F2> to enter the **BIOS**.
5. Go to the **Boot** menu, select **UEFI Setting** and press <Enter> (see page 5 - 17).
6. Set **UEFI Boot** to "Enabled".
7. Press <Esc> to exit the menu and go to the **Advanced** menu.
8. Select **SATA Mode** (see page 5 - 10), press <Enter> and select "RAID Mode".
9. You will then receive the warning message (see **Figure 8 - 2 on page 8 - 14**) that changing the SATA mode will result in needing to reinstall the operating system; press **OK** to confirm the change.
10. Press <F4> and <Yes> to "Save Changes and Reset".
11. After computer restarts press <F2> to enter the **BIOS** again.
12. Go to **Intel(R) Rapid Storage Technology** (in the **Advanced** menu) and press <Enter>.
13. Select **Create RAID Volume** and press <Enter>.

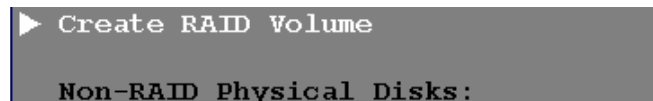

Figure 8 - 3 - Create RAID Volume (Advanced > Intel(R) Rapid Storage Technology)

Troubleshooting

14. You can now setup your RAID volume using any two installed disks.
15. Go to **Name:** and press <Enter>.
16. Type a name of your choice for your RAID volume and press <Enter>.

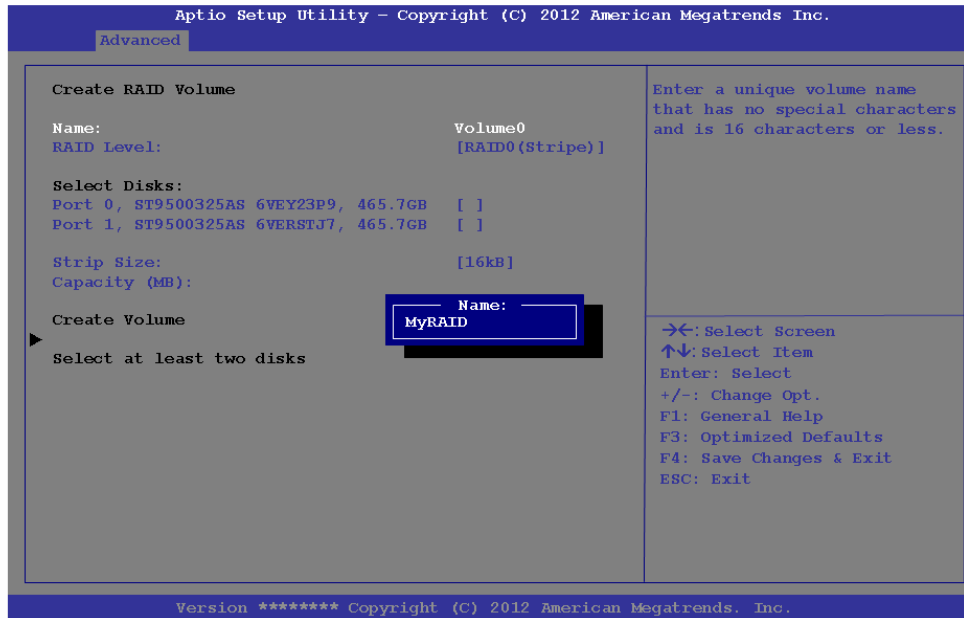

Figure 8 - 4 - Name the RAID Volume (Advanced > Intel(R) Rapid Storage Technology)

17. Go to **RAID Level:** and press <Enter>.
18. Choose the RAID Level required (see [Table 7 - 1, on page 7 - 3](#) for details) and press <Enter>.
 - **RAID0 (Stripe)**
 - **RAID1 (Mirror)**
 - **Recovery**
19. Go to any of the disks listed under **Select Disks:** and select a disk name and press <Enter>.
20. Move the cursor down (use the arrow keys) onto to **X** (o select the disk required and press <Enter>.
 - If you have selected a **Recovery** level RAID then you need to select one disk to be **Master disk (M)** and one disk to be the **Recovery disk (R)**



Figure 8 - 5 - Select Disks (Advanced > Intel(R) Rapid Storage Technology)

Troubleshooting

21. You should select two identical disks to form your RAID volume.
22. If you have selected **RAID0 (Stripe)** then you can adjust the “**Strip Size**” to your requirements.
23. If you have selected **Recovery** then you can adjust the **Synchronization** to “**On Request**” or “**Continuous**”.
24. Go to **Create Volume** and press <Enter>.
25. The RAID volume will then be created and the RAID information will be displayed under **Intel(R) Rapid Storage Technology** (in the **Advanced** menu).

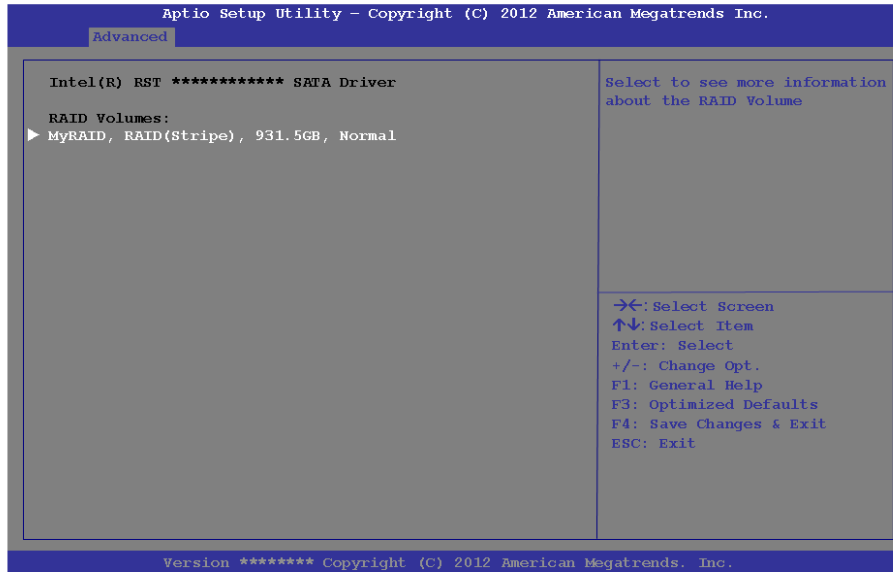

Figure 8 - 6 - Created RAID Information (Advanced > Intel(R) Rapid Storage Technology)

26. Press <Esc> to exit the menu.
27. Press <F4> and <Yes> to “**Save Changes and Reset**”, however **ensure that the two conditions in the bulleted points below are met** before doing so.
 - Make sure the *Windows 8* OS DVD is in the DVD drive, as the computer starts up it will automatically boot from the *Windows 8* OS DVD (you will be prompted to press a key to boot from the DVD).
 - Make sure your USB Flash drive or external USB hard disk is attached to one of the USB ports on the computer.
28. Press <F7> as the computer starts up to bring up the boot device menu.
29. Select the DVD drive containing the *Windows 8* OS DVD and press <Enter>.
30. Press a key at system startup to begin installing *Windows* from your *Microsoft Windows 8* disc.
31. Click **Next > Install Now** to continue installing the operating system.
32. When the *Windows* system prompts you for “*Which type of installation do you want?*” press the **Shift + F10** keys.
33. When the command prompt pops up type “**diskpart**” and press <Enter>.
34. Type “**list disk**” and press <Enter> (a list of installed hard disk drives will appear with a number listed after them).

```

DISKPART> list disk

   Disk ###  Status         Size           Free           Dyn    Gpt
   -----  -
   Disk 0    Online          119 GB         21 GB          *

DISKPART> select disk 0

Disk 0 is now the selected disk.

DISKPART> clean
  
```

Figure 8 - 7 - Diskpart

Troubleshooting

35. Type “**select disk #**” (the # is the number of the disk you wish to select and you will need to repeat the procedure for any of your installed disks) and press <Enter>.
36. The system will then prompt “**Disk # is now the selected disk**”.
37. Type “**clean**” and press <Enter>.
38. The system will then clean the data from the selected disk.
39. Repeat the procedure for any other installed disks (type select disk # for any other disks).
40. After all the installed disks have been cleaned type “**exit**” to close diskpart.
41. Proceed with the **Windows** installation procedure (see your **Windows** documentation if you need help on installing the **Windows** OS).
42. A prompt will appear to ask you to **Load Driver**.
43. Click **Browse** and browse to the location you copied the files to on your USB Flash drive or external USB hard disk (X: denotes your USB Flash drive or external USB hard disk):
 - **X:\f6flpy-x64 (Windows 8 64bit)**
44. Click **Next**.
45. Follow the on-screen instructions to install the **Windows 8** operating system.
46. Install the **Windows** drivers from the **Device Drivers & Utilities + User’s Manual** disc as per **Table 4 - 1, on page 4 - 3** (make sure you install the Intel Rapid Storage Technology driver - see overleaf).
47. Run the **Intel® Rapid Storage Technology** application to manage your RAID volume as instructed in “**Intel® Rapid Storage Technology for RAID Systems**” on page 7 - 87.

Changing the System from RAID to AHCI Mode to IDE Mode

If you wish to change from a RAID mode to AHCI or IDE modes you will need to delete any existing RAID by following the procedure below. However **backup up any necessary files and data before deleting a RAID**, as doing so will result in the loss of all data on the RAID volumes.

1. Start-up your notebook computer and press <F2> to enter the **BIOS**.
2. Go to **Intel(R) Rapid Storage Technology** (in the **Advanced** menu) and press <Enter>.
3. Go to the RAID (listed under **RAID Volumes:**) and press <Enter>.
4. Select **Delete** and press <Enter>.
5. Select **“Yes”** (note that all the data on the volumes will be lost) and press <Enter>.

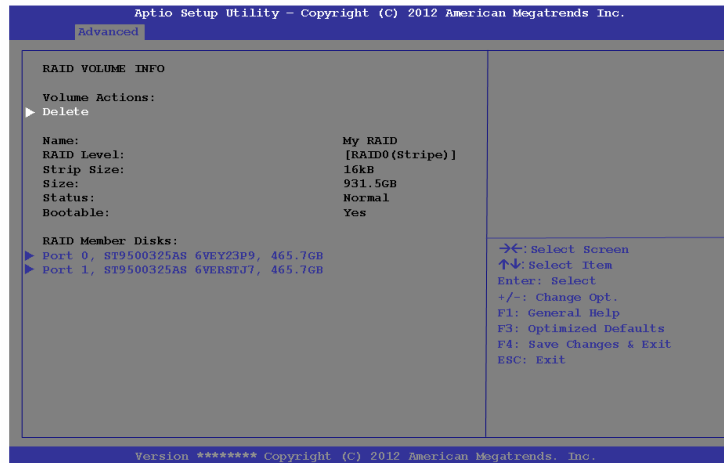

Figure 8 - 8 - Delete RAID (Advanced > Intel(R) Rapid Storage Technology)

Troubleshooting

- Start-up your notebook computer and press <F2> to enter the **BIOS**.
- Go to the **Boot** menu, select **UEFI Setting** and press <Enter> (see page 5 - 17).
- Set **UEFI Boot** to “**Enabled**”.
- Press <Esc> to exit the menu and go to the **Advanced** menu.
- Select **SATA Mode** (see page 5 - 10), press <Enter> and select “**AHCI Mode**” or “**RAID Mode**”.
- You will then receive the warning message (see *Figure 8 - 2 on page 8 - 14*) that changing the SATA mode will result in needing to reinstall the operating system; press **OK** to confirm the change.
- Press <F4> and <Yes> to “**Save Changes and Reset**”, however make sure that the **Windows 8** OS DVD is in the DVD drive, as the computer starts up it will automatically boot from the **Windows 8** OS DVD (you will be prompted to press a key to boot from the DVD).
- Press <F7> as the computer starts up to bring up the boot device menu.
- Select the DVD drive containing the **Windows 8** OS DVD and press <Enter>.
- Press a key at system startup to begin installing **Windows** from your **Microsoft Windows 8** disc.
- Click **Next > Install Now** to continue installing the operating system.
- When the **Windows** system prompts you for “**Which type of installation do you want?**” press the **Shift + F10** keys.
- When the command prompt pops up type “**diskpart**” and press <Enter.>
- Type “**list disk**” and press <Enter> (a list of installed hard disk drives will appear with a number listed after them).

```
DISKPART> list disk

  Disk ###  Status         Size           Free           Dyn    Gpt
  -----  -
  Disk 0    Online          119 GB         21 GB

DISKPART> select disk 0
Disk 0 is now the selected disk.

DISKPART> clean
```

Figure 8 - 9 - Diskpart





20. Type “**select disk #**” (the # is the number of the disk you wish to select and you will need to repeat the procedure for any of your installed disks) and press <Enter>.
21. The system will then prompt “**Disk # is now the selected disk**”.
22. Type “**clean**” and press <Enter>.
23. The system will then clean the data from the selected disk.
24. Repeat the procedure for any other installed disks (type select disk # for any other disks).
25. After all the installed disks have been cleaned type “**exit**” to close diskpart.
26. Proceed with the **Windows** installation procedure (see your **Windows** documentation if you need help on installing the **Windows** OS).
27. Install the **Windows** drivers from the **Device Drivers & Utilities + User’s Manual** disc as per [Table 4 - 1, on page 4 - 3](#) (make sure you install the Intel Rapid Storage Technology driver).

Appendix A: Interface (Ports & Jacks)





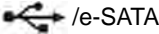

Overview

The following chapter will give a quick description of the ports & jacks which allow your computer to communicate with external devices, connect to the internet etc.



Ports and Jacks

| Item | Description |
|--|--|
| <p>Card Reader</p>  | <p>The card reader allows you to use the following digital storage cards:</p> <p style="text-align: center;">MMC (MultiMedia Card) / RSMMC SD (Secure Digital) / Mini SD / SDHC / SDXC MS (Memory Stick) / MS Pro / MS Duo</p> <p>Push the card into the slot and it will appear as a removable device.</p> |
| <p>DC-In Jack</p>  | <p>Plug the supplied AC/DC adapter into this jack to power your computer.</p> |
| <p>e-SATA/USB 2.0 Port</p>  | <p>This is a combined e-SATA (external Serial Advanced Technology Attachment)/ USB 2.0 compatible port.</p> <p>Plug external Serial ATA hard drives into this e-SATA (external Serial Advanced Technology Attachment) port. *See <i>“USB 3.0 Port” on page A - 5</i> for further USB port information.</p> |
| <p>HDMI-Out Port</p>  | <p>The HDMI-Out (High-Definition Multimedia Interface) port is an audio/video connector interface for transmitting uncompressed digital streams. This allows you to connect an external monitor, TV or Flat Panel Display etc. as a display device (see <i>“Configuring an External Display (NVIDIA)” on page C - 6</i>) by means of a HDMI cable. Note that HDMI carries both audio and video signals (see <i>“HDMI Audio Configuration” on page C - 17</i>).</p> |

Interface (Ports & Jacks)

| Item | Description |
|---|--|
| Headphone-Out Jack  | Headphones or speakers may be connected through this jack. Note: Set your system's volume to a reduced level before connecting to this jack. |
| Line-In Jack  | The Line-In jack allows you to play audio sources through the computer's speakers. Note that audio input through Line-in will default to the mute setting. To set up your audio sources to play through the Line-in jack go to the Sound control panel and make sure the Mute box is not ticked. |
| Microphone-In Jack  | Plug an external microphone in to this jack to record on your computer. |
| RJ-45 LAN Jack  | This port supports LAN (Network) functions. Note: Broadband (e.g. ADSL) modems usually connect to the LAN port. |
| S/PDIF-Out Jack  | This S/PDIF (Sony/Philips Digital Interface Format) Out Port allows you to connect your DVD-capable PC to a Dolby AC-3 compatible receiver for "5.1" or 'dts' surround sound. |
| Security Lock Slot  | To prevent possible theft, a Kensington-type lock can be attached to this slot. Locks can be purchased at any computer store. |

Interface (Ports & Jacks)

| Item | Description |
|---|--|
| <p>Thunderbolt Port</p>  | <p>The Thunderbolt port allows for the connection of external peripherals to the computer by combining PCI Express (PCIe) and DisplayPort (DP) technologies. Up to seven peripherals may be supported by one connector by daisy-chaining the devices. Devices supported include HDDs/SSDs, Audio Interfaces, docks, display devices, cameras etc.</p> <p>Install the driver as instructed in “Thunderbolt Port” on page 4 - 7. This will install the Thunderbolt software to your computer, and this can be accessed by clicking or double-clicking the icon  in the Start screen, Desktop app or notification area of the taskbar.</p> <ol style="list-style-type: none">1. Plug a Thunderbolt device into the Thunderbolt port.2. Some Thunderbolt devices will require their own driver installation at this point.3. Access the Thunderbolt software to view information on device chains. |

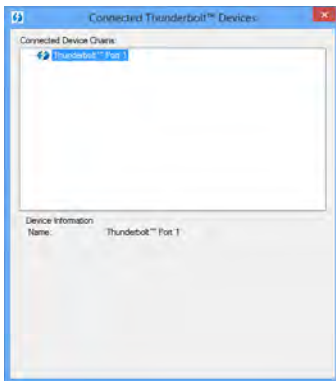

Ejecting Thunderbolt Devices

In order to prevent system problems make sure you **do not simply pull the cable out from the Thunderbolt port**. The hardware must be ejected safely:

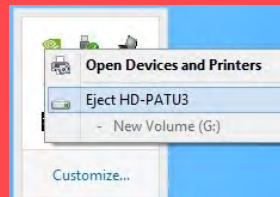

1. Go to the notification area of the taskbar in the Desktop App and click on the **Safely Remove Hardware and Eject Media** icon.
2. Click on Eject **“Thunderbolt Device Name”**.
3. When you see the **“Safe to Remove Hardware”** message you can remove the cable.

A

| Item | Description |
|--|--|
| <p>USB Ports</p> <p>USB 3.0 Port</p>  | <p>USB (Universal Serial Bus) compatible ports are for low-speed peripherals such as keyboards, mice or scanners, and for high-speed peripherals such as external HDDs, digital video cameras or high-speed scanners etc. Devices can be plugged into the computer, and unplugged from the computer, without the need to turn the system off (if the power rating of your USB device is 500mA or above, make sure you use the power supply which comes with the device).</p> <p>USB 3.0 ports on the computer are denoted by their blue color. USB 3.0 will transfer data much faster than USB 2.0, and is backwards-compatible with USB 2.0. The combined e-SATA/USB 2.0 port functions as a USB 2.0 compatible port.</p> <p>Note: The powered USB 3.0 port (see “Right View” on page 1 - 23) may be toggled on /off by means of the Fn + Power Button key combination (press for around 1 to 2 seconds to toggle). When the powered USB port is on it will supply power (for charging devices only, not for operating devices) when the system is off but still powered by the AC/DC adapter plugged into a working outlet, or powered by the battery with a capacity level above 20% (this may not work with certain devices - see page 8 - 12).</p> <p>Note: This function is designed to help charge USB compliant devices, but is not designed to allow their operation.</p> |

Interface (Ports & Jacks)

A

Appendix B: Control Center

Overview

The following chapter will give a quick description of the functions of the **Control Center**. The **Control Center** gives quick access to frequently used controls, power management features and enables you to quickly turn modules on/off. Click the **Control Center** icons to toggle the appropriate function, or hold the mouse button down and move the slider where applicable. Certain functions will automatically be adjusted when a power mode is selected. The **Control Center** in *Windows 8* works under the **Desktop** app and not under the Start screen.



Figure B - 1 - Control Center

Control Center

Power Modes

You can set a **Power Mode** by clicking the appropriate icon at the top of the **Control Center**. Each power mode will affect screen brightness, Touchpad and PC camera power etc.

You can click a **Control Center** icon to set an overall power mode and then click individual icons in the **Control Center** to power on/off the Touchpad and PC camera.









| Modes | | Power Saving | Entertainment | Quiet | Performance | User Defined |
|-------------------------|---|---|---|--|---|---|
| Icon | |  |  |  |  |  |
| Power Plan | | Power Saver | Power Saving | Power Saving | High Performance | User Defined |
| Power Conservation Mode | | Energy Star | Energy Star | Energy Star | Performance | |
| Brightness |  | 10 | 100 | 40 | 100 | |
| PC Camera |  | OFF | OFF | ON | ON | |
| TouchPad |  | ON | ON | ON | ON | |

Table B - 1- Power Modes

Power Status

The **Power Status** icon will show whether you are currently powered by the battery, or by the AC/DC adapter plugged in to a working power outlet. The power status bar will show the current battery charge state.

Brightness

The **Brightness** icon will show the current screen brightness level. You can use the slider to adjust the screen brightness or the **Fn + F8/F9** key combinations, or use the **Fn+ F2** key combination to turn off the LED backlight (press any key to turn it on again). Note that screen brightness is also effected by the **Power Mode** selected (see [Table B - 1, on page B - 2](#)).

Volume

The **Volume** icon will show the current volume level. You can use the slider to adjust the Volume or the **Fn + F5/F6** key combinations, or use the **Fn+ F3** key combination to mute the volume.



Power Conservation

This system supports **Energy Star** power management features that place computers (CPU, hard drive, etc.) into a low-power sleep modes after a designated period of inactivity (see [“Power Conservation Modes” on page 3 - 11](#)). Click either the **Performance**, **Balanced** or **Energy Star** button.



Control Center

Sleep

Click the **Sleep** button to bring up the **Hibernate**  or **Sleep**  buttons, and click either button to have the computer enter the appropriate power-saving mode (see *“Power-Saving States” on page 3 - 6*).

Display Switch

Click the **Display Switch** button to access the menu (or use the  + **P** key combination) and select the appropriate attached display mode.

Time Zone

Clicking the **Time Zone** button will access the **Date and Time Windows** control panel.

Desktop Background

Clicking the **Desktop Background** button will allow you to change the desktop background picture.

TouchPad/PC Camera

Click either of these buttons to toggle the TouchPad or camera module's power status. A crossed out icon will appear over the top left of the icon  when it is off. Note that the power status of the camera module is also effected by the **Power Mode** selected (see *Table B - 1, on page B - 2*).

Caps Lock/Scroll Lock/ Number Lock

Click the button to toggle the appropriate lock mode.

Appendix C: NVIDIA Video Driver Controls

The basic settings for configuring the LCD are outlined in *“Video Features” on page 1 - 39*.

NVIDIA Video Driver Installation

Make sure you install the drivers in the order indicated in *Table 4 - 1, on page 4 - 3*.

1. Insert the *Device Drivers & Utilities + User’s Manual* disc and click **Install Drivers** (button).
2. Click **2.Install VGA Driver > Yes**.
3. Click **AGREE AND CONTINUE** (button) to accept the terms of the license agreement.
4. Click **Next**.
5. Click the **Close** button to complete the installation.



Video Card Options

Note that card types, specifications and drivers are subject to continual updates and changes. Check with your distributor/supplier for the latest details on video cards supported (see *“Video Adapter” on page E - 2*).



NVIDIA Control Panel

To access the **GeForce.....** control panel from the desktop; right-click the **desktop**, then click **NVIDIA Control Panel**.

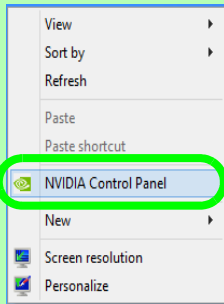
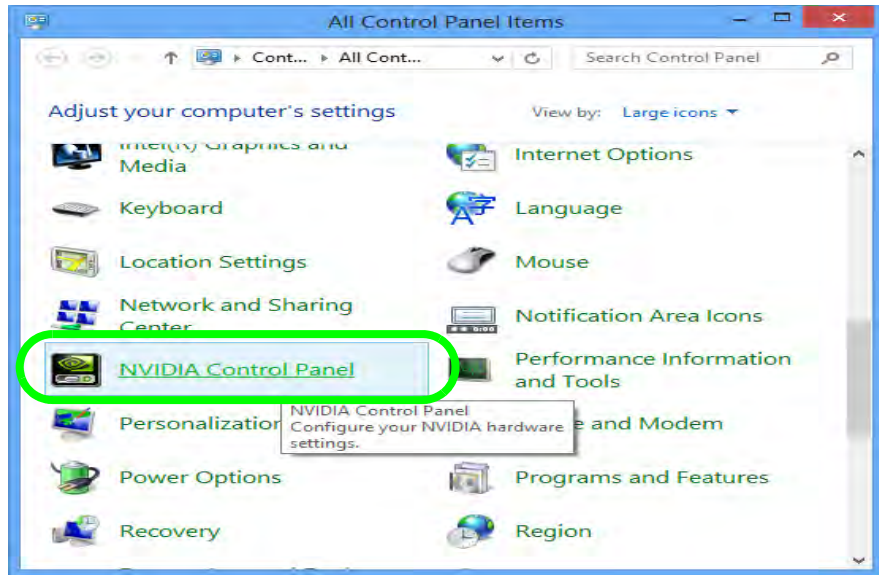

Figure C - 1
NVIDIA Control Panel

NVIDIA Control Panel

More advanced video configuration options are provided in the **NVIDIA Control Panel** tab.

1. Go to the **Control Panel**.
2. Double-click **NVIDIA Control Panel** (click to view the control panel in either **Large icons** or **Small icons** if you are in **Category** view).



The **NVIDIA Control Panel** provides additional video configuration controls and tools which allow quick access to features such as display configuration, 3D Settings and Help menus etc.



Navigating the Control Panel

Navigate through the control panels in much the same way as you would a web page. Click on the sub-headed tasks in the left menu (and on the highlighted links) for information. Use the buttons on the top left to go back, forward etc.

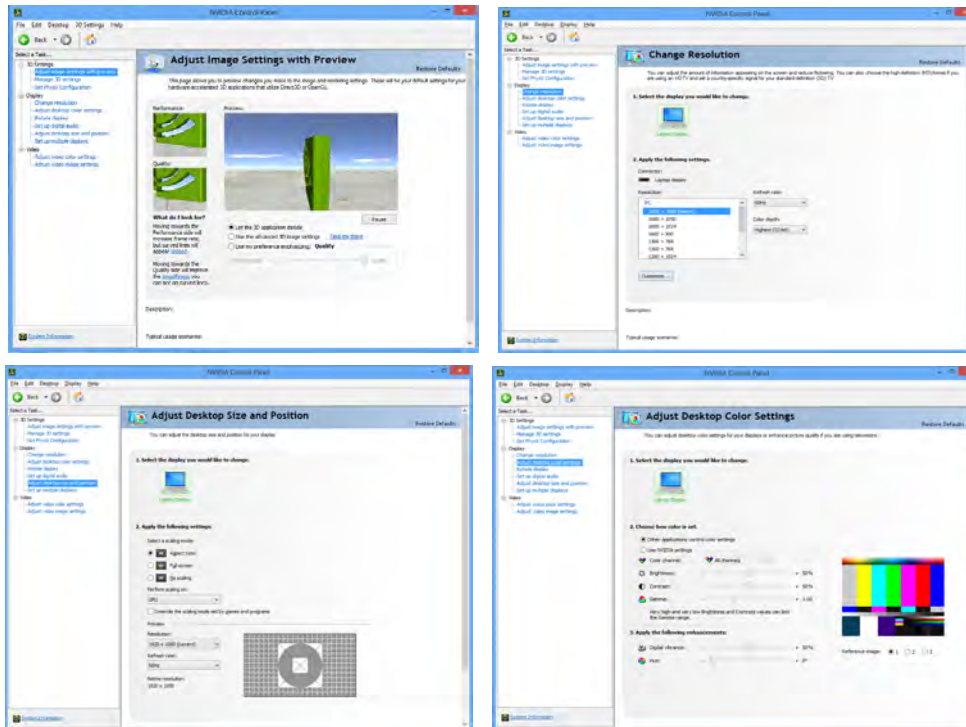

Figure C - 2
NVIDIA Control
Panels



NVIDIA Video Driver Controls

The **Help** menus provide index and search features, and direct links to the NVIDIA website etc.

Figure C - 3
Help Menu

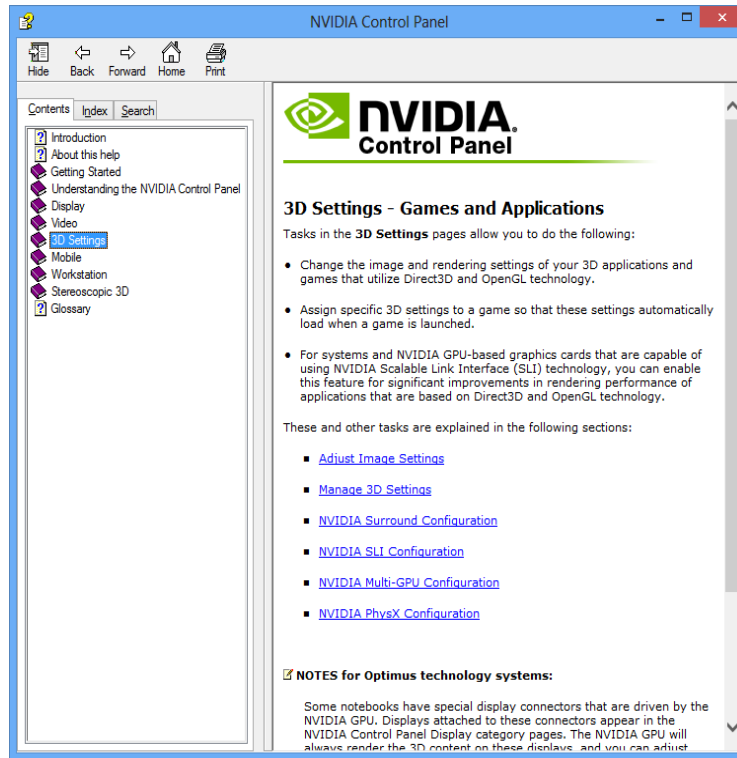

Display Devices

Note that you can use an HDMI (High-Definition Multimedia Interface) cable connected to the HDMI-Out port and/or Thunderbolt compatible cable connected to the Thunderbolt port to connect an external display. See your display device manual to see which formats are supported.

| Display Mode | Description |
|----------------|---|
| Single | One of the connected displays is used as the display device |
| Clone Displays | Clone simply shows an exact copy of the Primary display desktop on the other display(s). This mode will drive multiple displays with the same content |
| Extend | Extend treats both connected displays as separate devices, and they act as a virtual desktop resulting in a large workspace. When enabled, you can drag any icons or windows across to the other display desktop. It is therefore possible to have one program visible in one of the displays, and a different program visible in the other display |



Sound Blaster Audio & HDMI Connection

Note that Sound Blaster audio will be disabled when you are connecting to an external display through an HDMI connection.

Table C - 1
Display Modes



Display Not Shown

If the attached display does not appear in the “1.Select the displays you want to use.” window, click “**My Display is not shown...**” and then click the appropriate button to force detection of the missing display.

HDMI Audio Setup

See “**HDMI Audio Configuration**” on page C - 17 for instructions on configuring audio for HDMI display devices.

Configuring an External Display (NVIDIA)

Clone the Displays

1. Attach your external display to the appropriate port, and turn it on.
2. Go to **NVIDIA Control Panel** (see page C - 2).
3. Double-click **Display** (if the sub-menus are not visible), and then click **Set up multiple displays**.
4. Any attached display will appear under “1.Select the displays you want to use.”

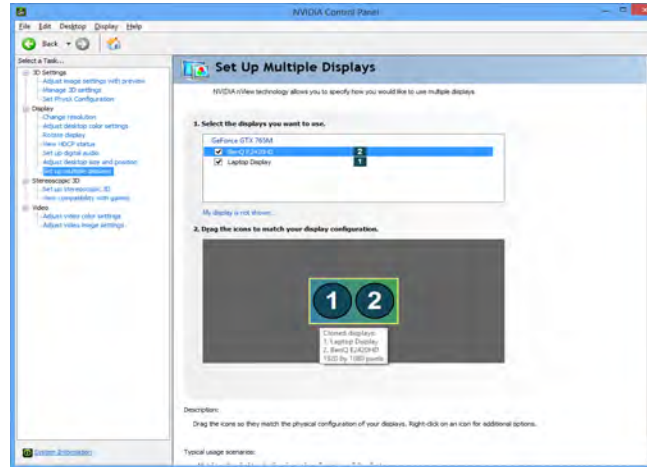
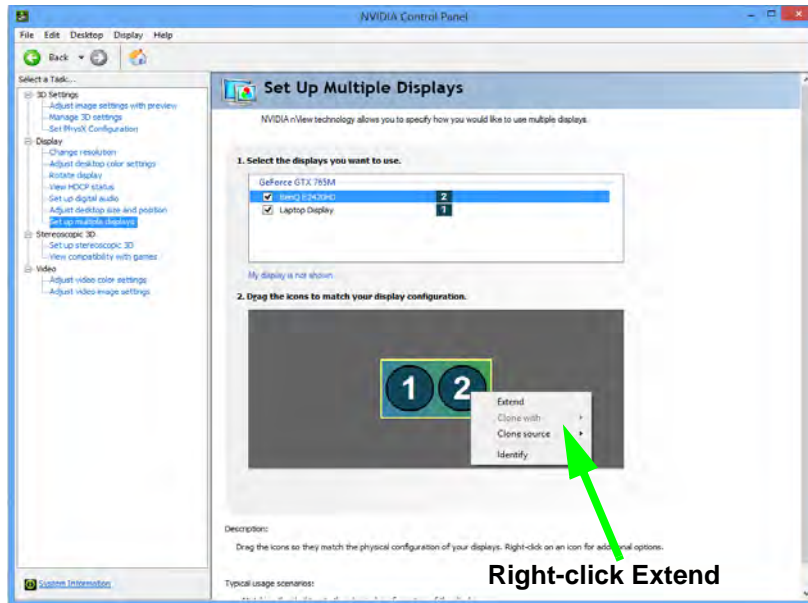

Figure C - 4
Set Up Multiple Displays

5. Click the tickbox alongside any display you wish to use.
6. Click **Apply > Yes** to save any changes made (the **Apply** button will appear in the bottom right of the control panel when changes have been made).

Extending the Display

1. Attach your external display to the appropriate port, and turn it on.
2. Go to **NVIDIA Control Panel** (see page C - 2).
3. Double-click **Display** (if the sub-menus are not visible), and then click **Set up multiple displays**.
4. Click to select a primary display under “**1. Select the displays you want to use.**”
5. Right-click the icons under “**2. Drag the icons to match**” and select **Extend**.



Changing the Primary Display on Extended Displays

If you want to switch the primary display if the displays are extended then right-click the secondary display icon and select “**Make Primary**”. **Click Apply > Yes** to save the change (see over).

Figure C - 5
Extend the Display

NVIDIA Video Driver Controls

6. The Primary display (the main window display) will be denoted by an **asterisk** * in the top right corner of the icon.
7. To change the Primary display **right-click the icon** and select **Make primary**.
8. Click **Apply > Yes** to save any changes.

Figure C - 6
Switch Primary Display

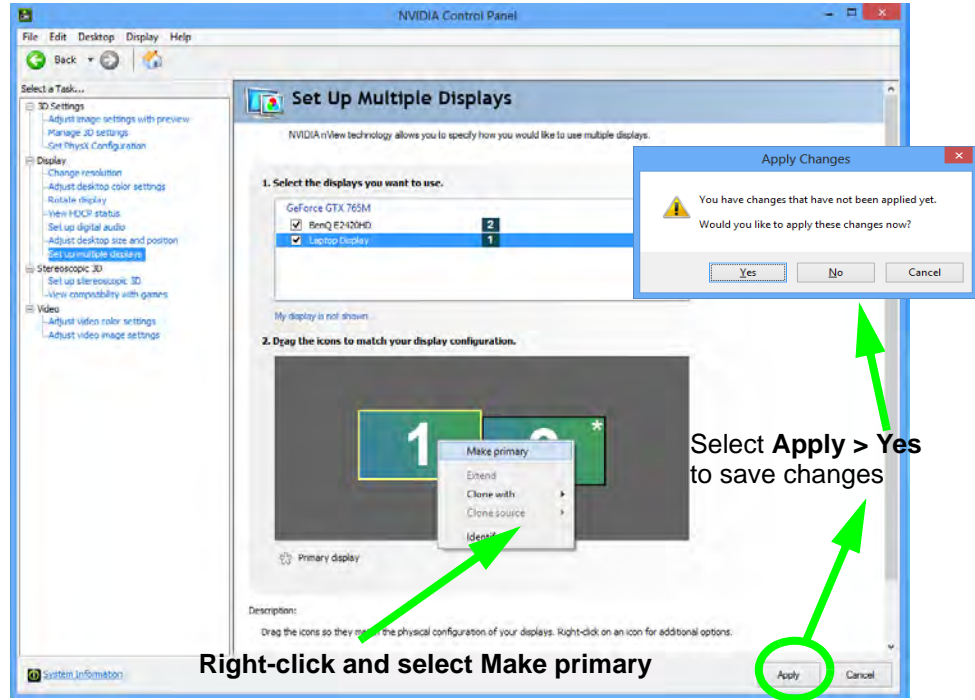

- You can drag the icons to match the desktop layout you want to use (e.g. you may want to extend the display to the right or left of the primary display).
- Click **Apply > Yes** to save any further changes.

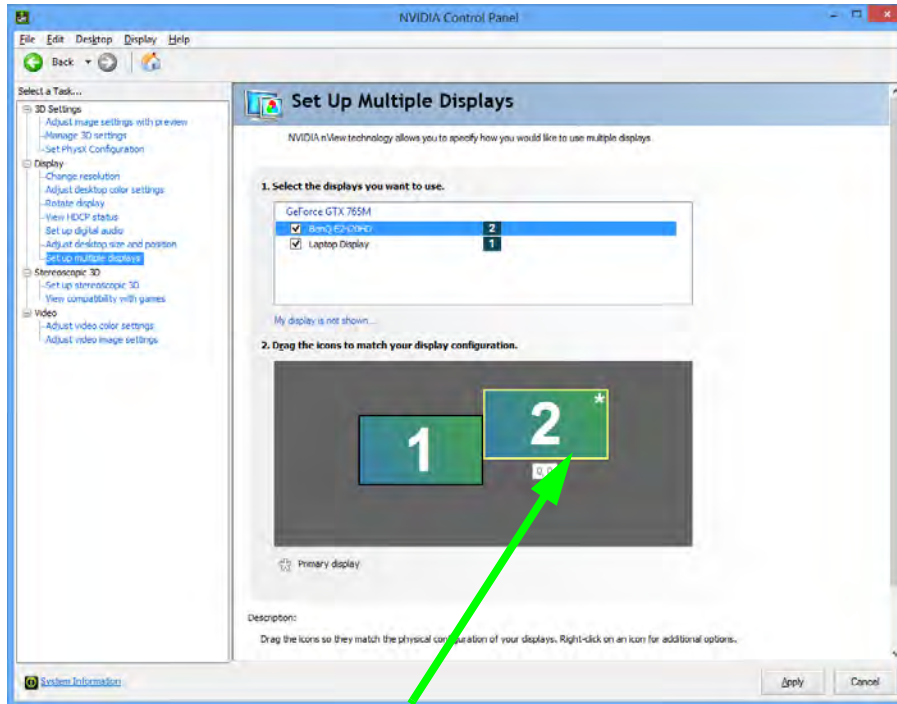

Figure C - 7
**Drag Display
Icons**

Drag the display icons to match the layout you want to use.

Multiple Display Connection to HDMI-Out Port & DisplayPort

Note that the **NVIDIA** video cards **can support up to two external displays** (one attached to the HDMI-Out port and another attached to the Thunderbolt port), in addition to the built-in LCD.

Therefore it is possible to set up 3 simultaneous displays (including the built-in LCD), and these may be configured in **Clone** mode or **Extend** mode as required. Connect all the attached displays to the appropriate ports, and configure them as outlined on the previous pages.

Attaching Other Displays - Devices (Charms Bar)

You can configure attached displays from **Devices** (in the *Windows 8 Charms Bar*).

1. Attach your external display to the HDMI-Out port (and/or Thunderbolt port), and turn it on.
2. Go the **Charms Bar** and select **Devices**.
3. Click **Second Screen**.
4. Click on any one of the options from the menu to select **Duplicate**, **Extend** or a Single (**PC Screen only** or **Second Screen only**) display.

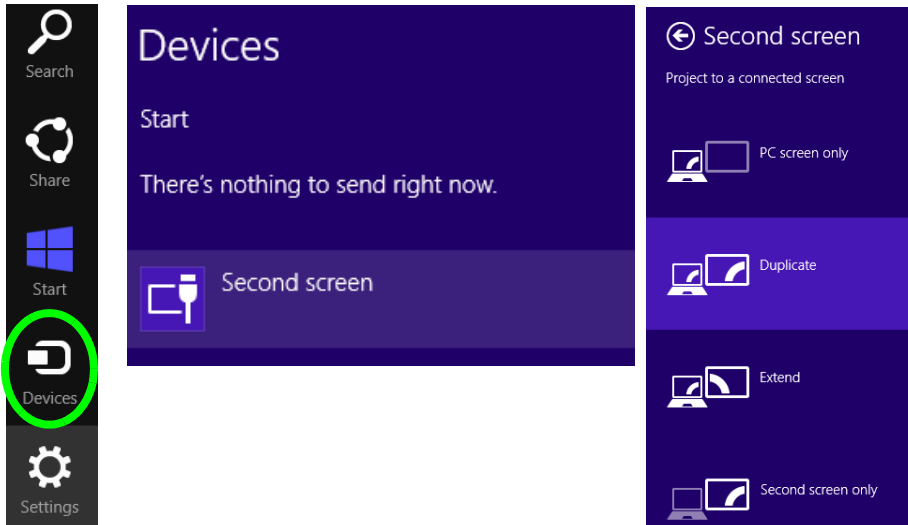

Windows Logo Key + P Key Combination

You can use the **Windows Logo Key + P** key combination to quickly bring up the **Second Screen** menu.

You can also use the **Display Switch** button in the **Control Center** to access the menu and select the appropriate attached display mode.

You can also use the **Fn + F7** key combination to quickly access the **Second Screen** menu in *Windows 8*.

Figure C - 8
Second Screen (Devices)

Configuring an External Display In Windows

1. Attach your external display to the HDMI-Out port (and/or Thunderbolt port), and turn it on.
2. Go to the **Screen resolution** control panel (see page 1 - 32) in the Desktop app.
3. Click the **Detect** button.
4. The computer will then detect any attached displays.

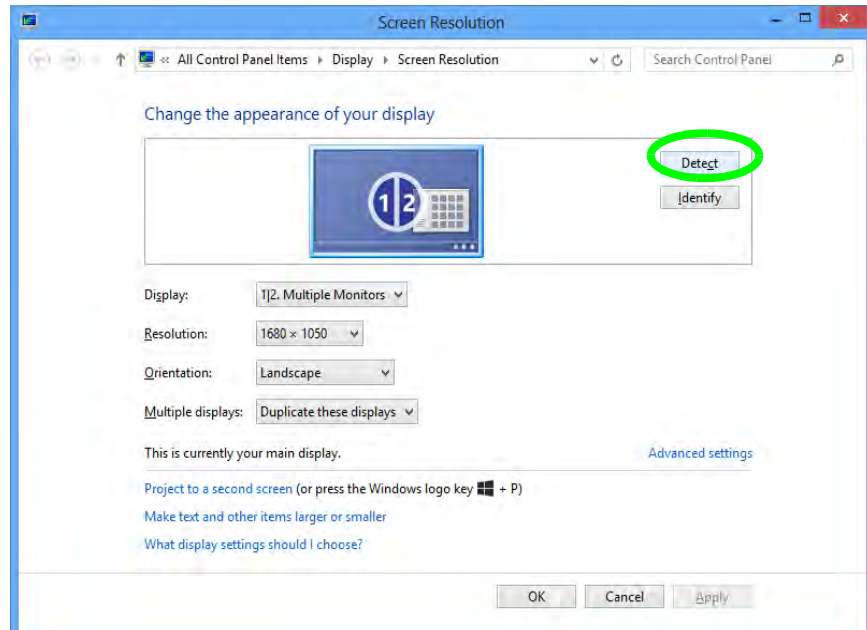

Figure C - 9
Screen Resolution
Multiple Displays

5. You can configure the displays from the **Multiple Displays** menu.

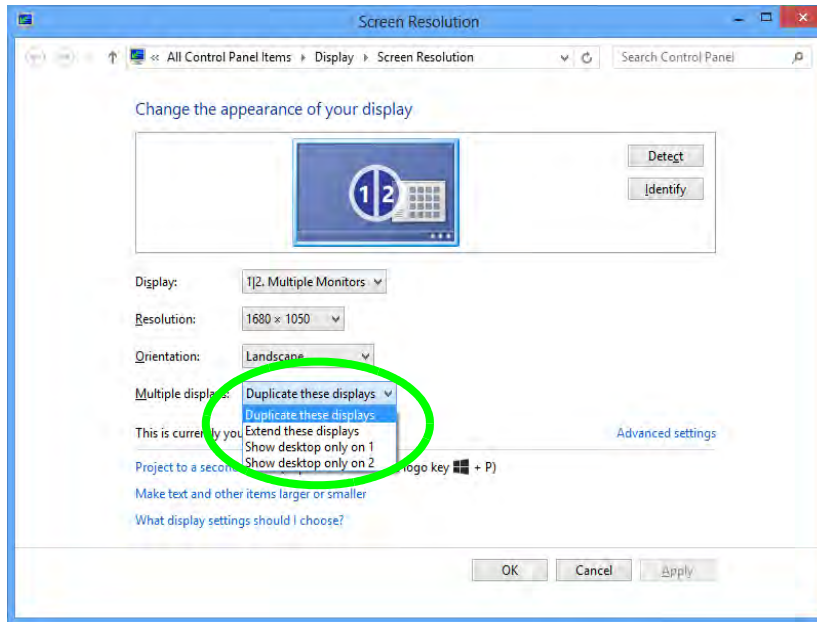

Figure C - 10
Screen Resolution
Multiple Display
Options

- Duplicate these displays - Shows an exact copy of the main display desktop on the other display(s)
- Extend these displays - Treats both connected displays as **separate** devices
- Show desktop only on 1/2 - Only one of your displays is used.

Video Card Options

Note that card types, specifications and drivers are subject to continual updates and changes. Check with your distributor/supplier for the latest details on video cards supported. Note that not all video card options for this computer model series support SLI configuration (see “Video Adapter” on page E - 2).

Figure C - 11
Set SLI
Configuration

NVIDIA® SLI Multi GPU Configuration

This computer features an NVIDIA Scalable Link Interface (SLI) that improves graphic quality and performance by combining dual NVIDIA GPUs (two video cards are required) in a single system. To enable/disable SLI Configuration:

1. Go to **NVIDIA Control Panel** (see page C - 2).
2. Click “+” next to **3D Settings** if its sub-items are not shown and then click **Set SLI and PhysX configuration**.

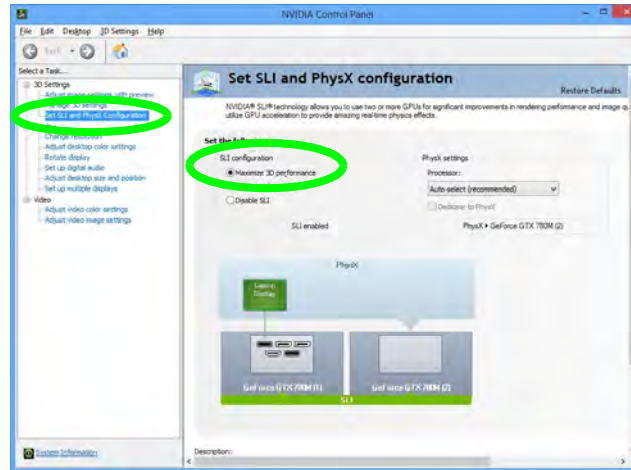

3. Click “Maximize 3D Performance” under “SLI configuration:”.
4. Click to select “PhysX settings; Auto-select (recommended) is the default setting.
5. Click **Apply** and **Restart Now** to restart the computer (see over).

Manage 3D Settings

You can configure the 3D **global settings** (to be applied to all application programs) or make specific adjustments for installed **program settings**.

1. Go to **NVIDIA Control Panel** (see page **C - 2**).
2. Click **Manage 3D Settings** and select either **Global Settings** or **Program Settings**.
3. Click the **Setting** menu items to select any global options required, or **select a program to customize** from the drop-down menu (click **Add** to add any program that does not appear in the menu).
4. Click **Apply** to save the settings.

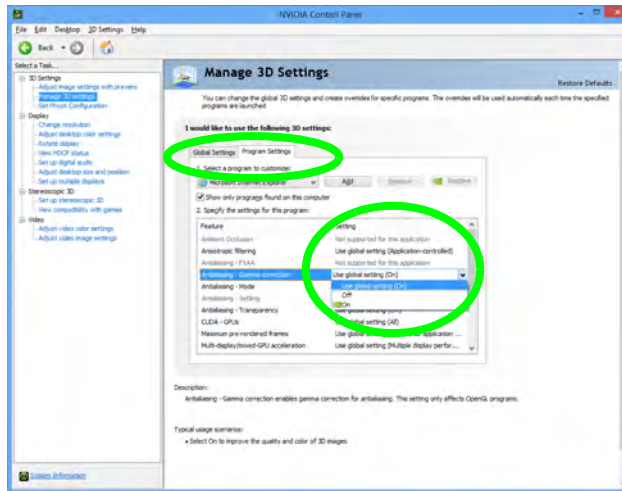

Figure C - 12
Manage 3D
Settings

Adjust Video Settings

You can adjust video color and image settings from the **Video** sub-menus.

1. Go to **NVIDIA Control Panel** (see page **C - 2**).
2. Click “+” next to **Video** if its sub-items are not shown and then click either **Adjust video color settings** or **Adjust video image settings**.
3. Make any adjustments required for any display and click **Apply** to save the settings.

Figure C - 13
Adjust Video Color Settings

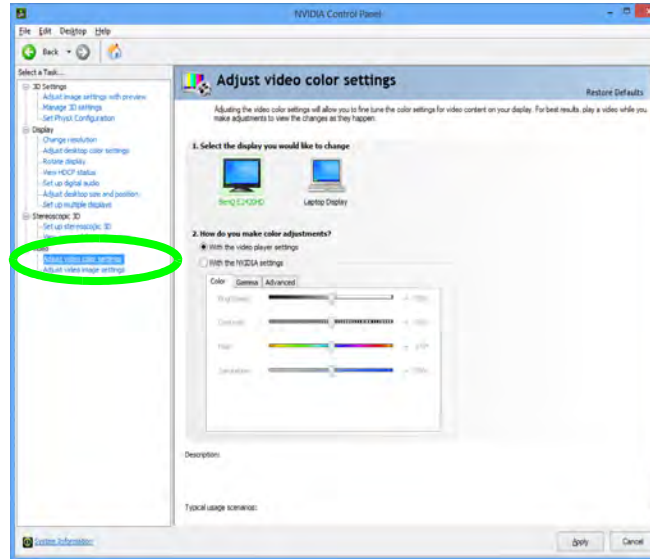

HDMI Audio Configuration

As HDMI (High-Definition Multimedia Interface) carries both **audio** and video signals you can configure the audio output from the **NVIDIA control panel** and **Sound** control panel. The settings will depend upon the external HDMI display you have connected to.

When you connect a display to the HDMI-Out port then the **Set up digital audio** item will appear under **Display**. Click **“Open Windows Sound Settings”** (button) to access the **Sound** control panel.

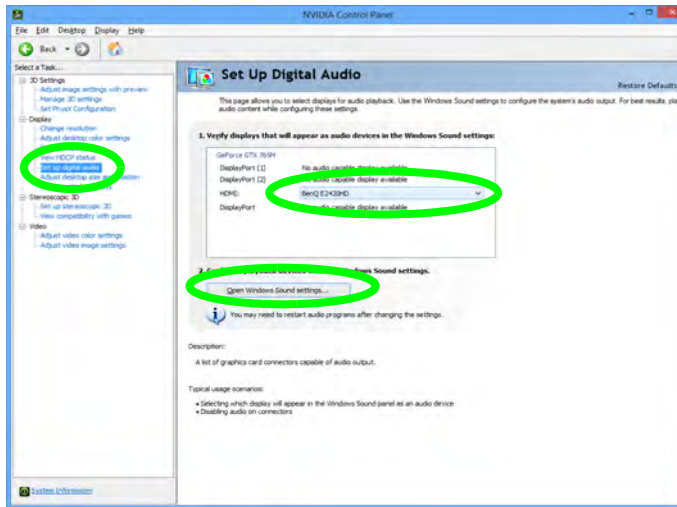

Figure C - 14
Set up Digital Audio

NVIDIA Video Driver Controls



Volume Adjustment

The sound volume level can be set using the volume control in the **Settings** menu in the **Charms Bar**.

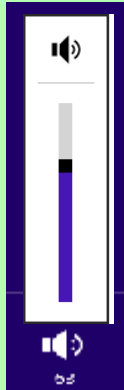

Audio Setup for HDMI

In some cases it will be necessary to go to the Sound control panel and manually configure the HDMI audio output.

1. Go to the **Sound** control panel.
2. Click **Playback** (tab)
3. The playback device will be selected.
4. You may need to select the audio device and click **Set Default** (button).
5. Double-click the device to access the control panel tabs.

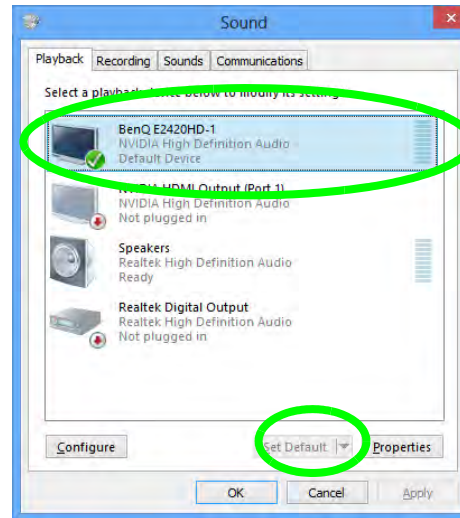

Figure C - 15

Sound - HDMI
Device (set Default)

- Adjust the HDMI settings from the control panel tabs.
- Click **OK** to close the **Sound** control panel.

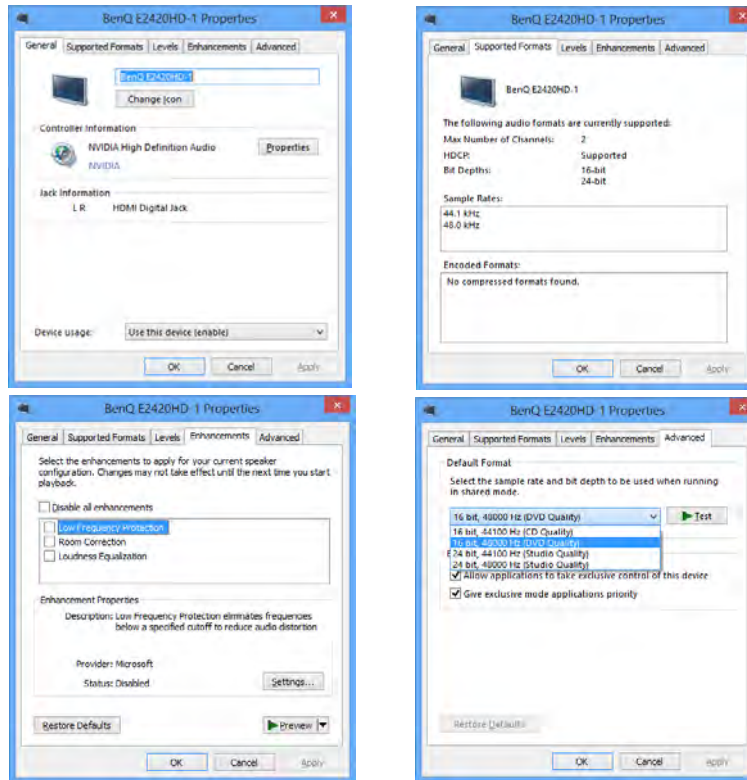

Figure C - 16
HDMI Device
Properties



Other Applications

If you are using a third party application to play DVDs etc. you will need to consult the application's documentation to see the appropriate audio configuration (the application must support digital to analog translation).

HDMI Notes

- Connect a device with HDMI support to the HDMI-Out port **BEFORE** attempting to play audio/video sources through the device.
- Under certain conditions, if the HDMI cable is disconnected, the default audio playback device will not revert to speakers until the computer is restarted (if you do not wish to restart the computer then go to the **Sound** control panel and select **Speakers** as the default audio playback device).

HDMI Video Configuration

1. Connect an HDMI cable from the HDMI-Out port to your external display.
2. Configure your external display as per the instructions in ***“Configuring an External Display (NVIDIA)” on page C - 6.***
3. Set up your external display (TV or LCD) for HDMI input (see your display device manual).
4. You can now play video/audio sources through your external display.

Sound Blaster Audio & HDMI

1. When you connect an HDMI display to the HDMI-Out port, the Sound Blaster audio controls will be disabled.
2. A warning box will pop-up and will prompt “..... **Do you want to select another audio device now?**”.
3. Click **No** to continue using the HDMI audio output from your external display (do not attempt to select another audio device when connected to the external HDMI display).

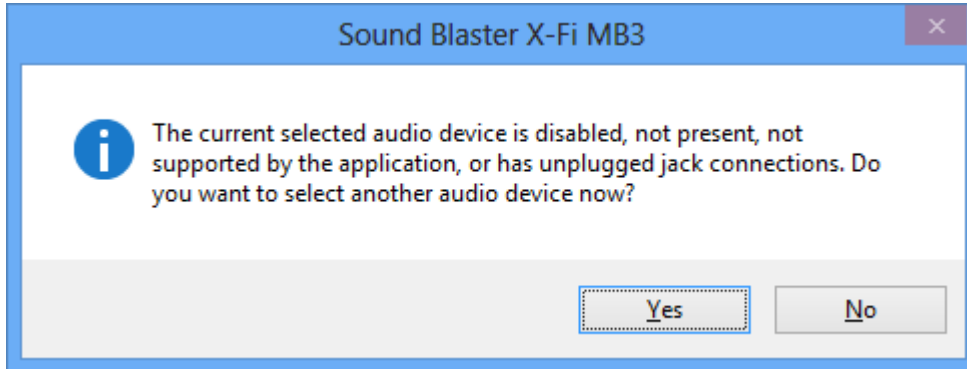

Figure C - 17
**Sound Blaster X-Fi
MB3 Audio Warning**

HDCP Status

If your external display is HDCP (High Bandwith Digital Content protection) compatible then the NVIDIA control panel will display the HDCP system status.

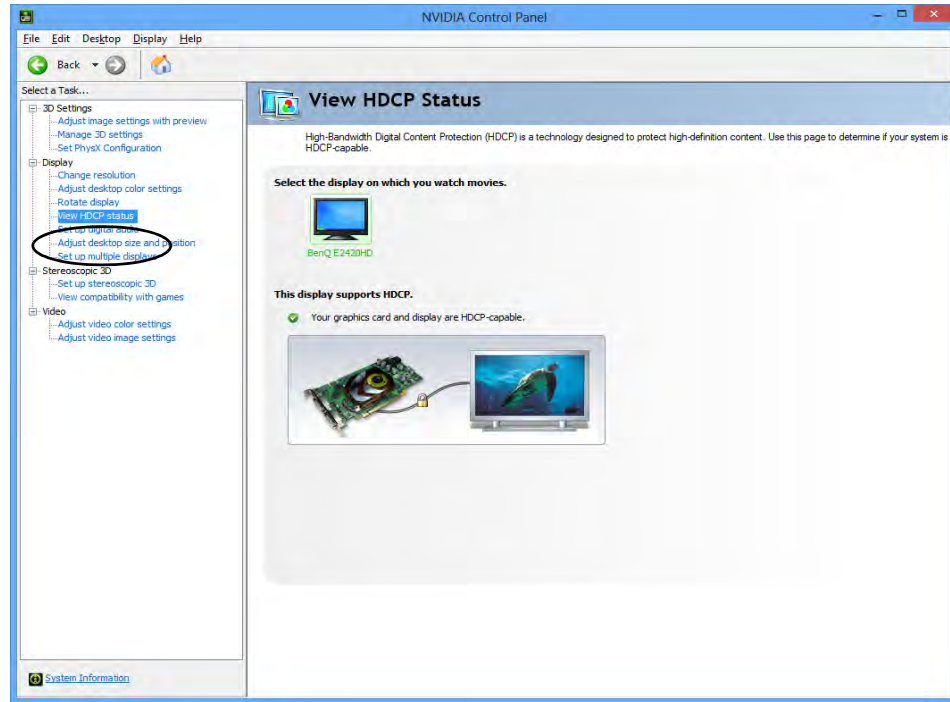

Figure C - 18
HDCP Status

NVIDIA 3D Shutter Glasses Kit

(for Model C Computers Only)

The NVIDIA 3DVISION shutter glasses kit is supported only by **Model B** computers with a 17.3"(43.94cm) FHD 120Hz panel and GTX 680M video card. Install the video driver as indicated in *“Video (VGA) - NVIDIA” on page 4 - 6.*



Important Safety Instructions

Make sure you read all the enclosed safety instructions and precautions included in the NVIDIA 3D Vision Kit before setting up the 3D Glasses and IR Emitter. Follow the setup instructions provided in the documentation to set up the 3D Vision kit safely and take the **“User Vision Test,”** which will initiate when you turn on your GeForce 3D Vision for the first time. If you cannot see the image in 3D during the test, you should DISCONTINUE USE IMMEDIATELY. Continued use may result in health-related complications.

The NVIDIA 3DVISION shutter glasses kit is supplied with a single pair of shutter glasses and all necessary cables etc. Set up the hardware (run the set up wizard as indicated overleaf) as instructed in the manual supplied with the kit, however **make sure you have installed the NVIDIA driver** (see *“Video (VGA) - NVIDIA” on page 4 - 6*) **from the Device Drivers & Utilities + User’s Manual disc.** For further details contact your distributor/supplier.

After the NVIDIA driver has been installed you can setup NVIDIA 3D Vision.



NVIDIA Driver

Install the NVIDIA driver (see *“Video (VGA) - NVIDIA” on page 4 - 6*) from the **Device Drivers & Utilities + User’s Manual disc** (to ensure compatibility).

Stereoscopic 3D Hardware Setup

This computer (**Model C Computers Only**) features a **built-in 3D IR emitter**. The effective viewing angles of the emitter are illustrated overleaf. Make sure that you are viewing the notebook screen within the area highlighted overleaf in order to get the proper stereoscopic 3D effect.

Figure C - 19
IR Emitter Location

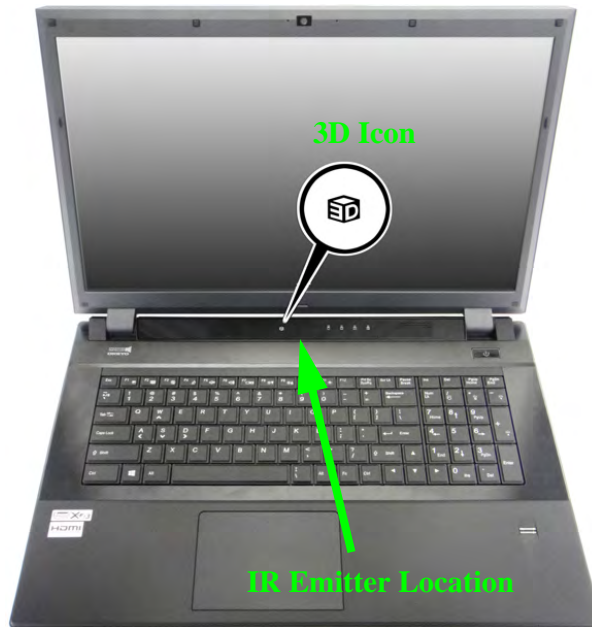

USB Connection & 3D Glasses

The light on the glasses will **flash amber while charging**, and **solid amber when fully charged**.

The glasses hold approximately 40 hours of viewing per full charge. **Flashing red** indicates that less than 2 hours of charge are remaining.

The indicator light displays for about 30 seconds after turning the glasses on

Viewing Angles

The emitter's **horizontal** viewing angle is **100 degrees**.

The emitter's **vertical** viewing angle is **75 degrees**.

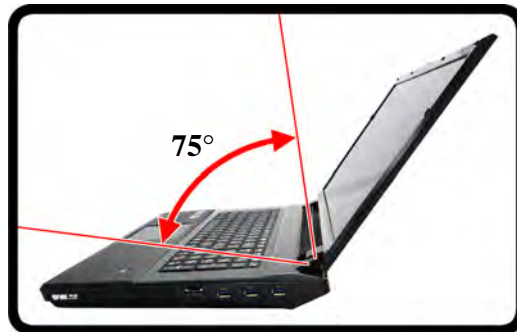
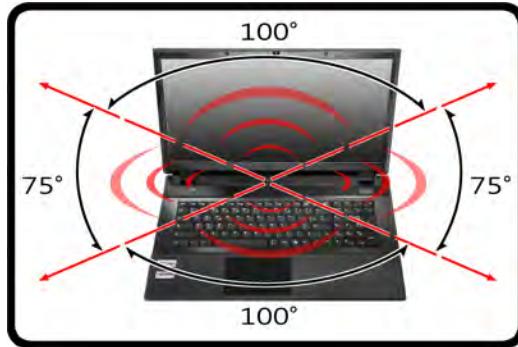

Figure C - 20
Emitter - Viewing
Angles

NVIDIA Control Panel

To access the **GeForce.....** control panel from the desktop; right-click the **desktop**, then click **NVIDIA Control Panel**.

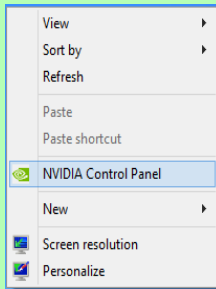
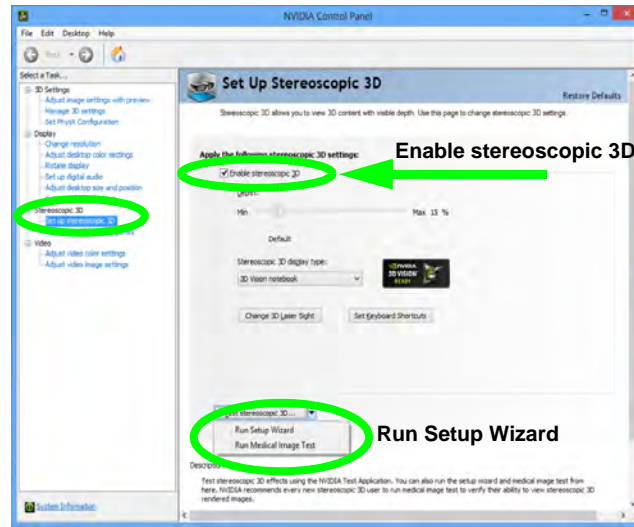

Figure C - 21

Set Up Stereoscopic 3D

Set Up Stereoscopic 3D

1. Make sure your 3D glasses are powered on, connected to the USB cable provided and that the cable is plugged-in to one of the computer's USB ports (check the documentation provided with the glasses kit for latest information on the glasses setup).
2. Go to the NVIDIA control panel.
3. Double-click **Stereoscopic 3D** (if the sub-menus are not visible), click **Set up stereoscopic 3D** and then click **Run Setup Wizard**.
4. Follow the on-screen instructions to set up 3D Vision and click "Next" to progress through the steps (this notebook has a built-in emitter).



5. During the setup procedure you will need to click to answer questions on what you see in 3D on the screen.
6. Configure the stereoscopic 3D from the control panels (make sure you charge the 3D shutter glasses by plugging them into one of the computer's USB ports using the USB cable provided).
7. You can select **Run Setup Wizard** or **Run Medical Image Test** from **Test Stereoscopic 3D** menu at the bottom of the control panel.
8. The stereoscopic depth may be adjusted by using the control panel slider.
9. Click **View Compatibility with Games** to check 3D support for any games.

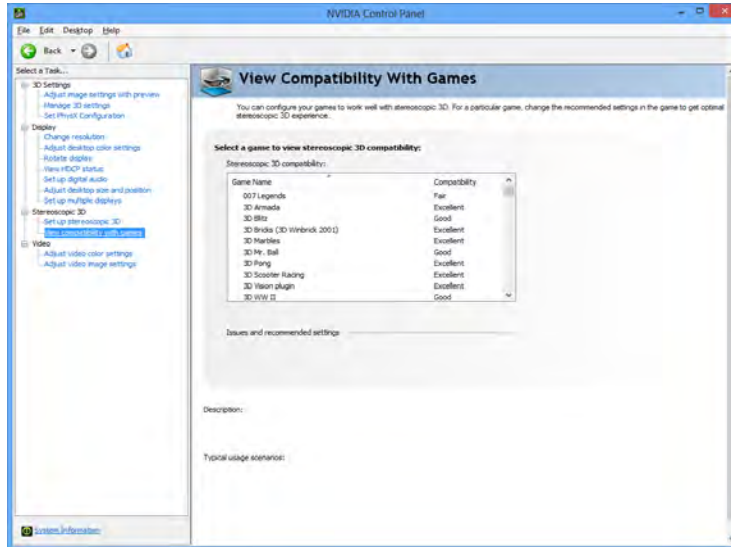

Figure C - 22
**View Compatibility
With Games**

Appendix D: AMD Video Driver Controls

The basic settings for configuring the LCD are outlined in *“Video Features” on page 1 - 39*.

AMD Video Driver Installation

Make sure you install the drivers in the order indicated in *Table 4 - 1, on page 4 - 3*.

1. Click **2.Install VGA Driver > Yes**.
2. Click **Next > Install** (button).
3. Click the **Express** (or **Custom** if you prefer to manually configure the driver installation settings) button and click **Next**.
4. Click **Accept** (button).
5. Click **Finish > Yes** to restart the computer.



Video Card Options

Note that card types, specifications and drivers are subject to continual updates and changes. Check with your distributor/supplier for the latest details on video cards supported (see *“Video Adapter” on page E - 2*).



Taskbar Icon

The **Catalyst™ Control Center** can also be accessed by double-clicking the icon  in the notification area of the taskbar (or by right-clicking the icon and selecting **Catalyst Control Center**).

If you don't see the icon in the taskbar, click **Preferences** in the **Catalyst™ Control Center**, and select **Enable System Tray Menu**.

Figure D - 1
Catalyst Control Center Access

AMD Catalyst™ Control Center

Adjust the video settings from the **Catalyst™ Control Center**.

1. Right-click the desktop and select  **Catalyst Control Center**.
OR
2. Click **Advanced settings** in the **Screen Resolution** control panel (see [“Video Features” on page 1 - 39](#)), click the **Catalyst Control Center** tab and then click **Catalyst Control Center**.

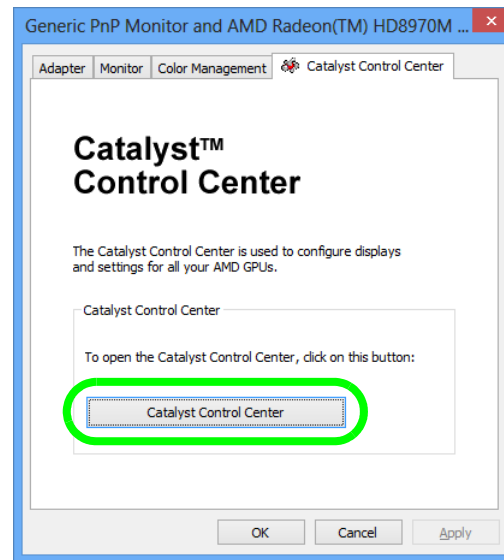
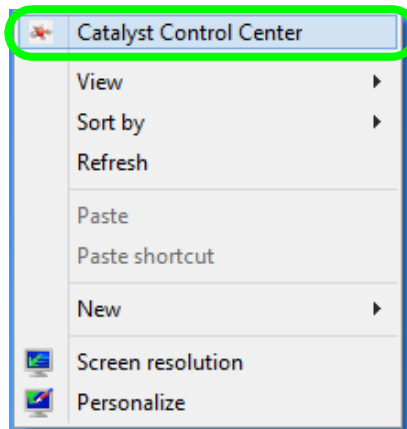

Catalyst™ Control Center Preferences

The **Preferences** button in the **Catalyst™ Control Center** menu allows you to configure the control panel settings. You can view the control panel in either **Standard View** or **Advanced View**. To display **Standard View** or **Advanced View**:

1. Open the **Catalyst™ Control Center**.
2. Click the **Preferences** button and select either **Advanced View** or **Standard View**.

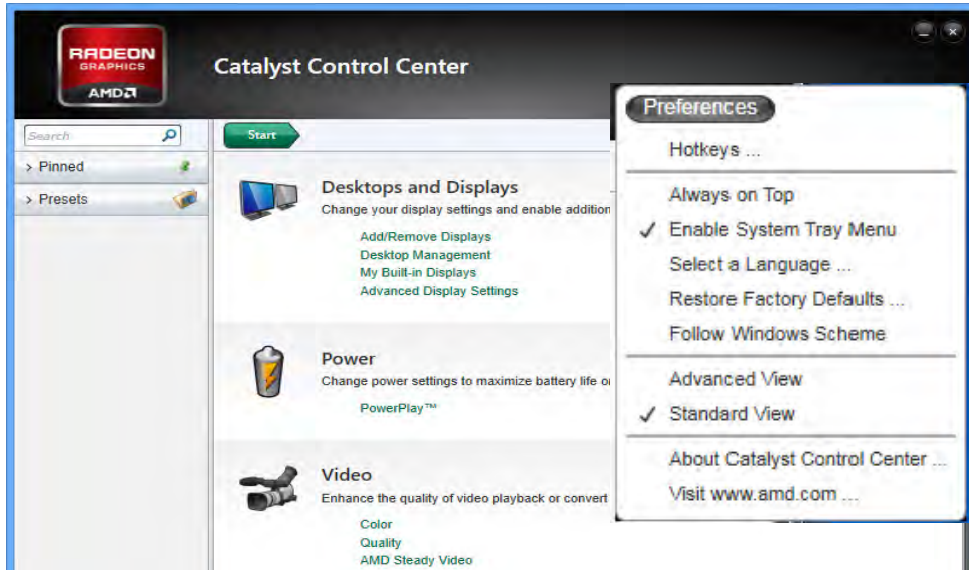

Preferences & Views

You can switch between **Advanced** and **Standard** views from the **Preferences** menu.

Help Menus

Press **F1** to bring up **Help** menu. Click the question mark icon **?** in the top right to bring up help on a specific page.

Figure D - 2
Catalyst Control Center Preferences

AMD Video Driver Controls

Standard View

The **Standard View** menus feature a series of menu headings with clickable sub-menus which allow you to adjust **Desktops and Displays**, **Power**, **Video**, **Gaming** and **Information**. Click the **Start** button to access the top level menu from any sub-menu heading.

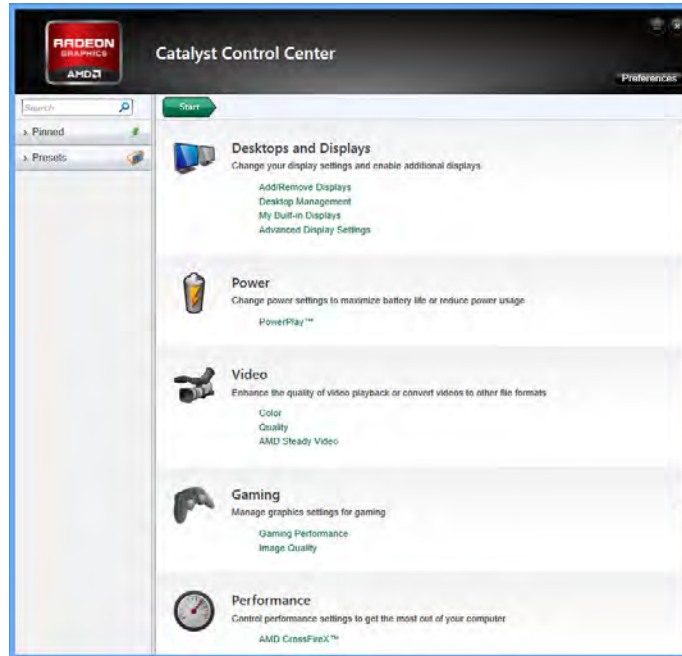

Figure D - 3
Catalyst Control
Center Standard View

D

Advanced View

The **Advanced View** menus display all the menu headings as a series of buttons on the left. Click the arrows in any button to display the sub-menus (note all the figures in the remainder of this chapter are in **Advanced View**).



Sub-Menus

Click a menu button to expand any sub-menus, and then click the appropriate sub-menu heading to configure the item.

Catalyst Control Center Versions

Due to driver updates your Control Center screens may appear slightly different from those pictured on these pages.

Figure D - 4
Catalyst Control Center Advanced View

AMD Video Driver Controls



Help Menus

Press **F1** to bring up **Help** menu. Click the question mark **?** in the top right to bring up help on a specific page.

Figure D - 5
ATI Catalyst Control
Center Advanced
Menus

The **Catalyst™ Control Center** provides additional video configuration controls and tools which allow quick access to features such as display options, 3D Settings, color, power and Information menus etc. Adjust settings from the options in the sub-menus.

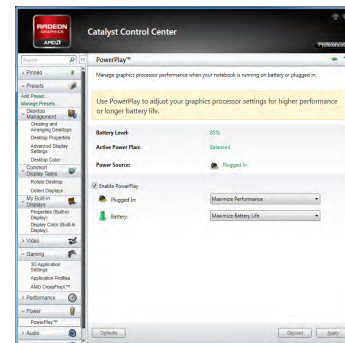

Display Devices & Options

Note that you can use the HDMI (High-Definition Multimedia Interface) cable connected to the HDMI-Out port or DisplayPort cable connected to the DisplayPort to connect an external display. See your display device manual to see which formats are supported.

| Display Mode | Description |
|--------------|---|
| Single | One of the connected displays is used as the display device |
| Duplicate | Both connected displays output the same view |
| Extend | Both connected displays are treated as separate devices, act as a virtual desktop and may be configured independently |



Sound Blaster Audio & HDMI Connection

Note that **Sound Blaster audio will be disabled** when you are connecting to an external display through an **HDMI connection**.

Table D - 1
Display Modes



Detect Displays

Click **Detect Displays** (button) to automatically update the attached display information.

You can set a preference for automatic display detection in **Advanced Display Settings (Desktop Management)**. You can choose to have attached displays automatically detected when the CCC is opened, or to use manual detection only.

Configuring an External Display In the CCC

You can use the **Catalyst™ Control Center** to configure any attached displays.

1. Attach your external display to the appropriate port, and turn it on.
2. Open the **Catalyst™ Control Center**.
3. Select **Desktop Management** from the menu on the left (click the arrow to expand the menu) and click **Creating and Arranging Desktops**.
4. Attached displays will appear in the lower part of the screen (click **Detect Displays** to find any attached displays that do not automatically appear).

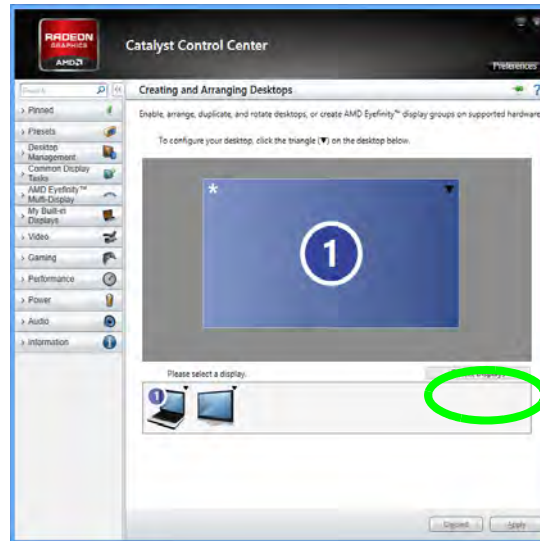

Click **Detect Displays** to find any attached displays that do not automatically appear.

Figure D - 6
Desktop Management

5. Click the triangle icon ▼ (or right-click the display icon) on the attached display icon at the bottom to bring up the options (e.g **Duplicate** or **Extend**).
6. Select an option from the menu (click **Continue** if required), and click **Yes** to accept the settings.

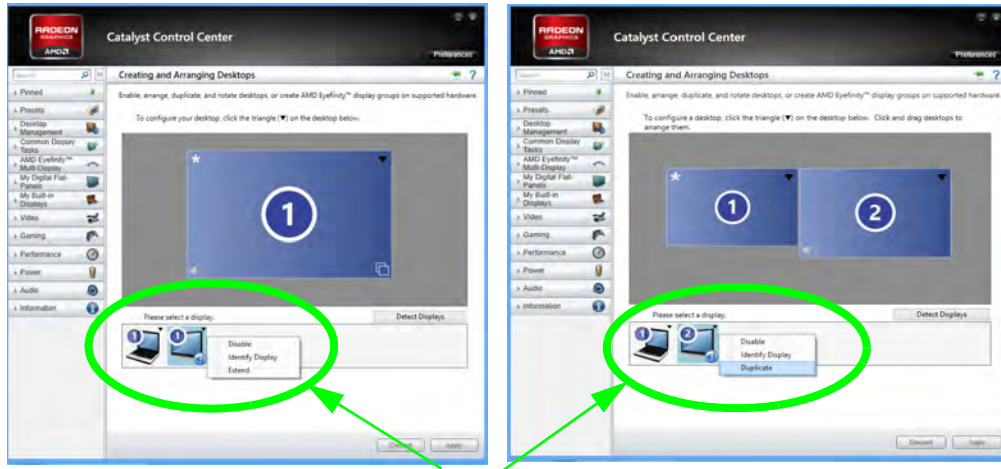

Attached displays will appear here.

Disable Displays

If you want to disable any of the displays, right-click the display icon at the bottom of the screen and click **Disable**.

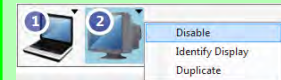
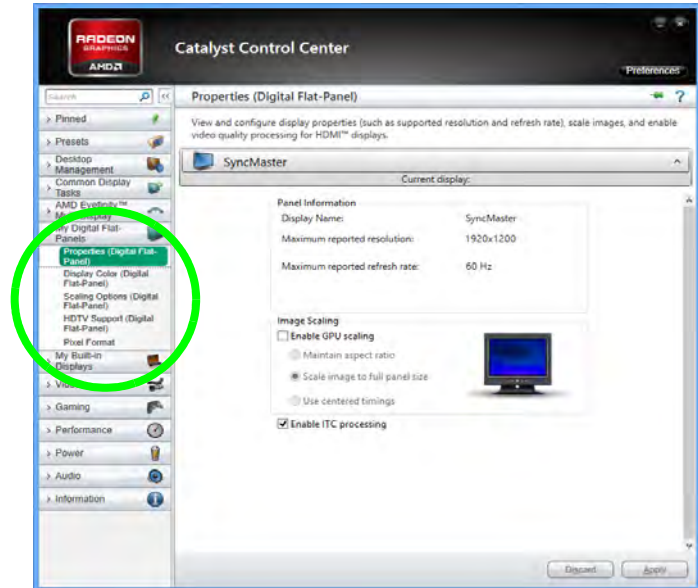
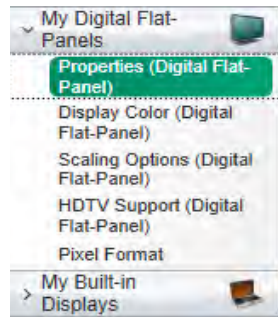

Figure D - 7
Desktop Management with External Display

My Digital Flat-Panels

An additional menu button entitled My Digital Flat-Panels will appear when an external digital display is attached. This menu allows you to configure the properties of the external display. After making any adjustments you may need to click the **Apply** button to confirm the changes.

Figure D - 8
**My VGA Displays/
My Digital Flat-
Panels**



HDTV Support

If your flat panel supports HDTV functions then this can be configured from **My Digital Flat-Panels > HDTV Support (Digital Flat-Panel)**.

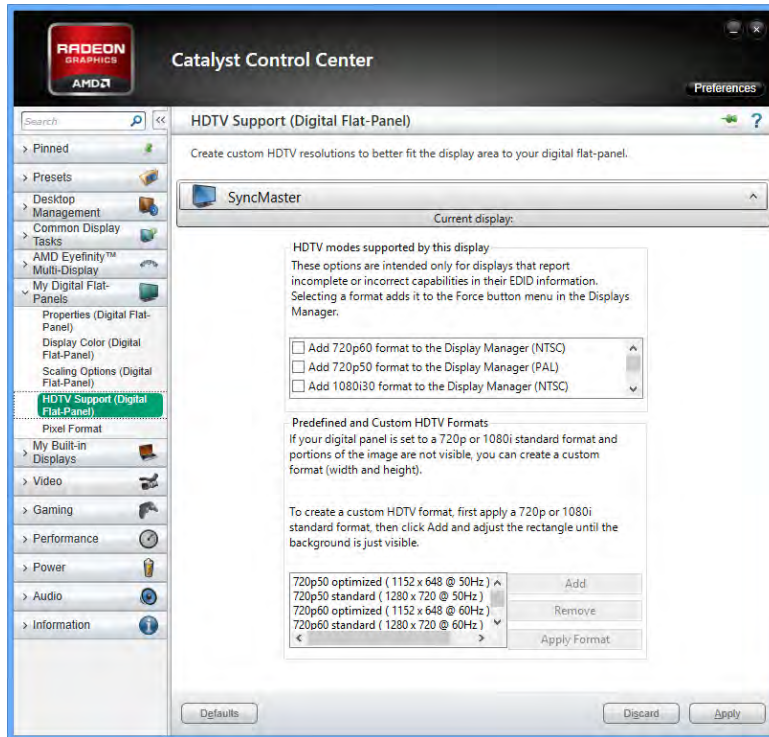

Figure D - 9
My Digital Flat-Panels
(HDTV Support)



Windows Logo Key + P Key Combination

You can use the **Windows Logo Key + P** key combination to quickly bring up the **Second Screen** menu.

You can also use the **Display Switch** button in the **Control Center** to access the menu and select the appropriate attached display mode.

You can also use the **Fn + F7** key combination to quickly access the **Second Screen** menu in **Windows 8**.

Attaching Other Displays - Devices (Charms Bar)

You can configure attached displays from **Devices** (in the **Windows 8 Charms Bar**).

1. Attach your external display to the HDMI-Out port (and/or Thunderbolt port), and turn it on.
2. Go the **Charms Bar** and select **Devices**.
3. Click **Second Screen**.
4. Click on any one of the options from the menu to select **Duplicate**, **Extend** or a **Single (PC Screen only or Second Screen only)** display.

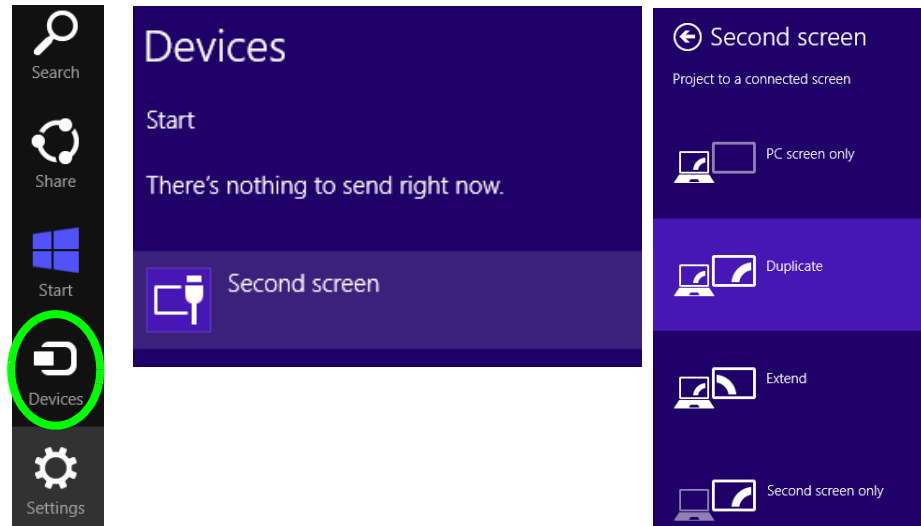

Figure D - 10
Second Screen
(Devices)

Configuring an External Display In Windows

1. Attach your external display to the HDMI-Out port (and/or Thunderbolt port), and turn it on.
2. Go to the **Screen resolution** control panel (see page 1 - 32) in the Desktop app.
3. Click the **Detect** button.
4. The computer will then detect any attached displays.

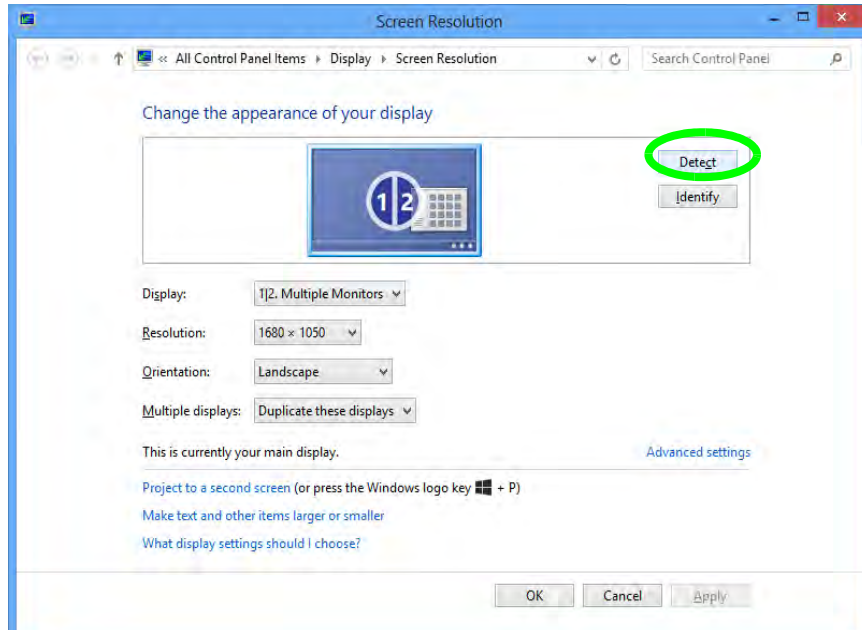

Figure D - 11
**Screen Resolution
Multiple Displays**

AMD Video Driver Controls

5. You can configure the displays from the **Multiple Displays** menu.

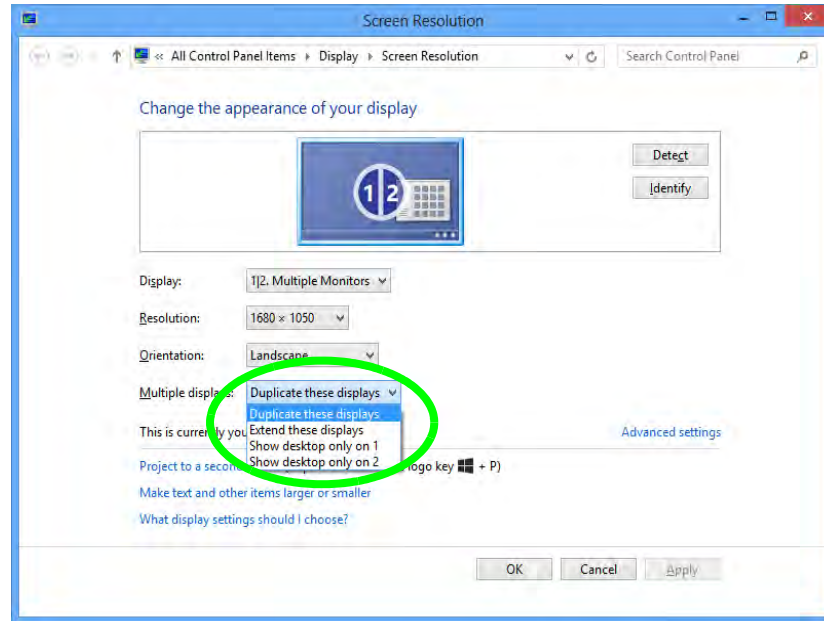

Figure D - 12
**Screen Resolution
Multiple Display
Options**

- Duplicate these displays - Shows an exact copy of the main display desktop on the other display(s)
- Extend these displays - Treats both connected displays as **separate** devices
- Show desktop only on 1/2 - Only one of your displays is used.

PowerPlay™

When enabled, **PowerPlay™** can be used to automatically set to adjust the graphics processor settings for higher performance or longer battery life when the system is either **Plugged In** or on **Battery**.

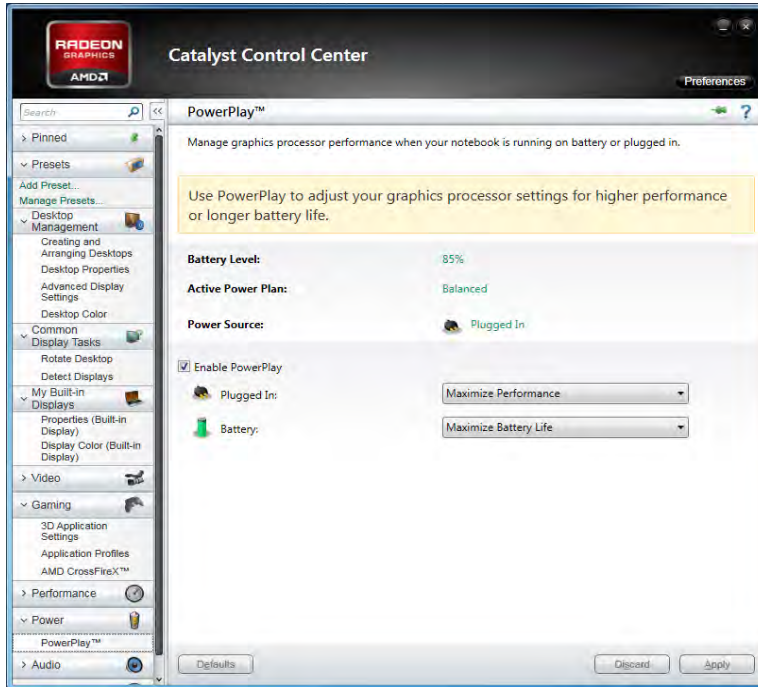

Figure D - 13
PowerPlay™

AMD CrossFireX™ Multi GPU Configuration

The **Gaming** menu includes configuration options for AMD CrossFireX™. AMD CrossFireX™ combines the processing power of multiple GPUs to a single display, and this may be enabled/disabled from the **AMD CrossFireX™ Configuration** menu (this sub-menu is also available in the Performance menu).

Figure D - 14
**Gaming - AMD
CrossFireX™**



HDMI Audio Configuration

HDMI (High-Definition Multimedia Interface) carries both **audio** and video signals. Configure the audio output as per the instructions below.

1. Go to the **Sound** control panel.
2. Click **Playback** (tab)
3. The playback device will be selected.
4. You may need to select the audio device and click **Set Default** (button).
5. Double-click the device to access the control panel tabs.

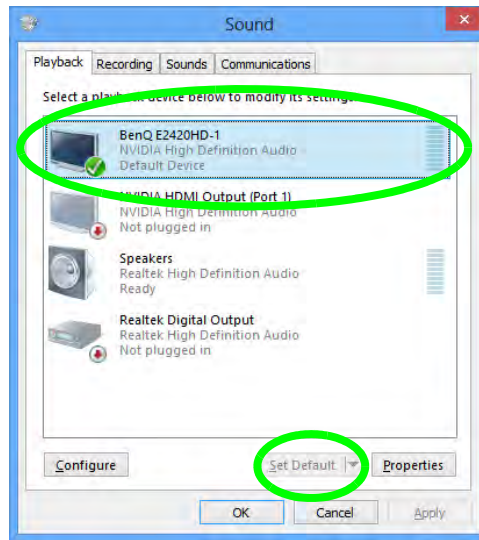

Volume Adjustment

The sound volume level can be set using the volume control in the **Settings** menu in the **Charms Bar**.

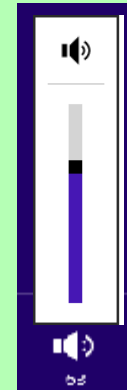

Figure D - 16

Sound - HDMI
Device (set Default)

AMD Video Driver Controls

- Adjust the HDMI settings from the control panel tabs.
- Click **OK** to close the **Sound** control panel.

Figure D - 17
HDMI Device
Properties

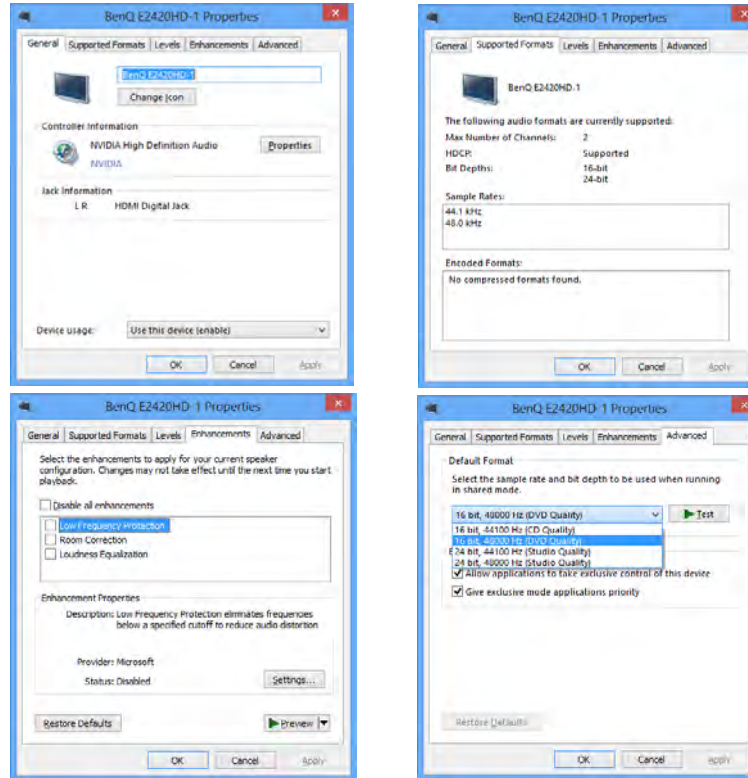

HDMI Notes

- Connect a device with HDMI support to the HDMI-Out port **BEFORE** attempting to play audio/video sources through the device.
- To play audio sources through your external display's (TV or LCD) speakers you will need to go to the audio configuration control panel on the display and configure the audio input accordingly (see your display device manual).

HDMI Video Configuration

1. Connect an HDMI cable from the HDMI-Out port to your external display.
2. Configure your external display as per the instructions in *"Configuring an External Display In the CCC" on page D - 8*.
3. Set up your external display (TV or LCD) for HDMI input (see your display device manual).
4. You can now play video/audio sources through your external display.



Other Applications

If you are using a third party application to play DVDs etc. from any attached DVD device, you will need to consult the application's documentation to see the appropriate audio configuration (the application must support digital to analog translation).

Sound Blaster Audio & HDMI

1. When you connect an HDMI display to the HDMI-Out port, the Sound Blaster audio controls will be disabled.
2. A warning box will pop-up and will prompt “..... **Do you want to select another audio device now?**”.
3. Click **No** to continue using the HDMI audio output from your external display (do not attempt to select another audio device when connected to the external HDMI display).

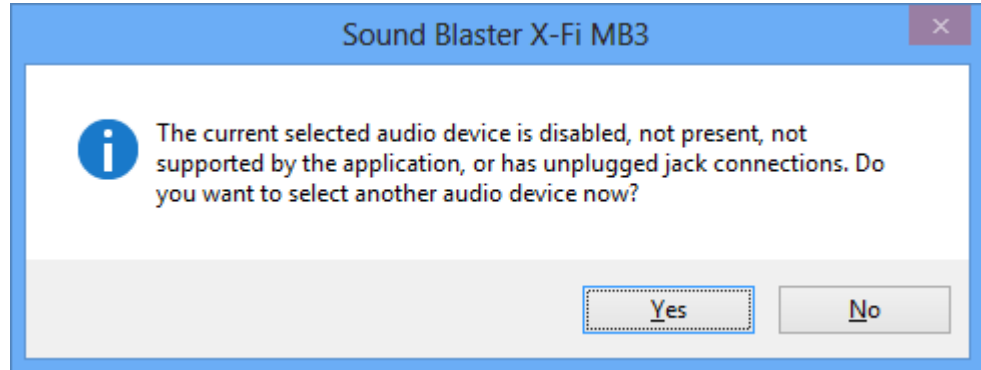

Figure D - 18
**Sound Blaster X-Fi
MB3 Audio Warning**

Audio

You can use Audio menu in the **Catalyst™ Control Center** to configure any attached audio device.



Figure D - 19
Audio

Appendix E: Specifications



Latest Specification Information

The specifications listed in this Appendix are correct at the time of going to press. Certain items (particularly processor types/speeds and CD/DVD device types) may be changed, updated or delayed due to the manufacturer's release schedule. Check with your distributor/supplier for details.

Specifications

| Processor | Display | Video Adapter |
|---|---|---|
| <p>Intel® Core™ i7-4930MX (3.00GHz) Extreme Edition Processor 8M L3 Cache, 22nm (22 Nanometer), DDR3L-1600MHz, TDP 57W</p> | <p><u>Models A & B:</u> 17.3" (43.94cm) FHD (1920 * 1080) 16:9 Backlit Panel</p> | <p><u>For All Models:</u> NVIDIA® GeForce GTX 780M PCIe * 8 Video Card (Dual VGA PCIe 8*2) 4GB GDDR5 Video RAM</p> |
| <p>Intel® Core™ i7-4900MQ (2.80GHz) Processor 8M L3 Cache, 22nm (22 Nanometer), DDR3L-1600MHz, TDP 47W</p> | <p><u>Model C:</u> 17.3" (43.94cm) FHD (1920 * 1080) 16:9, 120Hz, Backlit Panel Built-In 3D Emitter Supports NVIDIA® 3D Vision™ Kit with 2 * Shutter Glasses</p> | <p>Supports DirectX® 11.1 Supports DisplayPort 1.2 NVIDIA PhysX™ GeForce CUDA™ Technology Supports NVIDIA® SLI® Technology</p> |
| <p>Intel® Core™ i7-4800MQ (2.70GHz) Processor 6M L3 Cache, 22nm (22 Nanometer), DDR3L-1600MHz, TDP 47W</p> | <p>Memory</p> | <p><u>For Model C Only:</u> Supports 3D TV Play™</p> |
| <p>Intel® Core™ i7-4700MQ (2.40GHz) Processor 6M L3 Cache, 22nm (22 Nanometer), DDR3L-1600MHz, TDP 47W</p> | <p>Dual Channel DDR3L Four 204 Pin SO-DIMM Sockets Supporting DDR3L 1600 MHz Memory Modules (real operational frequency depends on the FSB of the processor) Memory Expandable up to 32GB Compatible with 2GB/4GB/8GB Modules</p> | <p><u>For Models A & B Only:</u> NVIDIA® GeForce GTX 765M PCIe * 8 Video Card (Dual VGA PCIe 8*2) 2GB GDDR5 Video RAM Supports DirectX® 11.1 Supports DisplayPort 1.2 NVIDIA PhysX™ GeForce CUDA™ Technology Supports NVIDIA® SLI® Technology</p> |
| <p>Core Logic</p> | | |
| <p>Mobile Intel® HM87 Express Chipset</p> | | <p>See over</p> |

| | | |
|---|---|--|
| <p>For Models A & B Only: NVIDIA® GeForce GTX 770M PCIe * 8 Video Card (Dual VGA PCIe 8*2) 3GB GDDR5 Video RAM Supports DirectX® 11.1 Supports DisplayPort 1.2 NVIDIA PhysX™ GeForce CUDA™ Technology Supports NVIDIA® SLI® Technology</p> <p>AMD Radeon™ HD 8970M PCIe * 8 Video Card (Dual VGA PCIe 8*2) 4GB GDDR5 Video RAM Supports DirectX® 11.1 Supports DisplayPort 1.2 Supports AMD Eyefinity™ Technology Supports AMD CrossfireX™ Technology</p> <p>NVIDIA® Quadro K5000M PCIe * 8 Video Card 4GB GDDR5 Video RAM Supports DirectX® 11 Supports DisplayPort 1.2 NVIDIA PhysX™ GeForce CUDA™ Technology OpenGL 4.3</p> | <p>Storage</p> <p>Up to two (Factory Option) Changeable 2.5" 9.5 mm (h) SATA (Serial) Hard Disk Drives/Solid State Drives supporting RAID level 0/1/Recovery</p> <p>One 12.7 mm Super Multi/Blu-Ray Combo/Blu-Ray Writer SATA Optical Device Drive (Factory Option)</p> <p>Two mSATA Solid State Drives (SSD) with SATA (RAID 0/1) Interface (Factory Option)</p> <p>Audio</p> <p>High Definition Audio S/PDIF Digital Output 2 Built-In 2W Speakers One built-in Subwoofer Speaker Sound Blaster® X-Fi™ MB3 External 7.1CH Audio output supported by headphone, microphone, S/PDIF & Line-In Jack Built-In Microphone (for Models A & C) OR Built-In Array Microphone (for Model B)</p> | <p>Keyboard & Pointing Device</p> <p>Full Size Winkey Illuminated Keyboard with Numeric Keypad</p> <p>Built-In Clickpad (with Multi Gesture Functionality & Scrolling Function - for Model A & C)</p> <p>Built-In Illuminated Touchpad (with Multi Gesture Functionality & Scrolling Function) - (for Model B)</p> <p>W/A/S/D Gaming Keys</p> <p>Interface</p> <p>Four USB 3.0 Ports (Including one AC/DC Powered USB Port) One eSATA Port (USB 2.0 Combo) One Thunderbolt™ Port One HDMI™ (High-Definition Multimedia Interface) Out Port (with HDCP) One Headphone/Speaker-Out Jack One Microphone-In Jack One S/PDIF Out Jack One Line-In Jack One RJ-45 LAN Jack One DC-In Jack</p> |
|---|---|--|



Specifications

| | | |
|--|--|---|
| Card Reader | Intel® Centrino® Ultimate-N 6300 3*3 (802.11 a/g/n) Half Mini-Card PCIe WLAN Module (Factory Option) | Qualcomm® Atheros Killer™ Wireless-N 1202 Dual Band (2*2 802.11 a/b/g/n) Half Mini-Card PCIe WLAN + Bluetooth Combo Module (Factory Option) |
| Embedded Multi-In-1 Push-Push Card Reader - MMC / RSMCMC - SD / Mini SD / SDHC / SDXC - MS / MS Pro / MS Duo Note: Some of these cards require PC adapters that are usually supplied with the cards. | Intel® Centrino Advanced-N 6235 2*2 (802.11 a/g/n) Half Mini-Card PCIe WLAN + Bluetooth V4.0+HS Combo Module (Factory Option) | 2.0M FHD PC Video Camera Module (for Models A & C) Dual Camera 5.0M Pixels / 1.0M HD PC Video Camera Module (for Model B Only) |
| Slots | Intel® Centrino® Wireless-N 2230 2*2 (802.11 b/g/n) Half Mini-Card PCIe WLAN + Bluetooth V4.0+HS Combo Module (Factory Option) | BIOS |
| Three Mini-Card Slots: Slot 1 for WLAN & Bluetooth Combo Half Mini-Card Module with PCIe and USB Interface Slot 2 for mSATA SSD Full Size Mini-Card Module with SATA Interface Slot 3 for mSATA SSD Full Size Mini-Card Module with SATA Interface | Intel® Dual Band Wireless-AC 7260 (2*2 802.11 a/c) Half Mini-Card PCIe WLAN + Bluetooth Combo Module (Factory Option) | One 48Mb SPI Flash ROM AMI BIOS |
| Communication | Intel® Wireless-N 7260 (2*2 802.11 b/g/n) Half Mini-Card PCIe WLAN + Bluetooth Combo Module (Factory Option) | Security Security (Kensington® Type) Lock Slot BIOS Password Fingerprint Reader Module Trusted Platform Module 1.2 |
| Built-In 10/100/1000 Base-TX Ethernet LAN | Combo WLAN (802.11b/g/n) and Bluetooth v4.0+LE Half Mini-Card Module (Factory Option) (802.11 a/g/n) Half Mini-Card Wireless LAN N1202 + Bluetooth v4.0 Combo Module (Factory Option) | Operating System |
| | | Windows® 8 (64-bit) |

| Design Feature | Environmental Spec |
|--|---|
| Rubber Painting (for some model designs) Fixed Printing (for some model designs) Intel® Rapid Start Technology Intel® Smart Response Technology Intel® Anti-Theft Technology | Temperature Operating: 5°C - 35°C Non-Operating: -20°C - 60°C Relative Humidity Operating: 20% - 80% Non-Operating: 10% - 90% |
| Indicators | Physical Dimensions & Weight |
| LED Indicators (Power/Suspend, Battery, HDD/ODD, Airplane Mode, Num Lock, Caps Lock, Scroll Lock, *Camera, TP) <i>*Camera LED is located on camera module</i> | <p><u>For Model A & C:</u> 419mm (w) * 293mm (d) * 39.3 - 49.7mm(h) 3.9kg with Single VGA Card, Battery & ODD</p> <p><u>For Model B Design Style I:</u> 419mm (w) * 295mm (d) * 42 - 54.8mm(h) 4.2kg with Single VGA Card, Battery & ODD</p> <p><u>For Model B Design Style II:</u> 419mm (w) * 295mm (d) * 42 - 54.8mm(h) 4.4kg with Single VGA Card, Battery & ODD</p> |
| Power Management | |
| Supports Wake on LAN Supports Wake on USB Supports Wake on RTC Alarm | |
| Power | |
| Full Range AC/DC Adapter – AC in 100 - 240V, 50 - 60Hz DC Output 19.5V, 16.9A (330 Watts) Removable 8 Cell Smart Lithium Ion Battery Pack 89.21WH | |

Specifications